

20  
22

# THE IN-POND RACEWAY SYSTEMS

A principle-driven, sustainable,  
advanced aquaculture production technology

---

What is it, why would you use it and should you use it?

A jointly funded project from the U.S. Soybean Export Council (USSEC), United Soybean Board (USB), Kentucky Soybean Board, and Michigan Soybean Committee.



# Forward

Dear friends, colleagues, U.S. Soy farmers and future U.S. Soy users:

It is with great pleasure that we have seen the demand for U.S. Soy continue and grow around the world. Core to our mission has been to share resources and educational content to help support expanded use of soy in every corner of that globe. Understanding that one of our greatest soybean customers is the global livestock industry and among them, a burgeoning aquaculture market, we have invested in this space.

As consumer demand for aquaculture products continues to grow, the opportunity for soy grows alongside. To support that growth, we believe a reliable feedstock is necessary. And what is more consistent and dependable than the nutritional quality of U.S. Soy? As farmers look for new solutions to meet aquaculture demand, our support of sustainable and efficient farming practices that incorporate soy-optimized diets is a critical investment.

This technology delivers on our mission of collaboration, demand growth and education of the premiere benefits U.S. Soy has to offer. We hope that every farmer looking to start or expand an aquaculture operation has access to recommendations, research and technologies that support their endeavors. And, we hope that U.S. Soy is a natural fit for their aquaculture diets.

Thank you to each of our project advisors and authors and the collaboration and investment from our soy partners. We are proud of the work we are able to do on behalf of U.S. Soybean farmers through our joint efforts.

Best of luck to each farmer who tackles this new system in their geography. USSEC is continuously improving, and we are committed to provide readers of this manual with updated information as it is developed. USSEC will continue to support you as best we can, afterall, if the consumers of U.S. Soy do well, then U.S. Soybean farmers do well.

A handwritten signature in white ink, appearing to read "J. Sutter". The signature is stylized and fluid, with a large initial "J" and "S".

**Jim Sutter**

CEO, U.S. Soybean Export Council (USSEC)



# Acknowledgments

It is with pleasure that we provide this manual for the use of readers and developers of In-Pond Raceway Systems (IPRS) located all over the world. It is our wish that you find it a useful and practical document beneficial to your business endeavors. I would like to acknowledge the consistent support from U.S. soybean farmers from across our nation in developing and extending this technology. Without their continuing support, the rapidly developing adoption of IPRS aquaculture would not likely be happening today. The strong foundation developed over decades by USSEC and aquaculture leaders such as Drs. Rud Schmittou and Mike Cremer provided the foresight critical to the successful broad acceptance of IPRS. In assembling materials and data for development of this up-dated manual, our team received contributions of information, suggestions and images from U.S. Soy Export Council, IPRS Task Force, global staff and consultants from all regions where USSEC is active. Their collective efforts were critical in the quality and development of this guide. The team assembled for organizing, writing, editing, analyzing, re-editing and all the many aspects of putting together this document, which is the culmination of work over more than 20 years duration, was extraordinary and was my great privilege to lead. I would like to thank and recognize the contributions of this team of professionals. Each member contributed in their own way into the multi-dimensional needs of putting together this document. Their abilities are many and they are:

**Mr. Esau Arana** – IPRS builder, Field Scientist and Implementation Specialist USSEC Latin America, Author Popular Aquaculture Press Articles, Teacher, Mentor

**Dr. David Cline** – Media Specialist, Organizer, Writer, Editor, Image and Illustration Communicator, Extension Specialist, Teacher

**Dr. Terry Hanson** – Economist, Organizer, Business Analysis Specialist, Spreadsheet Development, Editing, Re-Editing, Teacher, Writer

**Mr. Lukas Manomaitis** – USSEC Aquaculture Program Technical Contractor, Aquaculture and Seafood Specialist, IPRS Promoter, Field Implementation Specialist Team Lead Southeast Asia, Teacher, Leader

**Mr. Skip Kemp** – Organizer, Communicator, Sharepoint Specialist, Writer, Editor, Field Specialist in Southwest Asia and Middle East, Teacher

**Mr. Zhou EnHua** – USSEC Freshwater Aquaculture Technical Manager, Organizer, IPRS Pioneer, Field Implementation Specialist Greater China, Teacher, Leader

Each of these gentlemen have skills in many areas, but common to all are three traits which, I think, make them highly effective professionals. These traits are patience, willingness to continually listen and learn and finally, they all have the heart of a teacher. I'm confident these abilities will become evident as even the casual reader absorbs the material, facts and wisdom offered here. I'm sure I speak for all these authors when I say, "We hope you are able to use this manual to benefit your business and improve your life."

**Jesse Chappell, Team Leader**

# Table of Contents

<b>SECTION 1. In-Pond Raceway Systems</b>	<b>8</b>
<b>Section 1.1:</b> Introduction to In-Pond Raceway Systems	8
<b>Section 1.2:</b> Walk-through Key Points of an IPRS Farm	9
<b>Section 1.3:</b> In-Pond Raceway System – the Theory and History	11
<b>Section 1.4:</b> Should You Consider IPRS for Your Farm?	13
<b>SECTION 2. Design, Construction and Operation of IPRS: The Standards and Basic Principles</b>	<b>14</b>
<b>Section 2.1:</b> Overview of Factors That Give IPRS Improved Operational Efficiency and Predictability	14
<b>Section 2.2:</b> Basic Principles and Standards of IPRS	14
<b>Section 2.3:</b> Pond Design	15
<b>Section 2.4:</b> Design and Construction of Key Components	16
<b>Section 2.5:</b> WhiteWater Units – IPRS is a Flowing Water Culture System	17
<b>Section 2.6:</b> Raceway Cells (physical structure)	20
<b>Section 2.7:</b> The Production Zone (PZ)	21
<b>Section 2.8:</b> The Quiescent Zone (QZ)	21
<b>Section 2.9:</b> Knee Wall(s)	21
<b>Section 2.10:</b> Working Walkways (WW)	23
<b>Section 2.11:</b> Supplementary Aeration (SA)	25
<b>Section 2.12:</b> Balancing Systems to Pond Volume	27
<b>Section 2.13:</b> Sizing Commercial Systems / Production Potential	26
<b>Section 2.14:</b> The Baffle Wall (BW)	26
<b>Section 2.15:</b> Confinement Gates (CG) and Gate Slots	27
<b>Section 2.16:</b> Electrical and Backup Power Systems	28
<b>Section 2.17:</b> Spare Equipment and Backup Systems	29
<b>Section 2.18:</b> Waste Extraction and Management	29
<b>Section 2.19:</b> Filter-feeding or Service Species	29
<b>Section 2.20:</b> Solids Removal Equipment	30
<b>SECTION 3. Installation and Commissioning of the System</b>	<b>33</b>
<b>Section 3.1:</b> WhiteWater units (WWU)	34
<b>Section 3.2:</b> Confinement Gates	35
<b>Section 3.3:</b> Pond Bottom Preparation	35
<b>Section 3.4:</b> Knowing Water Chemistry (also, see Appendix A.)	36
<b>Section 3.5:</b> No Water Exchange	37
<b>Section 3.6:</b> Establishing a Healthy Phytoplankton Bloom	38
<b>Section 3.7:</b> Water Velocity and Exchange Rate	38
<b>Section 3.8:</b> Establishing Backup Electricity Generator	41
<b>SECTION 4. Management of In-Pond Raceway Systems</b>	<b>42</b>
<b>Section 4.1:</b> Culture Techniques, Operation and Maintenance	43
<b>Section 4.2:</b> Stocking Approach	43
<b>Section 4.3:</b> Stock Selection and Grading	44
<b>Section 4.4:</b> Staggered Stocking	45
<b>Section 4.5:</b> Management of Filter-feeding and Service Species	45
<b>Section 4.6:</b> Feeds and Feeding	46
<b>Section 4.7:</b> Feeding Practices: Ninety Percent Satiation Feeding	48
<b>Section 4.8:</b> Seasonal Adjustments of Feeding Rates in IPRS	51
<b>Section 4.9:</b> Feed Storage: Maintaining Quality	51
<b>Section 4.10:</b> Feed Mill Relationships	52
<b>Section 4.11:</b> Water and Water Quality Management in IPRS	52
<b>Section 4.12:</b> Confinement Gates	54
<b>Section 4.13:</b> Solids Removal System and Management	55
<b>Section 4.14:</b> Floating Waste Solids	60

<b>Section 4.15:</b> Fish Health Management in Raceways	60
<b>Section 4.16:</b> Fish Health Management Protocols	60
<b>Section 4.17:</b> Treatment Rationale	62
<b>Section 4.18:</b> Applying Treatments in Raceway Cells	62
<b>Section 4.19:</b> Treatments will be Applied Seasonally as Follows (Varies with Species)	63
<b>Section 4.20:</b> Notes from Experience	63
<b>Section 4.21:</b> Active Management of Fish Health	63
<b>Section 4.22:</b> Protocol for Sampling Diseased Fish for Analysis	63
<b>Section 4.23:</b> Harvesting from In-Pond Raceways	65
<b>SECTION 5. Maintenance of In-Pond Raceway Systems</b>	<b>66</b>
<b>Section 5.1:</b> WhiteWater Units	67
<b>Section 5.2:</b> Confining Gate Mesh	68
<b>Section 5.3:</b> Raceway Walls	68
<b>Section 5.4:</b> Waste Solids Removal Gear	68
<b>Section 5.5:</b> Baffle Wall	69
<b>Section 5.6:</b> Back-up Generator	69
<b>Section 5.7:</b> Electrical Switch Cabinets and Connections	70
<b>Section 5.8:</b> Programmable Feeders	70
<b>Section 5.9:</b> Replacement Blowers	71
<b>Section 5.10:</b> Feed Storage Area	71
<b>Section 5.11:</b> Power System	71
<b>Section 5.12:</b> WhiteWater Unit	71
<b>Section 5.13:</b> Supplementary Aeration System	71
<b>Section 5.14:</b> Gate Mesh	71
<b>Section 5.15:</b> Automated or Programmable Feeders	72
<b>Section 5.16:</b> Waste Collection System	72
<b>Section 5.17:</b> Waste Storage System	72
<b>Section 5.18:</b> Water Baffle Wall	72
<b>Section 5.19:</b> Exceeding Biomass	72
<b>Section 5.20:</b> Over-building the Facility	72
<b>SECTION 6. Record Keeping and IPRS Performance Monitoring</b>	<b>73</b>
<b>SECTION 7. Economics of IPRS</b>	<b>75</b>
<b>Section 7.1:</b> Introduction	76
<b>Section 7.2:</b> Economics of IPRS	76
<b>Section 7.3:</b> Investment and Construction Costs	78
<b>Section 7.4:</b> Variable Costs	99
<b>Section 7.5:</b> Fixed Costs	80
<b>Section 7.6:</b> Sales, Net Returns and Other Measures of Profitability	80
<b>Section 7.7:</b> Marketing	81
<b>Section 7.8:</b> Advanced Aquaculture with IPRS	82
<b>Section 7.9:</b> Aquaponics	82
<b>Section 7.10:</b> Polyculture and Other Revenue	82
<b>SECTION 8. Case Studies</b>	<b>83</b>
<b>Section 8.1 Case Study:</b> Tilapia (Latin America)	84
<b>Section 8.2 Case Study:</b> Tilapia (Egypt)	95
<b>Section 8.3 Case study:</b> Grass Carp (Vietnam)	103
<b>Section 8.4 Case Study:</b> China	105
<b>Case Study:</b> Grass Carp (China)	112
<b>Case Study:</b> Tilapia (China)	115
<b>Case Study:</b> Pangasius (China)	117
<b>Section 8.5 Case Study:</b> Bangladesh	120
<b>Section 8.6 Case Study:</b> India	126



<b>APPENDIX</b>	<b>129</b>
<b>Appendix A.</b>	130
Dissolved Oxygen	130
pH and Carbon Dioxide	130
Alkalinity	131
Hardness	132
Ammonia	133
Carbon Dioxide	136
<b>Appendix B. Experiences with IPRS: Some Lessons Learned the Hard Way</b>	<b>138</b>
Dos and Don'ts of Designing and Construction Lessons Learned	138
Dos and Don'ts of Installation and Commissioning Lessons Learned	139
Dos and Don'ts of Management Lessons Learned	<b>139</b>
<b>Appendix C. Glossary of Terms</b>	<b>139</b>
<b>Appendix D. Frequently Asked Questions – FAQs</b>	<b>140</b>
<b>Appendix E. IPRS Designs, Drawings, and Plans</b>	<b>148</b>
<b>Appendix F. References and Literature Citations</b>	<b>150</b>
<b>Appendix G. Contacts for Technical Assistance, Equipment, Feed, U.S. Soy</b>	<b>153</b>
<b>Contacts for Technical Assistance</b> (Placeholder for official list from USSEC)	153
<b>Approved IPRS Equipment Suppliers</b>	<b>153</b>
China, India, Pakistan and Bangladesh	153
United States of America	<b>153</b>
<b>Appendix H. Potential Variations and R&amp;D of IPRS</b>	<b>154</b>
<b>Appendix I. Link Between IPRS and U.S. Soy Farmers</b>	<b>154</b>
Why is IPRS Important to U.S. Soy Farmers?	154
The Important Link Between High Quality Feeds and IPRS Performance	154
<b>Appendix J. USSEC Trial Diet Formulations</b>	<b>156</b>
Several Species with Different Dietary Requirements	156
USSEC Trial Diet Formulation for Rainbow Trout (48/10)*	156
USSEC Trial Diet Formulation for Largemouth Bass and Snakehead (45/8)*	156
USSEC Trial Diet Formulation for Tilapia and Channel Catfish Fingerlings (36/7)*	157
USSEC Trial Diet Formulation for Tilapia & Channel Catfish Growout (32/6)*	157
USSEC Trial Diet Formulation for Grass Carp Growout (32/3)*	15
USSEC Trial Diet Formulation for Pangasius Growout (28/4)*	158
USSEC Vitamin Premix F-2	158
USSEC Mineral Premix F-1223	
USSEC Calculated Nutrient Profile of U.S. soy-based (32/3) trial diet	159
USSEC Calculated Nutrient Profile of U.S. soy-based (32/6) trial diet	159
USSEC Calculated Nutrient Profile of U.S. soy-based (28/4) trial diet	160
<b>Appendix K. USSEC Trial Diet Formulations</b>	<b>160</b>

## NOTE TO READERS

**This manual explains the In-Pond Raceway System (IPRS), its development and how to manage the system while growing fish.** The intended audiences are those who currently operate IPRS to give a greater understanding of the concepts, principals, details and trouble areas; and to the newcomer to IPRS technology. Both audiences will benefit from this detailed manual. An earlier manual has been updated because of the vast growth of IPRS usage, especially in China, SE Asia, and now, in other regions of the world, knowledge gained from completed IPRS construction sites and production results from numerous fish crop cycles. This accumulated knowledge has allowed us to produce a manual that is full of insights on proper management as well as IPRS construction, maintenance, production, economics and many other topics that the current and future user of IPRS will find invaluable. As you develop and produce fish in your IPRS, we would like to hear from you on your experiences and insights that would improve this manual for a future update.

**- Dr. Jesse Chappell, Skip Kemp, Dr. David Cline, Esau Arana,  
Dr. Terry Hanson, Lukas Manomaitis and Zhou Enhua**

**For more information about IPRS, contact [IPRS@ussec.org](mailto:IPRS@ussec.org).**

# SECTION 1

**In-Pond Raceway Systems**



## SECTION 1.1: Introduction to In-Pond Raceway Systems

In-Pond Raceway Systems (IPRS) are an advanced approach to pond aquaculture that combines the management benefits of confining fish in a small portion of the pond with the production capacity of a flowing water system. IPRS creates a flowing “river in the pond” and allows the water to mix and move as it would in a riverine system. This flowing water significantly increases the pond’s production potential.

To create the flowing water, the IPRS utilizes components that when combined, mix and move the water in a circular pattern around a dividing partition (baffle) in the pond, effectively recycling and refreshing the water and preventing discharge into the local environment.

This system lowers per unit production costs, reduces risk and significantly improves yield. IPRS operate with simplicity and in harmony with nature to offer greater predictability and profit potential than conventionally operated ponds. The IPRS technology offers the potential to double, or even triple, yields beyond traditional pond expectations (up to 70-80 tons per hectare in tropical climates) with no discharge of water or waste into local waterways. IPRS is a more manageable, controllable approach allowing high yields and reduce environmental impact.

Since the United States Soybean Export Council (USSEC) introduced IPRS in China in 2013, nearly 9000 systems have been developed across 18 countries. In this manual, you will learn about the approach, principles and management actions that make IPRS successful around the world.

## SECTION 1.2: Walk-through Key Points of an IPRS

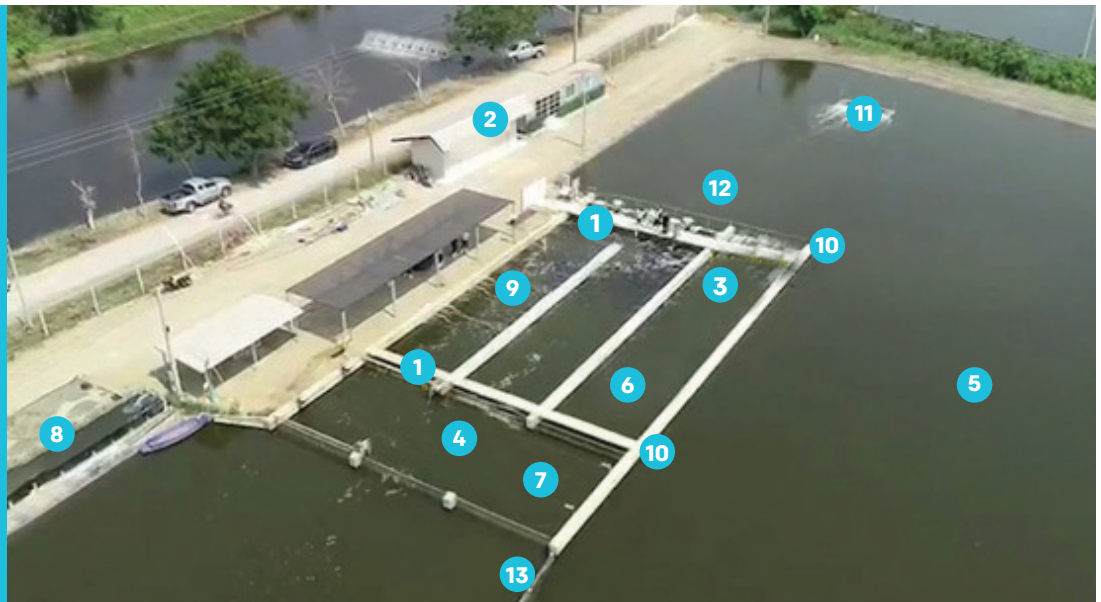
**The key elements of the IPRS include:**

- 1. WhiteWater Units (WWU) are electrically powered, high-efficiency airlift water movers that aerate, mix and circulate the water through the raceways and around the pond.** Electricity supply must be reliable and constant (with auto-start back-up electrical generator in place) for IPRS success.
- 2. Elongated, rectangular raceways installed in parallel along the longest side of the pond.** These raceways are the structures that confine the primary fed production species and provide easy access to manage (stock, feed, harvest, sample etc.) the fish.

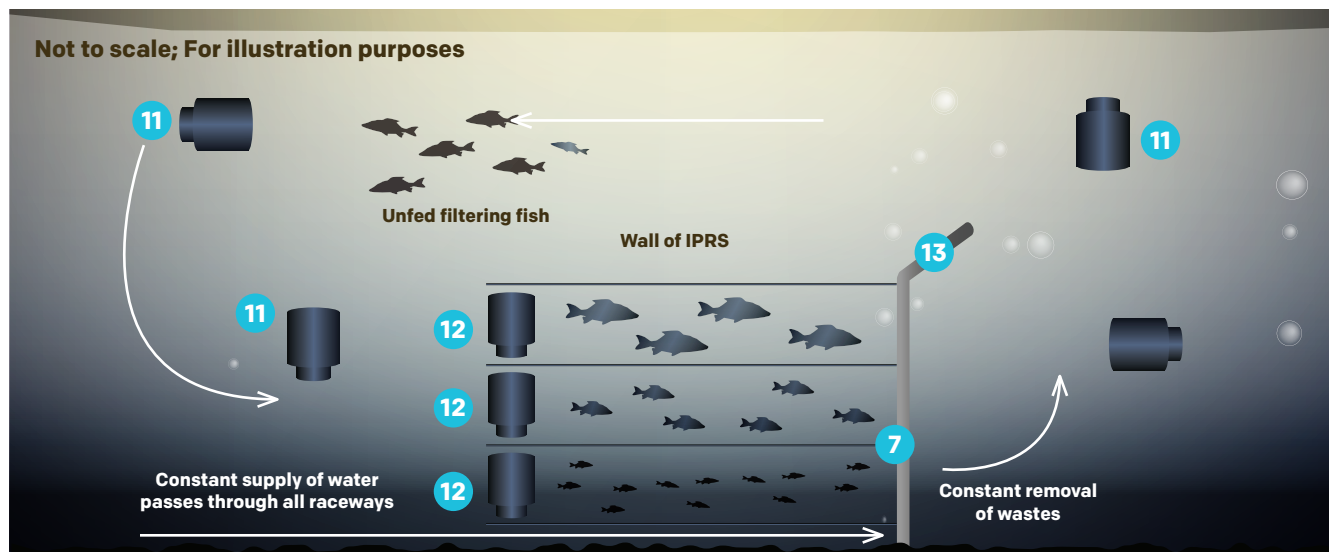
**Figure 1.** Overview of the USSEC Standard IPRS farm labeled with key components

### Key for Figures 1 & 2

1. Confinement Gates
2. Feed Storage
3. Mechanical Auto-Feeder
4. Mechanical Solid Waste Removal
5. Open Pond Area
6. Production Zone (PZ)
7. Quiescent Zone (QZ)
8. Solid Waste Removal
9. Supplementary Aeration (SA)
10. Working Walkway
11. WhiteWater Unit (Open Pond)
12. WhiteWater Units (Raceway head)
13. Baffle



**Figure 2.** Flowing water principle “River in a pond”



Mesh panels called “confinement gates” on each end of the raceways facilitate water flow while holding fish in the raceway. Free roaming, unfed filtering species in the open pond add to the production volume and value.

3. **A quiescent zone (QZ) at the tail end of the raceways is structured for waste solids to settle and are collected and removed using a vacuum pump.** This removes a major portion of the organic waste that would otherwise have to be assimilated by the pond and makes it available for further value-added use.
4. **A baffle running down the middle of the pond that forces the water to fully circulate around the pond before returning to the raceways.** This allows the oxygen-rich, flowing water together with the natural pond organisms to significantly speed up the assimilation of organic wastes that are produced from feeding the fish.
5. **The open pond is often overlooked, but is the most important component of the successful IPRS.**

Described later, all biological nutrient assimilation and breakdown of organic matter occurs in the open pond. These processes rejuvenate and condition the water for passing through the raceways.

6. **An auto-start back-up generator is a critical element of IPRS operational success.** In all areas electrical power interruptions occur, so operators install appropriately sized electrical generator(s) to provide electrical energy needed when line power is temporarily interrupted. This gear is tested and operated weekly to assure its ability to start automatically and provide the necessary power for specific IPRS gear.
7. **IPRS ponds are designed and equipped with a waste collection and removal system** which dramatically reduces organic loading within the pond environment. These operate at intervals on a programmed basis to remove settled solids and deposit them in onshore temporary storage vessels. Storage vessels are emptied frequently and materials recycled.

8. **Confinement gates are fence-like equipment at the head and tail ends of the production zone designed to eliminate fish escaping from the production zone (PZ).** The durable mesh should be heavy-duty stainless-steel mesh of a size that can retain the smallest fish stocked, yet large enough to enable free flow of water through the raceway.

Working together, these elements facilitate a highly productive culture environment that offers many advantages over traditional pond culture. The decision to move towards this advanced technology should not be taken lightly as there are many economic, structural and managerial changes that must occur. For these systems to be successful, farmers and entrepreneurs must be willing to commit to the new management style and provide the required inputs as specified in this document. The specifics of these requirements are detailed herein along with nuances of construction, management, financial and economic planning. IPRS offers great potential, and it is being successfully adopted and adapted in numerous countries, climates and cultures.

## SECTION 1.3: In-Pond Raceway System – The Theory and History

Development of modern advanced and intensified pond production system technologies began in the United States in the late 1980's at Auburn University, Clemson University and later at Mississippi State University. Early models were only research-scale and crude but they began to establish the principles that are used in today's IPRS. Dr. David Brune, et.al (2004). at Clemson University focused on what they termed "Partitioned Aquaculture Systems" or PAS. Their approach sought to minimize water volume and used slow moving solid paddlewheels to mix and direct water around the pond. The approach by Drs. Mike Masser and Andy Lazur (2004) at Auburn University was developed around a small floating raceway. Their approach used small airlift tubes to actively exchange water in the raceway from the pond where it was installed.

In the late 1990's, Dr. Craig Tucker et.al (2016). initiated work at

the Thad Cochran Aquaculture Center in Stoneville, Mississippi in collaboration with Dr. David Brune at Clemson University (Brune et al, 2012). Their efforts further developed the Partitioned Aquaculture System initiated at Clemson several years earlier. All the early iterations used some form of water movement, mixing and heavy aeration to accelerate waste assimilation and enhance pond yields of channel catfish.

The two images represent much of the actual commercial scale in-pond raceway system (IPRS). Research and development work at Auburn University was sponsored by the Alabama Cooperative Extension System (ACES), Alabama Catfish Producers Association (ACPA) and later by the U.S. soybean producers via the industry checkoff program. The U.S. Soy industry has continued to be the major sponsor of development for this modern approach to pond aquaculture both in the U.S. and internationally.

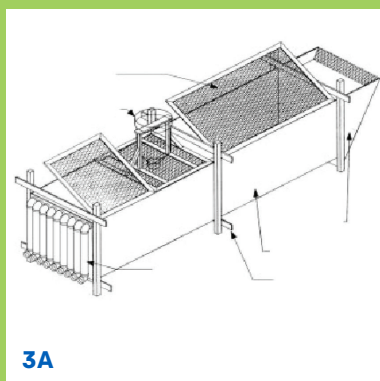
Beginning in 2003-2004, Auburn University initiated a new phase of advanced pond culture using in-pond raceways with a focus on development of commercial-scale raceway technologies to be

industrially viable and improved the profit potential for aqua-farmers. With support from ACES and ACPA, eight years of research and demonstration of IPRS was conducted primarily in the southeastern United States.

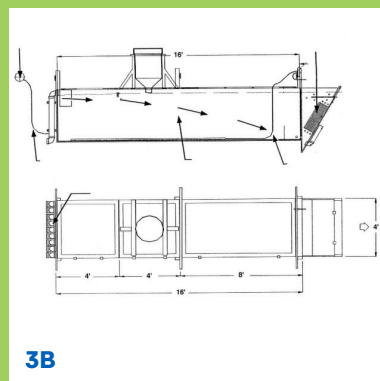
The work at Auburn University sought to follow examples found in raceways where trout are cultured using high quality spring water as it flows down a mountain slope or similar terrain. Production yields from these systems and ease of management of the fish stocks were striking. Auburn researchers sought to mimic natural river flow and find ways to adapt this feature in commercial pond production. Raceway structures were modified to use flowing water pushed through the raceway and around the pond as a flowing water or mixed system.

Over several trials, WhiteWater Units (WWUs) were developed which, at a low operational cost, continually mix, aerate and push water through the raceways and around the pond. This continual riverine flow is visible at nearly all points around the pond. During the Auburn trials, researchers Drs. Jesse Chappell, Terry Hanson, Kubitzka, Arana (2017), Roy et al. (2019), and Bott et.al (2015) were able

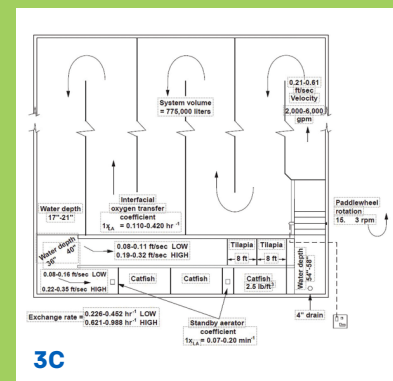
**Figure 3A & B.** Sketch and plan view of early small-scale In-Pond Raceway models developed by Drs. M. Masser and A. Lazur (2004) at Auburn University. **Figure 3C.** The partitioned aquaculture system designed at Clemson University evolved into the IPRS technology.



3A



3B



3C



**Figure 4.** Picture of early commercial IPRS in Alabama in 2005, utilizing paddlewheels to move water



to determine appropriate approaches to use of equipment and components including development of WWUs, ratios of water volume to number and volume of the raceways to install for reliable and predictable production. Several trials in Alabama commercial catfish ponds indicated significant improvements in efficiency and yield performance over traditional management when using IPRS.

In 2011-2012, the U.S. Soy industry farmer leaders, with guidance from Dr. Michael Cremer, began a comprehensive effort to extend the

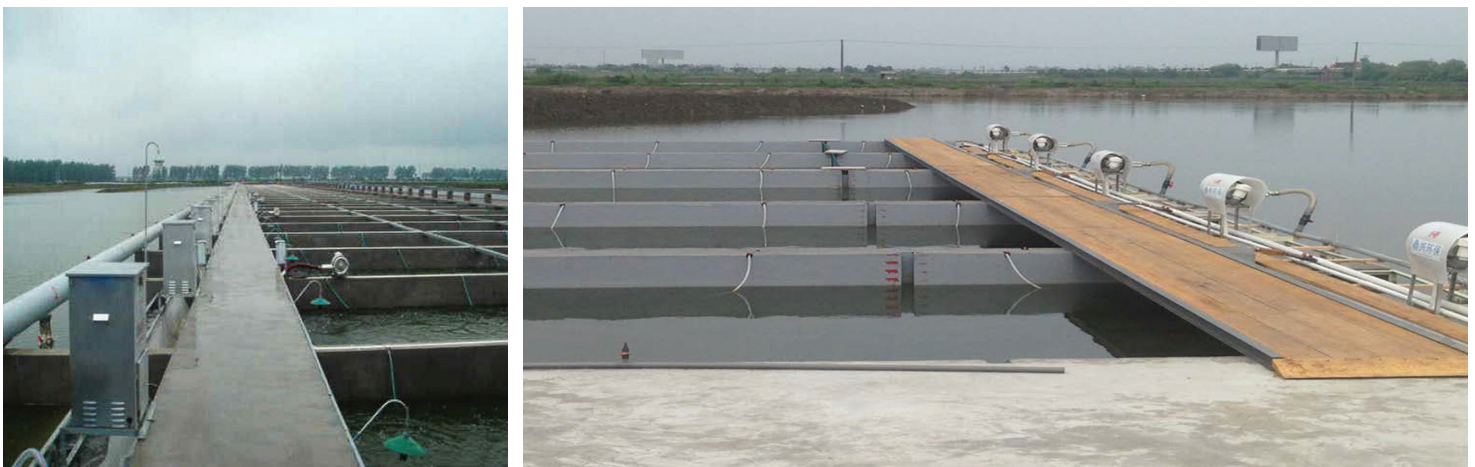
IPRS technology to major markets where U.S. grown soybeans were sold for development of soy-based fish feeds. The effort to extend the IPRS to international customers began in 2012-2013 in China, the largest U.S. Soy user. The USSEC aquaculture team and contractors have made great improvements in upgrading and standardizing the basic IPRS technology and protocols for adoption by the global aquaculture industry. Improvements in design, construction, components, equipment, gear and devices for more efficient operation of IPRS

have been made since 2013 when the first IPRS demonstration was successfully conducted in China. It was in China where the USSEC IPRS technology was widely promoted and adopted using U.S. Soy optimized diets for fish. Since then, it has been successfully introduced globally through the USSEC World Wide Aquaculture Program.

Since beginning in China, IPRS technology has been adopted in more than 18 countries. Typical adopters and users of the IPRS technology are buying nutritious feeds that utilize high quality, U.S. grown soy products and are successfully culturing more than 25 species of fish and shrimp bound for global markets.

The primary and ongoing objectives of USSEC and this manual is to encourage and support the adoption of IPRS technology to improve production efficiency and economic opportunity available to producers culturing fish in ponds both in the U.S. and the global aquaculture community. Use of high-quality floating diets including U.S. Soy as the primary protein source has been featured as an operational principle on IPRS.

**Figure 5.** Examples of modern IPRS raceways and WWUs



## SECTION 1.4: Should You Consider IPRS for Your Farm?

Candidate IPRS adoptees are encouraged to consider the following constraints. Each of the following critical criteria must be met to capture the benefits of IPRS and success according to USSEC-proven and recommended IPRS management guidelines.

**A. Existing or planned ponds must have sufficient water volume to construct a minimum of two, but optimally three, raceway cells.**

Two cells for production and a third optional for stocker development. Of course, stockers may be developed in other ponds, tanks or raceways. The minimum pond volume for this system is 30,000 m<sup>3</sup> of water including a minimum depth of 2 meters (for 3 raceways). There are several ways to reach this volume regarding pond surface area and depth. The volume drives the number of raceways to install. Farms with small ponds have the option to combine multiple adjacent ponds to achieve this volume.

**B. The farm's electrically powered components require a stable supply and must have a reasonable expectation of infrequent down times.**

An emergency auto-start generator is an essential component and must be of sufficient size and rating to start and run the primary operational equipment in the event of electrical power outages.

**C. The farm must have access to high quality fingerlings of the correct quantity, size(s) and species to stock all raceway cells.** Farms initiating IPRS management need to plan with fingerling suppliers well in advance because the numbers of stock needed are significantly greater than for traditionally managed ponds. As an alternative, the farm may develop a comprehensive plan to source the desired fry of sufficient quantity and quality with a plan to nurse them to appropriate size in a nursery system or adapted IPRS raceway cell.

**D. The business must have access to sufficient capital to plan, correctly and fully construct the IPRS raceway cells as well as purchase associated equipment (including backups).** Additional capital must be available for operational costs such as the purchase of fingerlings, the correct quality and quantity of feed, electrical power, labor, etc. and plan for other operational contingencies.

**E. The success of the business and the performance of IPRS depends on carefully following the principles set forth below to facilitate the enhanced efficiency and yields described.**

- If the standards outlined are followed, users should see the performance stated.
- Not following the correct standards and/or not understanding and following the principles will lead to reduced performance, impact profitability and increase the likelihood of business failure.

**" This technology is for anyone wanting to do profitable aquaculture, and at the same time, is willing to work to improve the environment. "**

Dr. Jesse Chappell

**For more information about IPRS, contact [IPRS@ussec.org](mailto:IPRS@ussec.org).**

# SECTION

## **Design, Construction and Operation of IPRS: The Standards and Basic Principles**

The design, construction and specific components used in current IPRS are based on research and development as well as commercial use and experience over more than 25 years. This technology is an advanced pond production technique using specific equipment to create and maintain the pond as a flowing water system. By following the standards and principles we outline in this manual, IPRS will allow annual yields 200-300% greater than traditional ponds.

# 2



## SECTION 2.1: Overview of Factors That Give IPRS Improved Operational Efficiency and Predictability

- **IPRS uses regularly shaped ponds that are 2-3 meters in average depth;** deeper ponds require modification of equipment and management different from standard IPRS approaches; ponds deeper than an average of 3 meters need to use gear designed to more aggressively and vertically mix the water column top to bottom. Specific gear recommendations can be made for ponds deeper than 3 meters that aggressively mix the water column with low horsepower equipment.
- **Ponds with volumes larger than 30,000 m<sup>3</sup> are more efficient than smaller ponds for installing and operating IPRS.**
- **One standard raceway consisting of a 220 m<sup>3</sup> production zone requires 10,000 m<sup>3</sup> of pond volume;** and pond volume determines how many raceways should be installed for maximum productivity and economic return.
- **No water exchange is needed for managing IPRS ponds;** only evaporation and seepage water losses are replaced.
- **Reliable 24/7 electrical current must be present at any viable IPRS farm or installation.**
- **Auto-start back-up generator(s) are required** for providing electrical energy to operate water mixing and aeration gear (WWUs) in the event of a power disruption.
- **Fingerlings for stocking IPRS raceways should be uniformly sized and free of parasites and disease,** prophylactic treatments for control of disease should precede transport and stocking into raceways. They should be the same age with good genetic quality because any inbreeding will significantly decrease growth rate by about 20%.
- **Use a staggered stocking approach, that is, stock small, medium and larger size fingerlings** in different cells to avoid having all raceways ready to harvest at one time; this also reduces the daily feed volume fed into the pond.
- **Only high-quality extruded diets with appropriate nutrients are used in feeding** the wide variety of fish cultured in IPRS raceways; feed pellet size must be appropriate for the smallest fish stocked.
- **Feeding fish in raceways can be done by hand or by programmable auto-feeders;** a 90% of satiation feeding strategy for optimal feed efficiency is strongly encouraged.
- **No feed is provided to service fish (filtering) species stocked in the open pond.** They are used to graze organic material and biota created by unused or excreted nutrients in the pond.
- **Harvest of fed species and service species is scheduled for fish only when biomass and fish individual weight reach optimal target;** fed species are harvested

without any size selection, service species can be harvested (selectively if desired) anytime stock reaches market target weight. Using partial harvests and grading of fed species during the cycle are strongly discouraged due to stress put on the fish.

- **Maintenance of equipment and gear is required;** standby generator, blowers, air filters, lubrication points, fish confinement gate mesh, valves, joints, fittings etc. are required; a detailed maintenance schedule is an operating principle of IPRS.
- **Detailed record-keeping for IPRS facilities provides highly valuable data for the operation that can be used to evaluate the systems performance and pinpoint areas needing adjustments;** therefore, it is a required operational principle.
- **Safety for workers and operators is practiced in design, construction and operation of IPRS.**

## SECTION 2.2: Basic Principles and Standards of IPRS

This Manual and approach for advanced pond production technology is designed and focused on **Fixed-floor Freshwater IPRS only**. At this writing, use of IPRS, and its technologies, are not recommended for marine systems due to several severe issues particularly with structural materials failure and biofouling.

## SECTION 2.3: Pond Design

### Standards-specific pond characteristics and principles, especially in newly constructed or planned ponds, for applying IPRS technology are:

**1. Average depth - 2.0-3.0 meters;**

while pond volume is important in IPRS technology, we do not recommend constructing new ponds with average pond depth greater than 3.0 m.

**2. Levees around the pond should have width to height slopes of 1.5:1 or flatter for minimal erosion and long life.**

Levees constructed with steep slopes with erode quickly if not protected. A better business approach is to build levees with at least a 2:1 slope for a longer useful life.

**3. Pond levees with steeper slopes should incorporate some means of stabilizing soil.**

These may include interlocking concrete panels, HDPE sheet or membrane with UV protection for prolonged life of the material. Any exposed area should be covered

with a non-erodible material or planted with grass to reduce soil movement.

**4. Ponds should be rectangular in shape ideally with a long side to short side ratio of approximately 3:1.**

Ponds that are long relative to their width (>4:1 length: width) create unnecessary circulation challenges for IPRS.

**5. Levees and pond bottom should be smooth and regularly shaped to best take advantage of flow and mixing patterns initiated and maintained by IPRS hardware.**

**6. Avoid building deep areas within the pond (>3.5m) which comprise more than 2-5% of pond floor area.**

IPRS facilities are not located in the deepest portion of the pond.

**7. Minimum pond volume (L x W x D) should not be less than 30,000 m<sup>3</sup>.**

Discussed in greater detail later in the document, this volume will allow for the construction of three IPRS raceways.

**8. Site selection, location and construction of IPRS cells should facilitate access to road, electrical utilities, operational personnel, feed and harvest transportation.**

**9. The volume of standard production raceway cells (production zone) is 220 m<sup>3</sup>.**

Each cell requires 10,000 m<sup>3</sup> of pond volume for processing the waste load generated by the fish. Maximum biomass recommended in this manual is no more than 150 kg/m<sup>3</sup> for food fish and 125 kg/m<sup>3</sup> for fingerling or stockers per cycle. These densities are species dependent. More sensitive species should be stocked at reduced densities to optimize survival and growth.

**10. IPRS use a continual flowing water approach adapted to pond culture.**

Raceway cells are installed along one levee within the pond where the fish are confined and cultured for market or development of stocker sized fish. The confined fish are fed high quality extruded diets. No other supplements or agricultural by-products should be added (plant leaves, chopped vegetation, cracked grains, etc.). The flow through the raceway cells and around the pond is continually maintained. A baffle is installed to direct flowing water around the full volume of the pond and is used to aid and facilitate mixing of the water column.

**Figure 6A.** Pond reconstruction showing pond bottom leveling **6B.** Slab construction with rebar posts **6C.** Construction nearing completion



**11. Water moving and mixing devices (WWUs) are installed on the head of each raceway as well as one strategically located in the open pond.** For each raceway and the associated WWU installed on it, there is a corresponding WWU installed in the open pond. These devices initiate and maintain the water flow also termed “river in a pond” that is descriptive of IPRS. This flowing water is the one of the main differences between traditional and IPRS ponds. The water and all the organisms within it are used more effectively to process the waste load created by feeding and growing the fish.

Oxygen-rich water enhances the breakdown of the liquid and solid fish waste as well as decaying organic debris produced by nutrients not captured by the fed fish. The rapid rate of breakdown of these materials by oxygen rich water populated with living, healthy and growing biota make IPRS possible and profitable for those who follow the principles.

**12. The target biomass level with most food fish cultured in IPRS cells is typically 33,000 kg per cycle.** As this preferred maximum biomass is reached, it is recommended that the fish in the cell are harvested and marketed to avoid unnecessary risk and over taxing the pond. After the harvest event, any necessary maintenance is completed, and the next group of fingerlings or stockers is introduced into the raceway just harvested. (This target biomass may be different for various species and climates).

**13. Redesigning several small ponds to form a single large pond is often recommended.**

**In previous years, many farms created small ponds for a variety of reasons, but when using modern aquaculture systems and technologies like IPRS, larger ponds are significantly more economical to manage and operate.** Levees can be reconfigured and shaped to form a perimeter levee of the desired size based on topography and manager preferences. The optimum size may be different for each farm. If abundant soil is available, it can be used to form the baffle levee structure (which causes water flow to pass around the full pond area). The redesigned pond(s) must adhere to the recommended slope, depth and volume requirements described above.

## SECTION 2.4: Design and Construction of Key Components

The work area footprint (within and around the pond) should prioritize personnel and vehicular access and proximity to reliable electrical power. Because electricity is required on a continual basis, delivery of electrical energy to all IPRS sites on a farm should be planned with care and consideration for adding more IPRS facilities over time. The IPRS facility is located at a readily accessible part of the pond levee that often serves as a roadway. In a multiple pond scenario, or where future expansion is planned, the IPRS are often placed so that adjacent ponds can share a common roadway levee, creating a mirror image of raceways. This development strategy allows excellent economy especially with electrical fixtures, controls and back-up generators.

## SECTION 2.5: WhiteWater Units — IPRS is a Flowing Water Culture System

Maintaining a consistently well-mixed, moving-water pond is critical to the accelerated processing of the waste load resulting from heavy feeding and increased production. Using WhiteWater Units (WWU) attached to the raceways, as well as additional WWU's placed strategically within the pond, are operated on a continuous basis to optimize mixing and water movement. Continually mixing the production unit modifies plankton species dominance and stability, (Kubitza, et. al. 2017) enhances beneficial bacteria and accelerates the rate of waste load assimilation. It also moderates the highs and lows of oxygen and biological activity experienced in traditional commercial aquaculture ponds. The main elements regulating the assimilation rate of waste are oxygen, pH and temperature. We have little ability to impact water temperature in larger commercial ponds other than increasing pond depths to allow for slightly cooler summer pond temperatures. Essentially, the IPRS approach is to use electrical energy to operate aeration and mixing equipment to create and maintain an aerobic pond water volume to efficiently and continually process the waste load developed by feeding the fish. Other equipment in IPRS is operated to collect and remove as much of settled waste solids as practical. WWUs are essentially large airlifts. Electrically powered blowers are used to deliver high volumes of low-pressure air to submerged air manifolds equipped with attached diffuser tubing. Blowers are typically called



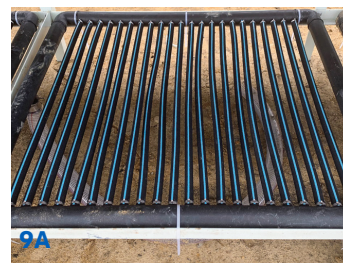
“regenerative blowers”. They require low energy input relative to air volume delivered to the diffusers (2.25 cubic meter/m/hr.). The diffuser, “Colorite Aerotube”, is a rubber composite and highly efficient, porous tube designed for air diffusion in shallow water. Diffuser tubes are mounted on the manifold racks at 6-7 cm spacing. The diffuser racks are attached to a floating frame and are fixed underwater at approximately 0.9-1.2 meters. Most (5-meter wide) WWUs are now equipped with four easily removable diffuser racks which can be exchanged for routine cleaning and maintenance. The large stream of small air bubbles released from each diffuser tube rises in the water column under a confining hood like

an airlift used in an aquarium or hatchery but on a much larger scale.

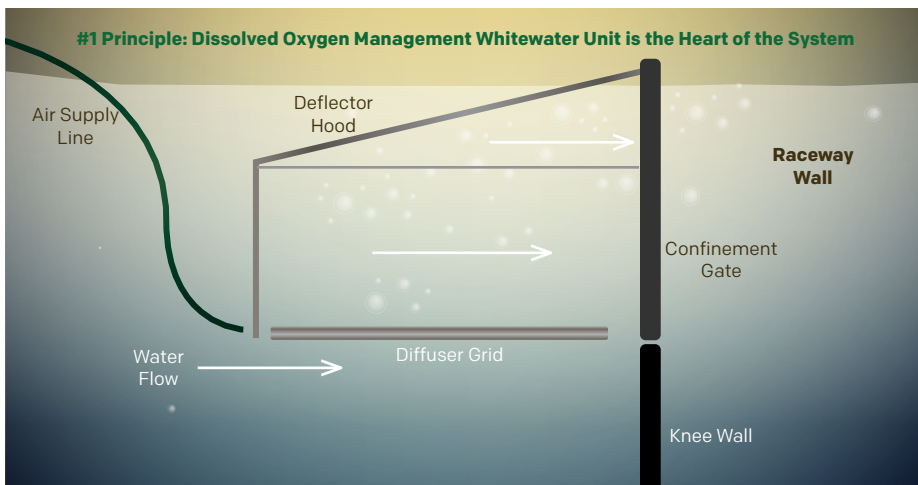
The WWUs are often attached to the raceway cell but remain free-floating so they can adjust to any change in water depth relative to static equipment. No moving parts are located underwater, and this significantly reduces the need for repairs. Each raceway is equipped with a single WWU at the head of the channel. For each raceway WWU, a corresponding WWU is installed away from the raceway at strategic and complementary locations around the pond to assist with mixing, aeration and establishing a continual flow. WWUs’ efficient operation and low annual operation and maintenance costs, relative to other types of

aeration and mixing equipment, strongly offset the initial cost of the system and associated gear. We use high quality feeds and systems to create a high-quality environment, so the animals grow more efficiently to their genetic potential and at a reduced cost per ton of yield.

**Figures 9A & B.** Examples of well-made and factory-made diffuser racks and proper connections  
**Figure 9C & D.** Examples of first-time, farm-built diffuser racks—they DO NOT PROVIDE the utility or uniform air diffusion required by IPRS



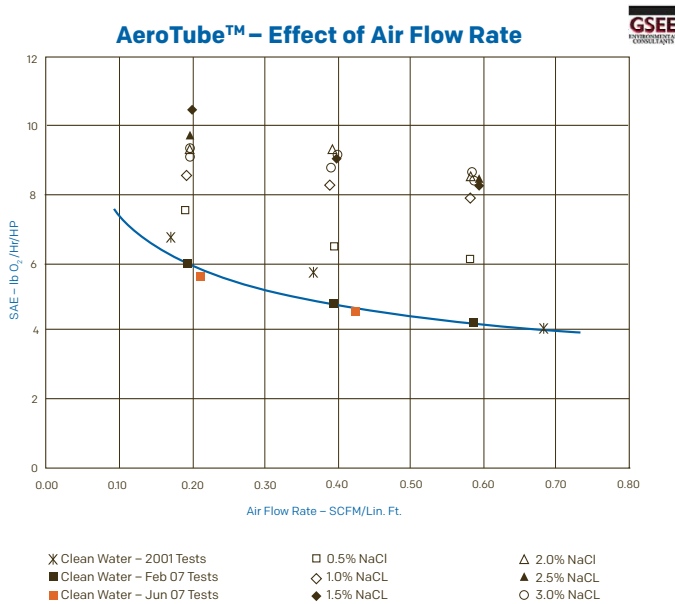
**Figure 7.** How the WhiteWater Unit works



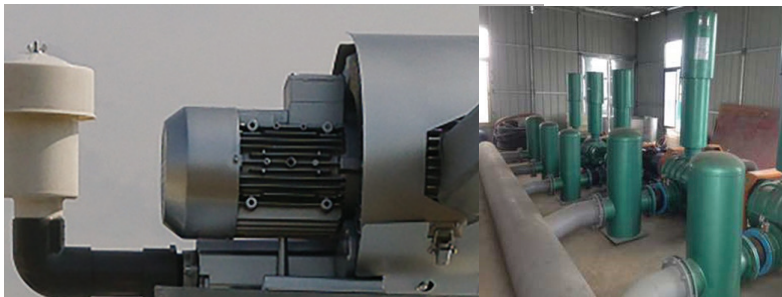
**Figure 8.** Modern WhiteWater Unit with 4 grid sections



**Figure 10.** Detail for air delivery per meter of Aerotube diffuser; 50 and 60Hz, HP

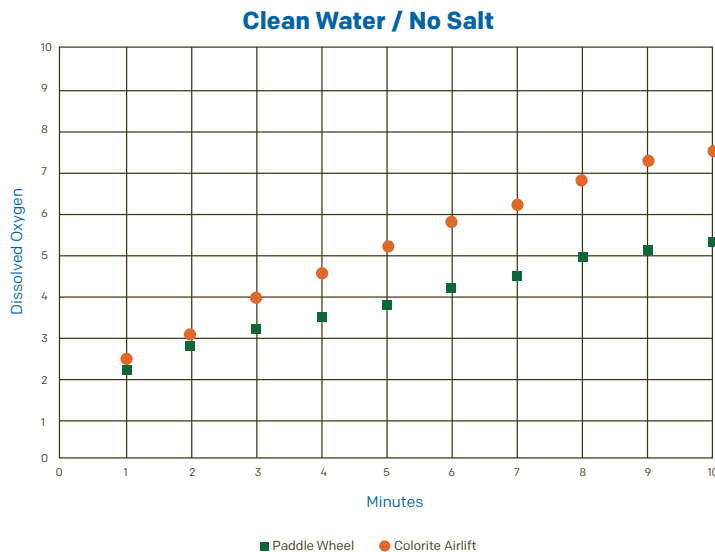


**Figure 11.** Two stage blower and filter



**Figure 12.** Rotary Lobed or “Roots blower”

**Figure 13.** Performance trials illustrating SOTR comparing Aerotube with paddlewheel



*Note: Aeration efficiency typically requires small bubbles which will remain in the water column for as long as possible before re-entering the atmosphere. Using IPRS technology with efficiency requires an optimal balance between energy use and aeration efficiency. Standard Aeration Efficiency (SAE) and Standard Oxygen Transfer Rate (SOTR) parameters need to be determined and evaluated on any diffuser and blower combination to determine its performance. In addition, the Actual Aeration Efficiency (AAE) should be factored into the real-world application. The percent saturation of water determines how much oxygen can actually be added. Supersaturated water cannot be further oxygenated and any agitation will release oxygen from the water into the air.*

For example, when surface water is super-saturated with dissolved oxygen (a condition that sometimes occurs in late afternoon on windless days) floating paddlewheel aerators actually remove oxygen from the water and release it into the atmosphere. Conversely, the WhiteWater Unit, a diffuser airlift aerator operating with hypoxic waters from near the pond bottom is much more efficient aeration and actually adds dissolved oxygen to the sub-saturated water.

## SECTION 2.6: Raceway Cells (Physical Structure)

The recommended standard structure for IPRS raceway cells is 5m wide x 2.3 m deep x 30m long rectangular boxes with each open end fitted with a mesh or grille panel to confine the fish. Each cell is comprised of three segments. First, the Connection Zone (CZ) for placement and attachment of the floating WWU uses 2 meters of wall length. Second, the Production Zone (PZ) consists of the upstream and downstream confinement gates separated by a 22-meter raceway segment. Third, the Quiescent Zone (QZ) is the remaining 6-meter portion and furthest downstream part of the cell that functions as a passive settling area for solids excreted by fish, other organic particles and any other settleable debris. The QZ is a common area which is oriented at 90 degrees from the axis of IPRS cells. Original designs for the QZ used 3 meter-long segment for solids settling, but updated designs incorporate a 6-meter segment for increased solids collection and removal. The raceway floor is formed as a flat, smooth concrete surface throughout the full 30-meter length.

**Raceway cell walls** are typically constructed on a concrete footing formed in and on the pond bottom. The wall closest to the levee is located at the toe of the levee and runs parallel to its length. Each successive wall is based upon this starting point. The pond bottom is leveled to accommodate all weather work on the site and a grade is established so that the finished raceway floor will be slightly above the pond bottom elevation (10-12 cm above grade). Because the weight of the wall is significant, the footing base is critical to the strength and longevity of the wall structure.

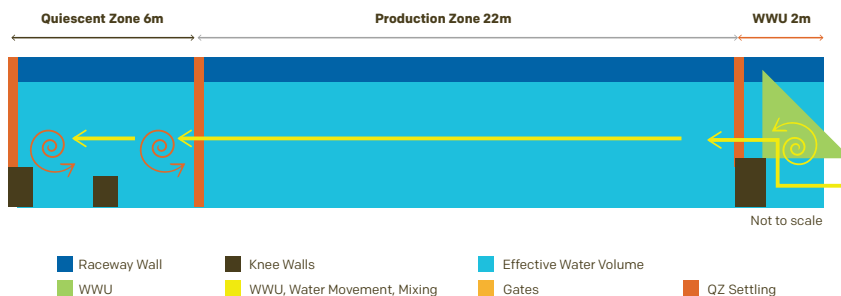
The footer dimension depends upon the type and stability of the pond soils, but generally, a 60 cm wide and 50 cm deep, reinforced concrete footer is poured to form this base the full length of the wall. Reinforcing steel rods (1.5 cm rebars) are employed to strengthen the base and connect to the vertical wall. At intervals of 3-4 meters, a vertical formed concrete post is formed into the wall to provide additional strength needed for the structural integrity of the wall. Rebar segments are left extending from many points along the footer to make a hard connection with the raceway bottom. After the walls and downstream quiescent zone is complete, the raceway bottom is then poured at a thickness of 10 cm.

Steel mesh wire or cut fiberglass is usually employed to strengthen and reinforce the bottom. The raceway bottom is formed as a flat, smooth surface as it connects to the QZ on the same grade and surface finish.

**Figure 15A – E.** A group of photos showing the development of a three cell IPRS



**Figure 14.** Side view of labeled sections of standard raceway. See Appendix E. for three isometric and plan view drawings





The planned elevation of the wall top relative to the perimeter levee is important. The raceway wall height is established 25-30 cm greater than the perimeter levee height to avoid submersion (and fish escape) during heavy rainstorm or flooding events. If this is not possible or practical, the perimeter levee should have a built-in spill-over to accommodate high volume water discharge to avoid overflowing the pond. Materials for construction of raceway walls need to be durable and structurally strong. Farmers construct walls from concrete block, brick and mortar, formed concrete, fiberglass reinforced plastic (FRP), fiberglass and High-Density Polyethylene (HDPE). Wall thickness ranges from 25-30 cm depending on materials used.

## SECTION 2.7: The Production Zone (PZ)

The PZ is 22 meters long, 5 meters wide and 2.3 meters deep. The working water depth in the raceway is 2 meters. Therefore, the PZ volume is 220 cubic meters. The PZ walls and floor are texturally smooth and flat to facilitate water flow and harvest operations. Fed species are restricted to this zone and no feed is offered to fish outside of the PZ.

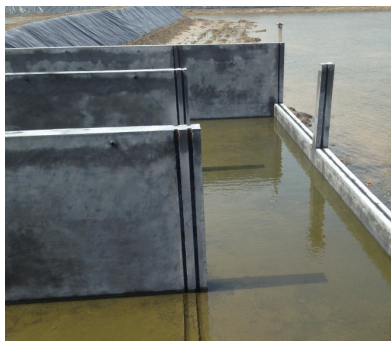
**Figure 16.** Production Zone at feeding time



## SECTION 2.8: The Quiescent Zone (QZ)

The QZ is located at the downstream end of the raceways. It is common across all adjacent cells. The updated 6-meter long QZ is bisected lengthwise by a low partition with a width of 25-30 cm and height of 25-30 cm. This partition acts as a physical separation for the two solids removal devices which are installed for solids removal from within the QZ (See Waste Removal section).

**Figure 17.** Placement of double slots in race wall and bottom in the QZ



Slots are formed in the raceway walls and bottom to accommodate and secure fish confinement gates located at the upstream and downstream ends of each raceway cell. Two slots located 30 cm apart are formed with a width dimension of 6-7 cm wide and 6-7 cm deep. The slots are parallel and extend from the top to the bottom of each wall and likewise across the cell floor or top of upstream knee wall to connect to corresponding slots on the opposite side wall.

Additional slots are formed along the wall top to accommodate air delivery tubing for supplementary aeration of the cell. This slot can be formed as a single 10-12 cm wide

slot or as two slots each 5-6 cm wide. Both slots are 5-6 cm deep on the wall top.

**Figure 18A & B.** Slots for supplementary air delivery system



## SECTION 2.9: Knee Wall(s)

For improving the efficiency of aerated water circulation through the raceway cells, a knee wall is installed at the upper end of each cell between the CZ and the PZ. The function of this knee wall is to prevent water from flowing backward from the raceway into the WWU and thus ensuring that all water entering the head of the raceway originates from outside of the cell. This knee wall is the same thickness (25-30cm) as the raceway walls and generally formed from the same materials. It should be 60-80 cm tall (depending on water depth) and extend across the full 5-meter width of the raceway.

Two additional knee walls are also installed in the raceway cell. One at the downstream end of the cell, which is the far end of the QZ. It is constructed just as the upstream knee wall except it is only 30-40 cm tall. It functions to create a small eddy at this point in the raceway channel to prevent flow of waste solids from the QZ. This knee wall also is installed with slots to hold gates to prevent entry of filter-feeding fish from the open pond into the QZ. If fish are allowed access the QZ, they disrupt collection and removal of solids. A third knee wall 30 cm wide and 30-40 cm tall is also installed perpendicular to production zones across the center of the common QZ to create additional eddies and make it simpler to mechanically remove waste from the QZ.

## SECTION 2.10: Working Walkways (WW)

Working walkways are an essential element of the IPRS. These walkways allow access for feeding, managing and all activities on IPRS facilities. Walkways are installed on the upstream and downstream ends of each cell. They are typically a minimum of 1 meter wide, but they are often built 1.8-2.0 meters wide. They are typically formed to lay flat and extend across all raceway cell walls. They can be formed from steel, fiberglass, concrete or wood and should be strong enough to accommodate loads of feed, personnel, equipment and support minimally up to 500 kilograms.

Some walkways are strong enough for trucks while others on smaller installations are more modestly built. The upstream WW (working walkway) is best installed over the WWU so that it does not obstruct access to the upstream confinement gates or the PZ and is installed so that it allows maintenance and servicing of WWUs and confinement gates. The WW should be no closer than 30 cm from the upstream gate slot. The gates require occasional changing for larger or smaller mesh and for servicing so they should easily be accessible to workers. Likewise, the downstream WW should be constructed in a location with easy access to the downstream confinement gates. This will allow easy removal for cleaning or exchange to larger mesh sizes as fish grow larger.

**Figure 19A.** Upper end knee wall at WWU attachment point  
**19B.** Upper end knee wall at WWU attachment point  
**19C.** QZ knee wall separating two solids removal zones



**Figure 20A & B.** Working walkways for worker access and management  
**20C & D.** Working walkways in China and Vietnam



(photo credit: Thanh, Bui Ngoc)



## SECTION 2.11: Supplementary Aeration (SA)

Supplementary aeration is an additional feature and principle for IPRS operations. High-volume, low-pressure air is provided by a blower of the same type and model as is used for WWUs for IPRS. Slots are formed into the tops of the raceway walls to protect and support air delivery pipe (typically PVC), valves, fittings and aeration tubing. The photo below is an illustration of how the air is delivered to the aeration tubing. It is important to note that the slot only extends 15 meters down the wall top. This is because the supplementary aeration air system, when operating, has a negative effect on settling of solid waste in the QZ located immediately downstream. The additional 7 meters of raceway length is sufficient to allow solids settling in the QZ.

Air is delivered to the wall-top manifold pipe and through valves located every 1.5 meters down the length of the manifold pipe at the

top of each wall. In this arrangement, there are 10 drop tubes on each side of the raceway PZ, each ending in a “tee” fitting which supplies air to the Aerotube diffuser tubes that lie at the base of the cell wall. The diffuser tubes consist of a 1-meter length (actually two ½-meter lengths) of Aerotube supplied from the drop tube through the tee in the center. With the SA installation configured in this way there is a total of 20-meters of supplementary aeration in each raceway cell (10 on each side). The diffusers are set to remain parallel to the wall and do not extend into the interior of the raceway. Each diffuser tube of the supplementary aeration system is attached to a rebar or other type of weight to maintain its location at the bottom of the raceway wall.

Supplying supplementary aeration in the first 15 meters only it does not disrupt water flow and waste settling within the cell. This SA system is typically only operated continually when a raceway has reached 60% of the biomass target for a particular production cycle. However, it can be utilized whenever DO testing shows

the need, such as during periods of low photosynthesis (stormy, cloudy weather) and low pond DO and when fish health materials such as therapeutants are applied and water flow is fully interrupted. Additionally, for any species grown in temperate or tropical water, the SA may be utilized at any time when DO drops to a level of concern.

*Additional Notes on IPRS Equipment and Installation: Commercial application of the IPRS technology gains efficiency by placing multiple raceway units together in a parallel arrangement. Combining smaller ponds into a single larger volume unit makes it more cost-efficient to build and operate as an IPRS facility. Two ponds of 2.5 ha each can, for example, be made to function as one 5 ha pond where the IPRS installation can be composed of 5-7 cells, depending on volume, and gain an economy of scale with electrical controls, back-up systems and other gear deployed in one spot rather than two or more. Removal of part of the levee separating the two ponds can cause it to then function as a baffle wall or baffle levee.*

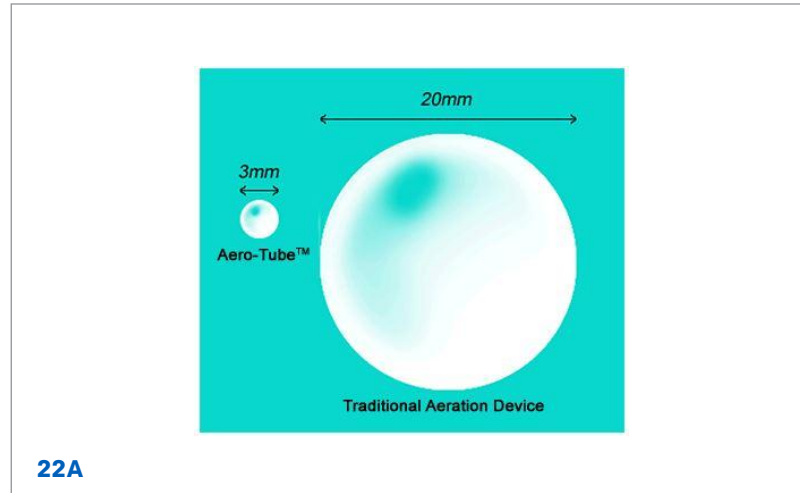
**Figure 21A – C.** Supplementary Aeration system in action



Materials for building IPRS cells are variable depending upon the country in which it is located. However, it is important to note for long term strength and efficacy, concrete, and similar robust materials, offer the longest life and utility. Various materials have been used to construct IPRS raceways, but they must provide the strength needed for operational success and longevity.

AeroTube diffuser tubing used in the WWUs has been thoroughly tested, and its performance parameters are known. This performance data is critical to the system design. The AeroTube diffuser was selected because its performance in trials provided the best balance between aeration efficiency in shallow water and volume of expanded bubbles to drive water flow through the raceway and around the pond. Diffuser tubes that look like AeroTube diffusers are for sale in the marketplace typically at lower prices. However, the performance of the diffuser copies seen so far have not exhibited similar high-performance characteristics seen with AeroTube. Utilizing the same equipment (brands and specifications) that have been tested and verified along with strict adherence to these guiding principles offer the greatest opportunity for success.

**Figure 22A – C.** Graphic of Colorite Tubing Performance



**22A**

### CONCLUSIONS from Testing Trials

- The observed clean water Standard Aeration Efficiency (SAE – Lb O<sub>2</sub>/Hr/HPwire) ranges from 4.0 to 8.0 Lb O<sub>2</sub>/Hr/HPwire, **decreasing with increasing air flow rate.**
- In all cases, the AeroTube™ diffusers provided more than two times the oxygen produced by the Paddle Wheel mechanical aerator.
- Increasing TDS (Salt) concentrations result in increased oxygen transfer.
- The AeroTube™ SAE increased from 5.0 in fresh water (0 mg/L TDS) to 13 Lb O<sub>2</sub>/Hr/HPwire in water with a TDS of 35,000 mg/L (~ sea water)
- The Paddle Wheel mechanical aerator SAE increased from 2.0 in fresh water (0 mg/L TDS) to 3.4 Lb O<sub>2</sub>/Hr/HPwire in water with a TDS of 35,000 mg/L (~ sea water)
- The AeroTube™ had a much greater increase in oxygen transfer with increasing TDS (Salt) concentration than that observed for the Paddle Wheel mechanical aerator.

**22B**

Technical Information 1" (O.D.) Aeration Tubing	
Outside Diameter	1.00 inch (2.54 cm)
Inside Diameter	.500 inch (1.27 cm)
Wall Thickness	.250 inch (0.635 cm)
Weight	.220 lbs per foot (0.327 kg per meter)
Roll Length	200 ft. (60.98 meters)
Roll Weight	44 lbs. (19.9 kg)
Burst Pressure	80 PSI (5.5 bar)

**22C**

## SECTION 2.12: Balancing Systems to Pond Volume

A critical element to understand in IPRS development and preparation is the number of IPRS units that may be built for a given pond volume. Pond volume is the primary design element dictating the appropriate number of IPRS units for a given pond.

Balancing can be achieved with the following calculation:  

$$\text{Pond volume (m}^3\text{)} / 10,000\text{m}^3 = \text{number of standard raceways to build (with } 220\text{m}^3 \text{ PZ)}$$

### Typical ratios are stated and illustrated below:

- 1 hectare with a 1-meter average depth (contains 10,000m<sup>3</sup>) will support one commercial size raceway with a production zone that

is 220m<sup>3</sup> (5m x 2m x 22m) and the efficient growth of 25,000-33,000 kg per cycle of the fed fish. These figures are species dependent, that is, some are more tolerant to IPRS conditions and density.

- 1 ha pond having a 2.0-meter average depth will support 2 standard IPRS units with dimensions of 5m x 30m x 2.3m; (previously stated as 5m x 22m x 2m growing volume (PZ))
- 2 ha pond with 2.0 m average depth will contain 40,000 cubic meters of water volume and will support 3-4 units (depending on actual pond volume) with dimensions of 5m x 30m x 2.3m; (previously stated as 5m x 22m x 2m growing volume- PZ)
- 10 ha pond with a 2.0 m average depth contains 200,000 cubic

meters and will support up to 20 commercial sized units with dimensions of 5m x 30m x 2.3 m

This ratio provides for optimum operational efficiency and reduced production risk. Each of the systems can incorporate stocker development cells to allow on-site stocker growth. This approach also helps the grower avoid unknowingly transferring diseases or parasites. Having access to stockers of a significant and appropriate size grown on-site is an extremely valuable asset in commercial IPRS production because these fish are difficult to find for purchase and expensive to buy and transport. The approach of producing stockers on-site can easily decrease the days per cycle and increase the number of cycles per year in both tropical and temperate environments.

**Figure 23.** IPRS Facility Planning Calculator: Shows number of IPRS raceways to build

Pond Size and Water Volume				
	Average Water Depth	Pond Width	Pond Length	Pond Volume
Pond A	2	100	100	20,000
Pond B	2.5	100	175	43,750
Your Pond Dimensions	2	100	200	40,000
OR Enter Pond Volume				60,000

Raceway Size and Production Zone (PZ) Growing Volume				
	PZ Water Depth	PZ Width	PZ Length	Growth Volume
	m	m	m	m <sup>3</sup>
Standard Raceway	2	5	22	220

Balancing IPRS Raceways with Pond Volume				
		Total PZ Growing Volume	Pond Length	Pond Volume
	Pond Volume	At 2.2% Pond Vol as Total Grow Vol	One cell per 2.2% pf Pond Vol	
	m <sup>3</sup>	m <sup>3</sup>	Number	Number
Pond A (Standard Raceways)	20,000	440	2.0	2.0
Pond B (Standard Raceways)	43,750	963	4.4	4.4
Your Pond	40,000	880	4.0	4.0
Known Pond Volume	60,000	1,320	6.0	6.0



## SECTION 2.13: Sizing Commercial Systems / Production Potential

The question of sizing systems in a pond is balanced against pond volume and NOT surface area. The volume of the pond is more critical to pond productivity if it is mixed, aerated and managed correctly because it is used to assimilate the waste load placed on the pond by the feeding the fish.

Current maximum achievable pond output from traditionally managed ponds approximates 6,000-10,000 kg/ha per year. Our research indicates (see Case Studies Section) that these systems managed correctly and in line with the defined principles can produce significantly more biomass than traditionally managed, intermittently aerated ponds. Using IPRS, annual yield per hectare exceeds 30,000 kilograms in temperate climates. IPRS operated in tropical climates can often double yields to 70,000-80,000 kg/ha per year.

Weight of fingerlings at stocking and stocking density determines the days required for fish to reach the final weight targeted per cycle. The density of animals stocked per cubic meter is determined by dividing the market target fish's weight into the 150 kg/m, the safe upper biomass limit (Section 4.2). If larger market size fish are desired, fewer are stocked per cell. Commercial size modules consist of three cells as described above. Larger ponds (greater volume) using more gear and multiple cells are more cost effective than fewer units. Recommended commercial scale cells are sized at 5m x 30m x 2.3m (wall height) (within this commercial cell, the PZ growing volume is 5m x 22m x 2m (water depth) or 220m<sup>3</sup>). This size cell achieves both cost efficiency per unit of system volume and commercial practicality.

## SECTION 2.14: The Baffle Wall (BW)

The baffle wall is an important feature in IPRS technology. While it is a simple structure, its function is important to the function of the IPRS pond. The BW acts to direct and guide the flow of water coming from the IPRS cells around the full length and width of the pond.

The BW and the WWUs installed on the raceway cells and in open pond locations function together to move, mix and aerate the whole pond allowing the biota of the pond to more rapidly assimilate the waste load placed on the pond. Earthen baffles can be formed using soil from the pond interior especially if multiple ponds are reconfigured to make one pond or a larger pond needs to be re-conditioned for the installation and operation of IPRS. The BW can also be formed from other materials like UV-protected HDPE. Non-earthen baffles must use material that extends from the pond bottom to 20-30 cm above the planned full pool pond water elevation. The BW typically extends from a point adjacent to the downstream most point of the QZ and farthest from the main levee.

The BW usually extends across the pond diagonally, but pond configuration will dictate its location. It is important to leave a gap between the end BW and the nearest levee that is at least 300% of the total width of the IPRS set-up in the pond. This may seem unnecessary, but failure to adhere to this principle can have a strong and negative effect on water flow and therefore, the rate of waste assimilation in the pond.

**Figure 24A.** Newly installed HDPE baffle walls **24B.** Newly installed heavy nylon fabric baffle wall





**Figure 25.** Earthen baffle levee (Mousa Wakileh)



## SECTION 2.15: Confinement Gates (CG) and Gate slots

Confinement gates and gate slots function to contain the fed species within the PZ of the raceway cell. Located at both ends of the production zone, that is the extreme upstream and downstream parts (head and tail ends) of PZ, the confinement gates not only retain the fish but must also facilitate water flow through the raceway system.

The purpose of the gate design is two-fold: a) to hold the smallest fish stocked in the raceway and b) optimize flow and water exchange through the cells. For these reasons, it is important to only stock uniformly sized (graded) fish and use the appropriate mesh or grill spacing to hold the fish. The materials used to build the gates are important. Metal, 304 stainless, fiberglass or similar strong but lightweight material forms the gate frame. The material that actually confine the fish is either PVC

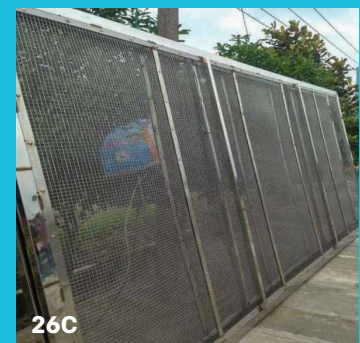
coated steel wire such as is used in marine crab or lobster traps or a 304 stainless-steel wire mesh. Because the materials are expensive, it is best to optimize the opening dimension and minimize the area occupied by confinement materials. Galvanized and similar mild steel or plastic mesh is not suitable and will fail quickly. Netting mesh (knotted) is likewise not recommended due to its rapid failure rate and abrasion on the fish.

Soft mesh may be used for a short period (3-5 days) when acclimating young stock to the raceway environment. The soft mesh reduces the incidence and significance of physical damage to fish which jump into the water flow coming through the gate only to meet the hard gate material. Soft mesh helps them adapt to the raceway without undue damage. Gates are used to confine fed species in the raceway and are used to exclude service or filter-feeding species from entering the QZ and creating problems with solids settling and removal. (See charts in Appendix for mesh openings to retain specific fish sizes.).

**Figure 26A & B.**  
Confinement gate slots



**Figure 26C & D.** Confinement gates ready to install



## SECTION 2.16: Electrical and Back-up Power Systems

Electrical systems include power supply and control systems for IPRS as well as the auto-start back-up system. Because IPRS is a flowing water technology, electrical energy is used to continually operate system equipment. Use of electricity around water requires qualified personnel to plan and install the necessary equipment for safe and reliable operations. Regenerative type blowers are used in the WWUs to maximize efficiency and minimize electricity costs. The recommended blowers are low horsepower (1.5-2.5 hp) and are available using either 50 or 60 Hertz electrical current. In some regions, motors are rated in kilowatts, which can be compared to horsepower using the formula: 1 hp [electric] = 0.746 kW.

Only sites where electricity is available and reliable are viable for IPRS, but appropriately sized and automatically starting back-up generation equipment is also essential. Qualified electricians are recommended for establishing the main electrical system as well as the auto-start back-up generator and associated switchgear. Because regenerative and other similar type blowers are known to have higher need for electrical current at start-up than during normal running or operation, electricians

typically employ timers to avoid simultaneously starting all blowers. Most use one- or two-minute delay timers between starting blowers. This inexpensive and reliable approach facilitates the use of smaller backup generators. The back-up generator is sized to only operate the WWUs attached to raceways and the supplementary aeration systems attached to them. Other electrically powered equipment not immediately critical to maintaining life support for fish need not necessarily be linked to the back-up generator. Nevertheless, when planning and installing electrical requirements for back-up generators, engineers recommend, and it is wise to plan for 2.5-3 times the actual expected need.

It is recommended that operating personnel practice power interruption procedures. It is advisable to schedule weekly operational drills to simulate power interruptions and similar failure modes. These activities require personnel to act quickly to address the problem including confirming that the auto-start generators turn on and supply the required loads. Often, electrical generators have a programmable exercise capability, but they do not automatically use its transfer switch to disconnect main line power and engage the on-site generator. Fully testing the system under the planned and realistic operational load on a weekly basis will provide a critical competency for personnel and assure generator operational readiness. Many operators and

owners use sensors and alarms to alert them when power interruption does occur even if they are off site. Mobile applications which enable alerts and alarms to be sent to multiple personnel are common and inexpensive today.

**Figure 27.** Alarm system installed on-farm to alert workers of power outage



**Figure 28A & B.** Auto-start back-up electricity generators



**Figure 29A – C.** Electrical control panels – professionally installed



## SECTION 2.17: Spare Equipment and Backup Systems

The IPRS technology is relatively new to most regions where it is being adopted. One of the principles for IPRS is to have critical equipment and spare parts on-site where IPRS is installed. Spare blowers, aeration tubing, pipe connectors, clamps, electrical wire and switches, fuses and so forth are kept in a secure room at the farm. Farm personnel need to be trained in procedures for correctly and efficiently replacing failed equipment when events require it.

## SECTION 2.18: Waste Management and Extraction

Production limitations and risk in all aquaculture ponds and especially high-performance aerated ponds is primarily due to water quality degradation caused by eutrophication from fish waste, feed particles and the other organisms (plankton, bacteria, and other biota) living and dying in the pond. Because fish are confined in IPRS raceways, we have the capability to collect and remove some of the settled solids from the pond system and greatly reduce the organic load that must be processed and assimilated by the pond due to intensive feeding. Because IPRS eliminates the exchange of “new” water to or from the pond, the pond biota must process the waste load. Removal of manure and other settled organic solids from the pond reduces the biological oxygen demand (BOD) and chemical

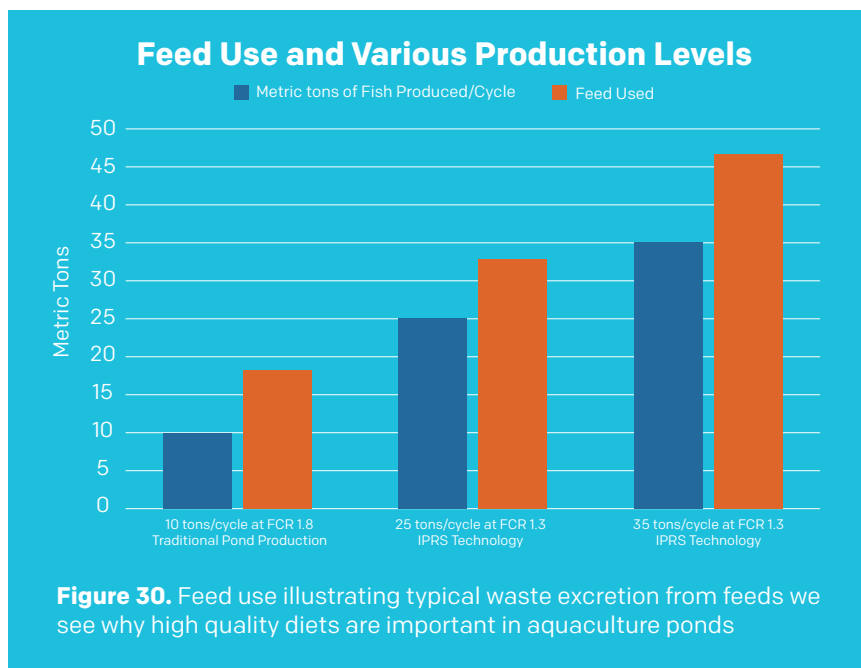
oxygen demand (COD) from the pond biota. Dissolved oxygen (DO) in the pond water produced through photosynthesis by phytoplankton or by aeration from WWUs provides for the needs of BOD and COD in the pond. The rate of nearly all waste assimilation processes in the pond are increased or reduced by the level of DO available to the biota (fish, phytoplankton, zooplankton, bacteria and other assimilation organisms). To increase the production capacity of the pond, we seek to increase availability of DO to accelerate and thereby, **reduce the BOD and COD in these ways:**

- Continuous aeration and mixing all waters of the pond
- Using filter-feeding or service species stocked in the pond to reduce loading via their consumption of organic material (biota- live or dead)
- Reducing the pond loading by removing as many settled organic solids as we can

## SECTION 2.19: Filter-feeding or Service Species

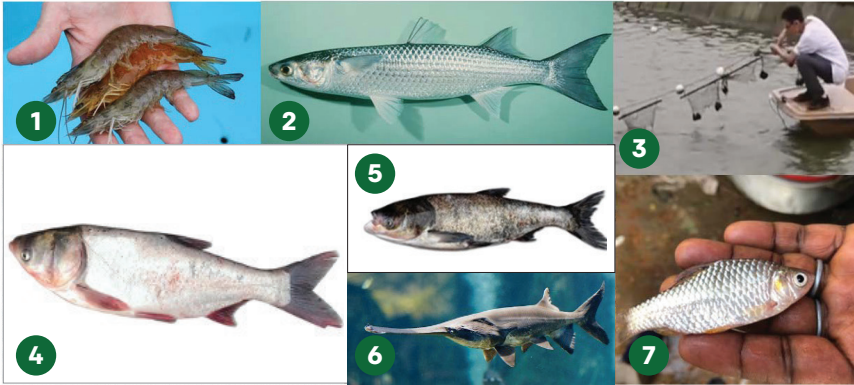
While we strive to have the fed species use feed efficiently with as high nutrient retention as possible and practical, all fish still excrete a great deal of waste from the feed they take in. Typically, they only retain 25-30% of the feed weight they consume. This means they excrete 70-75% of the feed weight they consume in three forms. Some of this is excreted in a gaseous form – like carbon dioxide, but the major portion is liquid (dissolved) and solid waste (manure) forms in about equal amounts.

As a principle of IPRS, we make all practical efforts to collect and remove the settleable manure solids and organic debris from the pond. The dissolved fraction, the liquid, is more difficult to collect. It is most effective with current technology to allow and encourage production of phytoplankton, zooplankton and bacteria in the pond to absorb and fix (assimilate) excreted nutrients available in the water column. To





**Figure 31.** Examples of un-fed service of filtering species stocked in open water – **1.** Shirmp **2.** Mullet **3.** Mollusck **4.** Silver Carp **5.** Bighead Carp **6.** Paddlefish **7.** Mola



capture these fixed nutrients, stock filter-feeding fish or service species to efficiently harvest these small planktonic forms. Tilapias, silver and bighead carps are good examples of this type of filter-feeding fish we can also sell in the marketplace. There are several other species of fish, bivalves (pearl clams), mollusks and crustaceans which are highly efficient in plankton, and detritus utilization. Operations that use filter-feeding fish can add annual biomass yield at 15-25% of the weight of the fed species with no added additional feeding. Operators are able to harvest and monetize additional fish weight while simultaneously improving the production environment by accelerating processing of an underutilized fraction of the feed investment now a portion of the waste load.

## SECTION 2.20: Solids Removal Equipment

IPRS technologies use specifically designed equipment to vacuum settled waste solids from the QZ floor and deposit it in onshore vessels for storage until it is removed from the site. While this can be done by hand, it is more efficient to utilize automatic, preprogrammed equipment to optimize waste reduction. **The gear used to vacuum up the solids within the QZ has developed in at least two forms:**

- 1.** A system using a submerged vacuum head drawn by a cable back and forth across the length of the QZ floor.
- 2.** A vacuum system or “car” suspended from and moving on a rail structure which allows it to travel the length of the QZ to vacuum and remove settled solids (See Section 4.13).

Both solids removal systems use a specific type of pump which is capable of pumping small diameter solids collected from the QZ. They are also referred to as solids-handling pumps or mud pumps.

These systems either pump a mixed slurry of water and solids into a slightly inclined, elevated trough affixed to the system which extends to and empties into the primary cell of onshore holding tanks or the system pumps the slurry via a long flexible pipe to the same type onshore solids storage vessel. The current designs for the 6-meter long QZ uses two segments of 3 meters each, separated by a low partition wall. Solids from each 3-meter segment are removed by independently programmed and operating systems.

The settled slurry is pumped 3-6 times daily from the QZ floor to the onshore storage vessels. This is somewhat variable depending upon feeding frequency, species and water temperature. The storage system consists of three vessels which pass water from the primary then into the secondary and last into the tertiary vessel. The nominal inside dimensions of the full-length system are 9m x 4m x 1.5m, which is sufficient length to allow settling for the primary, secondary, and tertiary segments.

**Figure 32A & B.** Two types of waste collection systems cables and rails



This size of storage vessel arrangement is sufficient for a 3-raceway or larger IPRS with more frequent removal of settled solids. On farms which have very limited space, the configuration of the waste storage vessels can be modified but should retain both the volume and number of vessels described above. For example, one farm uses three circular above ground tanks of 50-ton total water capacity that are fitted with a direct sludge removal gravity-fed design.

The function of these vessels is for short-term storage of the solid waste slurry. The primary vessel receives all new material and as it fills, most of the solids re-settle therein. As the primary vessel fills, the water, mostly free of solids, spills over into the secondary vessel. The secondary vessel allows further settling and as it fills, it eventually spills over into the tertiary vessel. Nearly all of the solids re-settle in the primary and secondary vessels but some small amount reaches the third vessel. Unlike the first two vessels, the third is vigorously aerated to provide gaseous exchange and the oxygen necessary for chemical reactions by bacteria and biota contained in the water to make, for example, any ammonia compounds pass from Ammonia (NH<sub>4</sub>) to Nitrite (NO<sub>2</sub>) to Nitrate (NO<sub>3</sub>).

Ammonia and nitrite are both highly toxic to fish at relatively low levels. But, even at sub-lethal levels, they also cause stress in fish and open the way for bacterial pathogens to attack and kill the fish. So, we seek to either remove the sources of carbon dioxide, ammonia and other toxic material from the water or assist pond biota in processing them to more benign forms that do not cause stress in the fish stocks.

Any water which may return to the pond should contain no waste materials toxic to fish. We recommend operators of IPRS plan for solid waste handling as much as they do for other IPRS operation principles. Solid waste slurry is heavy and will require heavy duty machinery for movement any real distance that is impractical for pumping through pipe or tubing. Some operators have developed a direct sludge removal where water above solids are decanted and remaining solids are fluidized and removed simply by gravity.

**Figure 33.** Example of solid waste collected



**Figure 34A & B.** Solids handling pumps



To accomplish emptying the solids slurry from storage vessels (primary and secondary), water is slowly and carefully decanted, that is, water free of solids is pumped from the vessels (primary and secondary) into the tertiary vessel until only the solids slurry remains. Then, a solids-handling or mud pump is employed to remove the remaining solids from the primary vessel. It is helpful to re-fluidize the slurry prior to pumping onto a tanker truck or similar equipment. The slurry materials have significant nutritional value as a directly applied fertilizer for sugar cane, lotus, coconuts, rice, forage grasses for cattle, and crops such as corn, wheat, and feed grains. The liquid water portion of the stored waste after it passes through the tertiary aerated vessel typically still contains a reasonably high level of nitrates. This nitrate laden water can be used to fertilize and provide water for nearby vegetable or fruit production systems or constructed wetlands. Remember, the flow rate for water through these types of plant arrangements is slow due to drag created by plant roots.

One approach to this is to use long, shallow water holding troughs of 20-30 meters length, by 1 meter wide and ½ meter deep. Nutrient rich water enters the end of the trough nearest the tertiary holding vessel and is allowed to pass slowly through it. Plants are cultured on floating rafts cut to fit the trough system. The trough water is aerated gently underneath the plant rafts to avoid development of bacterial colonies which can suffocate plant roots.



**Figure 35A & B.** Moving solids via hose and trough



A number of plants respond well to this system. Some have nutritional value, others absorb significant amounts of nutrients but offer little nutritional value. The water can be made to overflow a standpipe on the far end of the trough and return to the pond if the nutrients have largely been removed. If the IPRS facility is large and water volume entering the solids removal system is large, the dwell time for water in plant culture troughs may be too short for removal of all the nutrients. Thereby, additional troughs or a second battery of troughs might be added to be sure nutrients are removed.

**If the IPRS facility is large and water volume entering the solids removal system is large, the dwell time in 4-6 plant culture troughs may be too short for water in plant culture troughs may be too short for removal of all the nutrients. Additional larger-scale plant culture systems can be added on nearby levees or land or water can be pumped to adjacent agricultural applications.**

# SECTION

## **Installation and Commissioning of the System**

What you need to know before stocking with fish to ensure the IPRS are ready and prepared; an explanation of equipment used within and around the pond before or after filling the pond.

# 3

## SECTION 3.1: WhiteWater Units (WWU)

WhiteWater Units are airlift aeration devices that create a vertical and horizontal water flow. WWUs are placed on the raceways and in the pond to establish and maintain continual mixing, aeration and flow. Each raceway is equipped with one floating WWU. The operator can opt to make a connection between WWU's air lines, especially in temperate climates when water is cold. The water flow is started by the WWU through the raceway cells, emerges into the open pond and is directed by the baffle wall around the pond. The water flow is picked up by WWUs placed strategically in the open water to continue and enhance the flow around the pond, to re-enter the raceway cells.

The WWU placed in the open pond should be free-floating and level with the upper lip of the hood, extending 2-2.5 cm above water surface. Regular maintenance is required to retain this position in the water due to epiphytic attachments which increase the weight of the WWU.

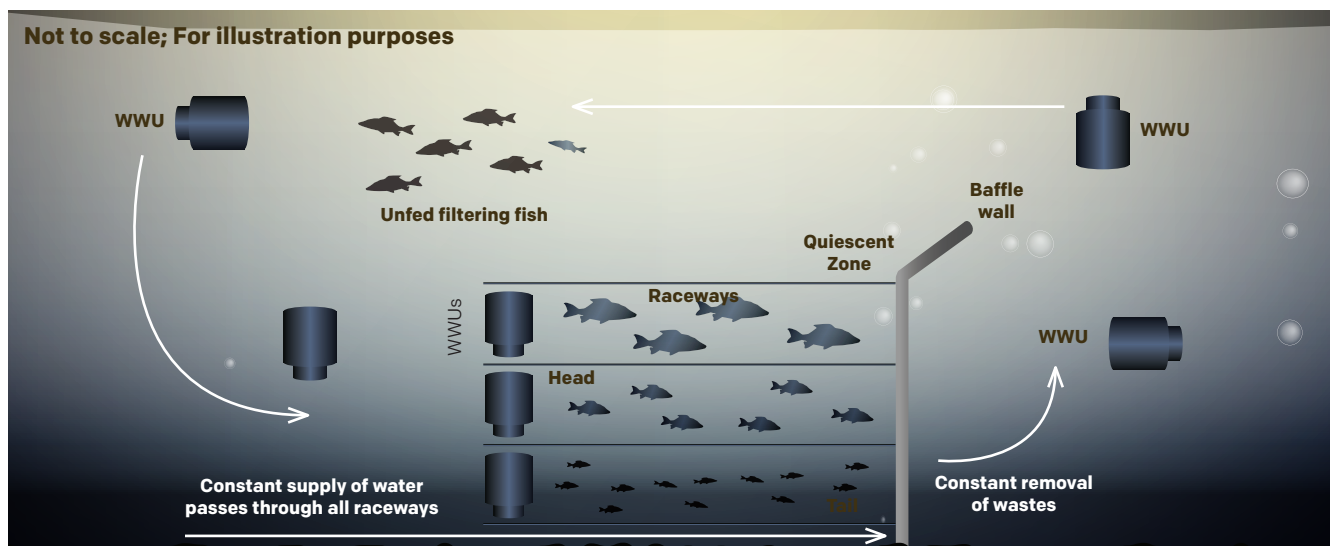
Position the unit lip 8-10 cm above the surface to accommodate this issue. The WWUs should be positioned over water between 1.5 and 2.5 meters deep. To enhance the flow from the WWU, it should be aimed slightly toward the nearest perimeter levee segment. The blower operating the WWU should be mounted on top of the unit. Air delivery tubing extends from the blower to the diffuser racks fixed underwater. Each blower unit holds a protective weather cover. It is important to have ready access to air filter canisters to facilitate periodic cleaning and maintenance.

Note that WWUs installed in the open pond with blowers mounted on top are top-heavy and can tend to turn upside down in the pond if they are not carefully detached from their mooring. Be careful to not allow the unit to turn over. It is, of course, a safe practice to turn off the WWU blower any time it is being serviced (air filters/canisters or diffuser tubing). Also, when mowing or cleaning levee slopes around or near WWU placement, avoid damage to the electrical power cords extending from the shore to the WWUs installed in the pond.

**Figures 36A – C.**  
Airlifts WhiteWater Units  
(WWUs) installed and  
operational



**Figure 37.** The sketch illustrates optimal placement of WWUs. Note the position of the baffle wall as a flow enhancement feature.





## SECTION 3.2: Confinement Gates

It is recommended for farms installing the IPRS to purchase or build several confinement gates with 2-3 mesh or opening sizes. Gates need to be standard sizes and interchangeable from one raceway cell to the next. Having gates readily available on hand with small, medium and large mesh openings allows for greater versatility in managing multiple species for culture and size fish that can be stocked. This is important as one of our IPRS principles is to **use a staggered size or date stocking strategy**.

**Figures 38A & B.** Confinement gates prepared and installed in Vietnam



## SECTION 3.3: Pond Bottom Preparations

Pond bottom preparation must be accomplished before filling the pond. If seasonally possible ponds are dried, leveled, tilled lightly and re-packed with a weighted roller. The bottom surface must be free of any living or dead vegetation. If there are living plants on the bottom, they should be killed 3-4 weeks prior to filling the pond. This way, the remaining dry plant residue can be easily burned or removed. In regions where pond soils are acidic, agricultural limestone is applied to the pond bottom at 4-6 tons per hectare based on soil analysis. This material is most often applied in powdered or small granular form to expedite its dissolving in the water.

**Figure 39A & B.** Applying agricultural limestone to prepare the pond ecosystem

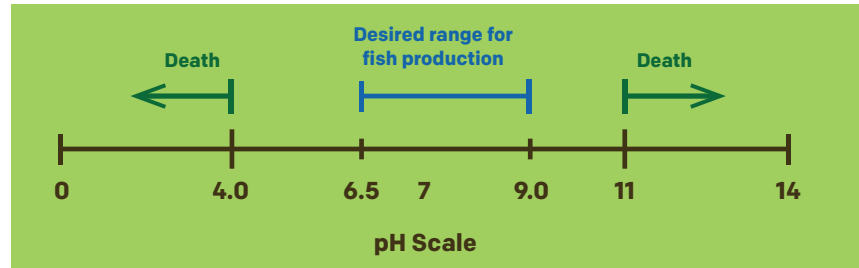


This application is spread evenly across the whole pond bottom. Typically, pulverized dolomite is used for this but calcite (calcitic limestone), another limestone form, may be more locally available and cheaper. Dolomite is the material of choice no matter the cost of the alternative. Hydrated lime or burnt lime forms are not recommended. Puddles are poisoned if they are not dried completely. No eggs, fry or small fish are allowed to become established as the pond is filled. As ponds are filled, care should be taken to exclude any wild fish or eggs that may be pumped into the system if a surface water source is used. Saran, or similar, strong but small mesh material should be employed to make this successful. Competitors of any kind, but especially wild or unwanted fish, are not welcome.

## SECTION 3.4: Knowing Water Chemistry (See Appendix A)

Just as it is important to know your soil in successful farming or gardening, the astute manager of IPRS needs to understand water chemistry. Numerous test kits are available and marketed world-wide for monitoring water chemistry in aquaculture ponds. Secure a good quality kit for analysis of your water. Beyond dissolved oxygen (DO) and temperature, parameters of high importance and worth recording regularly are alkalinity, hardness, salinity, ammonia, nitrite, carbon dioxide and pH. Alkalinity, hardness and salinity in the culture pond offer great understanding of pond chemistry. These parameters let the manager know what the system is capable of handling or producing and know the condition of the environment around the production system. For example, alkalinity is of great importance to know because it dictates so much within the pond environment. It is a measure of the mineral content (particularly calcium and magnesium carbonates) present in the pond water. Alkalinity plays a strong role in determining how fish can be handled, treated or how they react to and withstand stress and disease issues and even how well the waste load is assimilated.

**Figure 40A.** Example of desired pH range of water quality



A small investment in a water testing kit and the effort of learning to use it effectively allows production system situational awareness. (See Appendix A. Understanding Water Chemistry)

One of the most beneficial and inexpensive amendment materials used on commercial aqua-farms is agricultural limestone. Where soils or water are low in alkalinity, hardness or pH, pulverized limestone (dolomite or calcite) is broadcast evenly across the dry pond bottom just prior to filling the pond. The finely ground limestone is actual lime rock, but it is slowly dissolved by the pond water and its ions (calcium and magnesium carbonates) act to buffer the pond water. Ponds containing water with low levels of minerals (low alkalinity and hardness) might see pH fluctuations driven by photosynthesis range from 6.0 +/- in a morning reading to 10.5 +/- in the same pond in the afternoon. Conversely, similar ponds with adequate buffering from natural sources or amendments (alkalinity 50mg/l to 200 mg/l) might see shifts from 6.8 +/- to 8.4 +/- in pH.

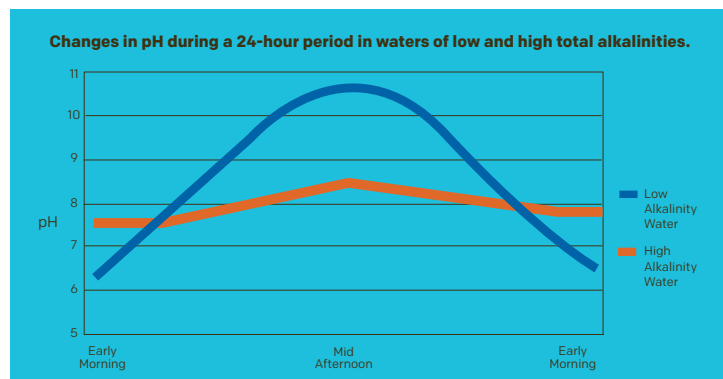
The pH scale is logarithmic so therefore, a shift of one pH point is significant; a shift of 3-5 full pH points can be highly stressful to fish and typically causes reductions in feeding responses and increases in disease incidence. Further, unionized ammonia, a fraction of TAN (Total Ammonia Nitrogen) is highly toxic to fish, and always a part of the ammonia present in pond water.

When pH readings swing above 7.0, the fraction of unionized ammonia expands with increasing pH. This unionized ammonia fraction then can become a silent killer of fish in all forms of pond aquaculture. All serious aquaculture farms need to know what their typical alkalinity levels are by actual monthly measurements across a full year because unless borehole (well) water is used, seasonal fluctuations in water chemistry are the norm. Borehole or well water used to fill ponds will bring its own chemistry, but, over time, pond bottom soils may greatly amend chemistry of source water originally measured.

**Figure 40B.** Inexpensive water quality test kit



**Figure 40C.** Changes in pH daily with high and low alkalinity





**Figure 41.** Saran sock filter for incoming water: Vietnam



## SECTION 3.5: No Water Exchange

It is asked frequently about the need for water exchange to and from IPRS ponds. **We do not recommend any water exchange from IPRS ponds other than to replace seepage or evaporative loss.** One farm uses a dedicated wastewater storage pond for receiving the treated wastewater effluent from the solids collecting system. Using this strategy, water from this pond can be recycled and used to supply other ponds (not IPRS) with water to replace seepage and evaporative loss.

Because the waste load associated with the production of fish is continually processed, it becomes much less desirable to exchange water from the pond into the natural environment. In many places, there is insufficient water available to do this, but in others, water is available nearby.

The quality of water outside the pond is already so deteriorated from other agricultural demands, it makes no practical sense to exchange water. A financially better and more environmentally sound approach is to manage the pond water with care and not be subject to bringing in unwanted competitor fish, pathogens and organic or inorganic materials from outside water sources. All surface water used for filling IPRS ponds should be filtered using a saran cloth mesh sock (or similar material) over the pump or water source discharge into the pond. Saran mesh should be small enough to exclude eggs, larvae or fry of fish or other competitors and the length of the sock sufficient to allow free flow of water. For large in-flows of water to fill ponds, a filtering mesh tube can be sewn with a rolled-over seam that can measure 15-20 meters in length. The more debris in the source water, the longer the filter mesh tube should be to allow for reduced cleaning frequency.

## SECTION 3.6: Establishing a Healthy Phytoplankton Bloom

Establishing a healthy phytoplankton bloom is of significant value before stocking and feeding fish in the IPRS. While some ponds and waters will develop phytoplankton blooms without much encouragement, others respond well to help. After clearing the emptied pond of any plant debris, poisoning puddles, and the application of limestone to the pond bottom, the pond is filled to full pool. When the pond is 75% filled, fertilizers known to stimulate a phytoplankton bloom are applied. A critical point: fertilization and establishment of the healthy biota needed for IPRS typically requires 3-4 weeks of sunny weather. Do not stock raceway cells or service species in the open pond until the phytoplankton bloom is well established. The bloom will help prevent the growth of bottom rooted plants and more importantly, will act to scavenge nutrients available in the water as a result of aggressive feeding. During this period of starting an IPRS pond, all of the other IPRS equipment should be operational during this time for resolving any system problems.

In most areas of the world where pond aquaculture is practiced, a fertilizer rich in phosphorus is key to quickly establishing a rich phytoplankton bloom. Fertilizers with typical known nitrogen, phosphorus and K- potassium (NPK) values are recommended below:

**Examples of fertilizers: N/P/K content and application rates:**

- **20/20/5 granular (100 kg/ha)**
- **10/34/0 liquid (10 liters/ha)**
- **10/52/4 water soluble powder (6-10 kg/ha)**

*Note: Even though phosphorus is typically most critical and abundant, a low level of nitrogen is also needed to establish a strong healthy bloom. In years past, pond operators used 0/55/0 (triple super-phosphate) to quickly establish blooms, but we know now that nitrogen is also necessary for more stable, healthy and balanced blooms. Bacterial abundance, especially nitrifying bacteria (nitrobacter and nitrosomonas), are stimulated to some degree by nitrogen from pond*

*fertilization. These bacteria play a major role in assimilation of waste nutrients and, most importantly, in changing ammonia to nitrite and nitrate. Both ammonia and nitrite at elevated concentrations are toxic to fish in culture. Aid these nitrifying and other bacteria by providing oxygen in abundance from pond photosynthesis and from aeration and mixing equipment (WWUs).*

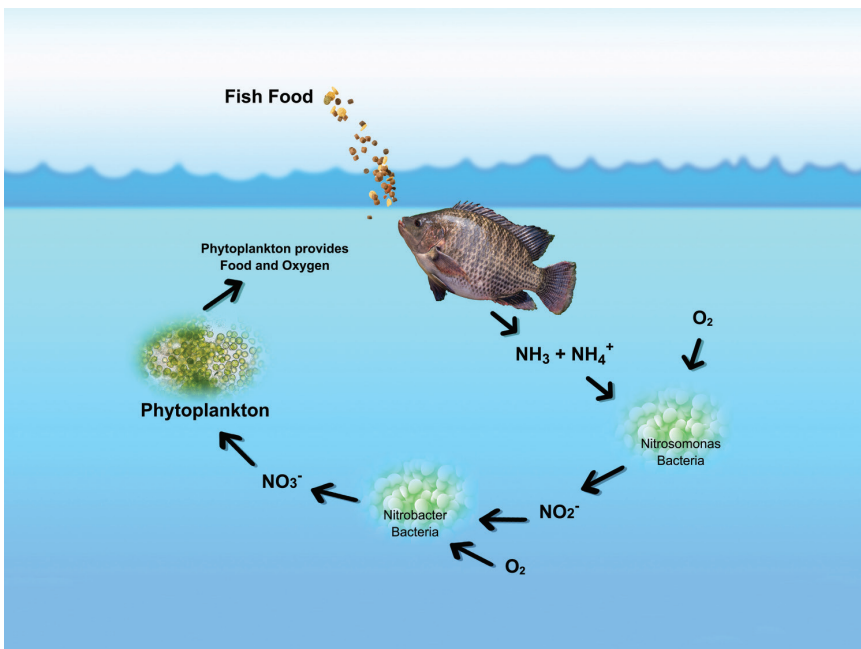
The WWUs role of mixing the water column is critical to IPRS success. The mixed water column, teeming with living organisms, is far more diverse and robust than the speciation found in traditionally managed ponds where water is primarily static. Static water blooms become quickly dominated by 1-3 plankton species and these will shade out competing species. Further, water near the pond bottom is seldom mixed and becomes anoxic. IPRS seeks to continually mix the pond water column from top to bottom and thereby, continually supply the needed dissolved oxygen to assimilation organisms from surface to the bottom. Once the bloom is established and feeding

IPRS has begun, it is unlikely the pond will need further applications of fertilizers. The bloom and all other biota including zooplankton, and bacterial biomass will be drawing nutrients directly and indirectly from nutrients excreted by the feeding fish. We want the density of these assimilation organisms to increase healthily as feed applications into the pond increase and nutrients are released by the feeding fish. Using continual mixing by operating WWUs allows achievement of this critical objective.

## SECTION 3.7: Water Velocity and Exchange Rate

Water velocity and exchange rate as it passes through the raceway cell should be approximately 7-10 cm/second. The equipment currently manufactured to USSEC specifications will achieve this exchange rate. Homemade or other equipment may not. A manager can check this flow rate without using expensive water flow testing equipment. Described here is a technique for determining water flow velocity through the raceway. The technique involves timing a free-floating indicator as it travels a known distance. In cells with 2 meters of water, cut 3-4 pieces of 2.5-3.0 cm PVC tubing to measure 1.8 meters long. Glue a cap on one end of each piece. Pour enough sand or gravel into the tubing to make the PVC stick stand vertically in the raceway but not touch the bottom and have only 4-6 cm emerging above the water surface.

**Figure 42.** Nitrification diagram with bacteria and chemistry



The tubes should float freely and vertically without touching bottom and with only their top showing. Once this balance is reached, you are ready to test the water flow rate. Now, cap the top of the tubes.

Turn off the supplementary air system for five minutes prior to velocity test. Using a watch or stopwatch, place the tubes in the upstream end of the raceway separately and gently and then start the time. Each tube moves with the water flow independently down the length of the raceway. Record the elapsed time for each once they reach the end.

**Formula for calculating water velocity: raceway length (cm) / seconds to travel raceway length = velocity (cm/sec)**

**Figure 44.** Photo of field application of checking water flow through raceways

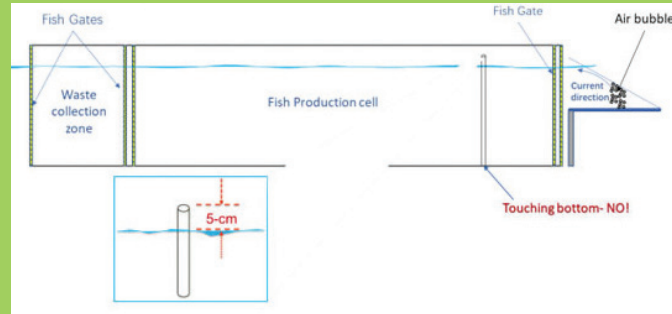


**Experience and Tips**

- Turn OFF bottom or supplemental aeration while WWU runs normally
- Place 3 test pipes simultaneously
- Deploy test pipes downstream from the upstream fish gate
- Place pipes 1 m away from side wall to mitigate turbulence effect
- Start the timer when all pipes are deployed in the water
  - Test pipes never go at a straight line. If the pipe gets stuck, repeat the measurement.
  - Travel speed varies. Average the results to get approximate current speed.

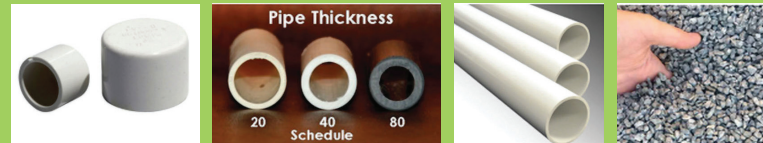
**Figure 43.** Illustration of water flow testing concept and actions: preparation of the water flow testing pipes

**PVC Pipe Length**



**Make the Tools**

- PVC pipe, 1 in, Schedule 20, White or Yellow (any bright color)
- Pipe length = Working Water Level + 5 cm
- Two Caps for Top and Bottom
- Gravel



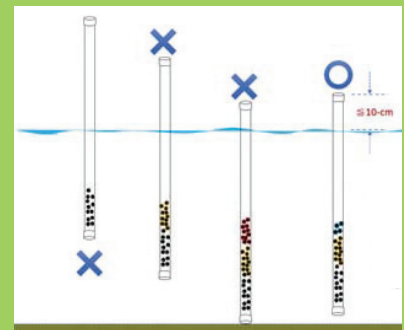
**PVC Pipe Preparation**

- Glue and cap the bottom
- Place proper quantity of gravel in the PVC pipe until it almost reaches neutral buoyancy = pipe floats vertically and almost touches the bottom
- Glue and cap the top after correct buoyancy found

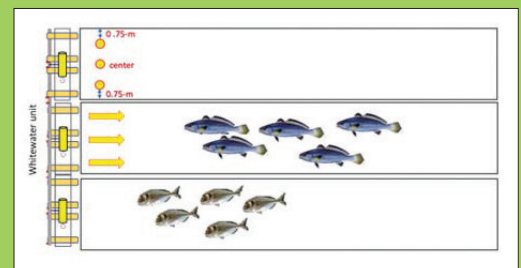


**Proper Quantity of Gravel**

- Adding gravel into pipe until the pipe touches the bottom
- Remove some gravel out of the pipe until the pipe slightly floats
- Adjust the gravel until free board on tube is ≤ 10 cm
- Close the pipe top cap, ready for the test



**Time Check and Deployment (Floating IPRS)**





**Figure 45A.** IPRS Planning Tool: Water velocity and exchange rate calculator (Kemp)

### RACEWAY WATER VELOCITY AND EXCHANGE RATE CALCULATOR

**Directions:** Enter user data into the orange boxes to determine velocity of water flow and hourly raceway volume exchange rate

**Targets:**

- A. 8–10 cm/sec water velocity
- B. 10 complete water volume exchanges per hour

Raceway Cell	Average Time		Raceway Length		Water Flow Velocity	Volume Exchanges per Hour
	minutes	seconds	meters	cm	cm/sec	per hour
Example	4.0	240.0	22	2200	9.2	15.0
Example	8.5	510.0	22	2200	4.3	7.1
Your raceway 1		0.0		0		
Your raceway 2		0.0		0		

**EXAMPLES:**

The standard 22-meter Production Zone (PZ) is 2200 cm in length, so, simply divide 2200 cm by the total number of seconds each tube requires to reach the downstream gate. As an example, tube A takes 4 minutes and 7 seconds or 247 seconds; then 2200 cm/247 seconds = 8.9 cm/sec. Then, tube B takes 4 minutes and 31 seconds or 271 seconds; then 2200 cm/271 seconds = 8.1 cm/sec. Finally, tube

C takes only 4 minutes and 25 seconds to reach the downstream gate. So, 2200 cm/265 seconds = 8.3 cm/sec is the speed of tube C. Then, we calculate the average speed  $(8.9 + 8.1 + 8.3 / 3 = 8.43 \text{ cm/second})$  at 8.43 cm/second. That velocity and up to 10 cm/sec is typical of IPRS facilities as they are started, but with subsequent growth of fish and biofouling of mesh gates and diffuser grids the velocity will often become slower. This flow rate is not excessive or overly challenging

for fingerlings or stockers typically stocked into raceway cells. This simple IPRS principle to gauge WWU performance, is conducted periodically to test and evaluate WWU performance and water exchange rate for each cell. Conduct this test during your 3-4-week start-up period before stocking the raceways to record a baseline flow rate. This is valuable information for the IPRS manager as he becomes skilled as an operator.

**Figure 46.** Water velocity testing



## SECTION 3.8: Establishing Backup Electricity Generator

The auto-start electrical power generator of the correct size must be installed correctly, or it will not likely perform as you require. Backup systems are expensive, but if you plan to forego the generator, we recommend you postpone your investment in IPRS until you are willing to purchase and install the appropriate gear. Skilled electricians should be engaged to install this system as well as all electrical system elements. IPRS facilities require electrical systems which operate continually, 24 hours a day and 7 days a week. Continual duty wiring, switches, connectors, fuses, and associated gear and materials are critical to operational reliability and safety. Use of electricity around water is commonplace, but for IPRS, it is critical to the soundness of your investment, fish health and safety of workers. Safety around IPRS will be discussed in a later segment but SAFETY of workers is a strong principle for managing and operating IPRS.

The stand-by electrical generator is one of the most critical pieces of equipment for IPRS installations. This is a type of insurance policy bought for the farm. It is critical to operate this machine under load weekly. It is useful to conduct a weekly test to be sure personnel fully understand how to correctly respond to an interruption of electrical power and that the backup generator system starts and operates correctly under full load. The person or persons who are responsible for being sure the generator starts and runs to produce electricity need to be thoroughly trained to troubleshoot operation and maintenance of this generator. Over time, electrical switchgear and associated cabinetry need to be cleaned and free of spider webs, insect nests, dust and debris. Further, the manager needs to be sure any necessary fuses or similar spare parts are present and available for use. It cannot be stressed enough that it is important to provide training for on-site managers or workers responsible for being sure the generator will start and run to safely provide appropriate electrical current.

For more information  
about IPRS, contact  
[IPRS@ussec.org](mailto:IPRS@ussec.org).

**Figure 47A & B.** Auto-start generators should be diesel, LNG, CNG or LP fueled



# SECTION

## **Management of In-Pond Raceway Systems**

In-Pond Raceway Systems are a principle driven technology which allows 200-300% greater production of fish compared to traditional management. This section provides many of the principles managers need to follow.

# 4



## SECTION 4.1: Culture Techniques, Operation and Maintenance

This portion of the IPRS manual deals with key elements and approaches for optimizing productivity and profitability and must be applied by managers wanting to optimize the performance of IPRS facilities.

## SECTION 4.2: Stocking Approach

For successful and smooth operation, only healthy, uniformly sized fish are stocked in IPRS cells. In planning for stocking, managers should make commitments for fingerlings well in advance of stocking because IPRS requires greater numbers and often uses larger sizes of fingerlings than

traditionally managed operations. Large fingerling fish, called “stockers”, should be stocked in IPRS raceways. These stockers are typically larger than the fingerlings stocked in traditionally managed ponds. The justification is that large stockers reach the desired market size faster and with more size uniformity than smaller fingerlings. But, they are more expensive and more difficult to handle without damage. Many IPRS operators purchase small, graded fingerlings which are cultured to the desired stocker weight at their farm. This way, the fish are cheaper to purchase, available when needed and already acclimated to the raceway environment. If larger stockers are developed and used, often in intemperate climates fish can reach market weight in a single growing season. In tropical settings, and depending on species and market target weight, 2-4 cycles

per year are possible and routine. So, when planning IPRS operations, carefully consider your target market size and desired time of harvest.

**Three planning decisions are needed to determine the raceway stocking rate (fish/production unit):**

1. Target biomass (kg/m<sup>3</sup>)
2. Target harvest size of fish (kg)
3. Total volume of production unit (m<sup>3</sup>)

Use the following guide for determining stock density. Managers of new IPRS farms should target more conservative densities and increase them with experience.

**Maximum stocking density is calculated by:**

Maximum biomass per raceway cell:

- Production Raceway volume (220 m<sup>3</sup>)
- Grow-out: 120-150kg/m<sup>3</sup>
- Stocker production (from fingerlings): 100-125kg/m<sup>3</sup>

**Figure 48.** IPRS planning tool and calculator for the number of fish to stock in raceways (Kemp)

### FINGERLING AND STOCKER CALCULATOR

This calculator determines the number of fish to stock into raceway cells (with PZ = 220 m<sup>3</sup>)

**Directions:** Enter user data into the orange boxes.

**Assumptions:**

1. IPRS is built, sized and operated according to BMP guidelines
2. Fish growth to market depends on stocker size, water quality and feeds
3. Feed is USSEC recommended diets for the species and sizes

Examples	Species	Location	Target Max. Biomass Density	Target Harvest Size	Volume of Raceway PZ	Est. Survival	Number of Fish to stock
Raceway cell			Kg/m <sup>3</sup>	Kg	m <sup>3</sup>	%	
Growout	Grass Carp	China	150	2.2	220	90%	16,667
Stocker development	Grass Carp	Vietnam	100	0.300	220	90%	81,481
Growout	Tilapia	Egypt	60	0.500	220	90%	29,333
Stocker development	Tilapia	Thailand	75	0.060	220	90%	305,556
Other							
Other							
Other							
Other							

- Optimal production ranges are species dependent

Stocking rate (fish/cell) = (Target biomass x Volume of PZ) ÷ Target harvest size of fish

**Examples: Produce Food Fish:**

- A.** To produce 1.5-kilogram fish:
- Target raceway (PZ) biomass (kg/m<sup>3</sup>): 150 kg/m<sup>3</sup>
  - Target harvest size of fish (kg): 1.5 kg
  - Total volume of raceway production unit (m<sup>3</sup>): 220 m<sup>3</sup>
  - Stocking rate= (150 kg/m<sup>3</sup> x 220 m<sup>3</sup>) ÷ 1.5 kg/fish = 22,000 fish/ raceway cell
- B.** To produce 500-gram Tilapia:
- Target PZ biomass (kg/m<sup>3</sup>): 125 kg/m<sup>3</sup>
  - Target harvest size of Tilapia (kg): 0.5 kg
  - Total volume of PZ (m<sup>3</sup>): 220 m<sup>3</sup>
  - Stocking rate = (150 kg/m<sup>3</sup> x 220 m<sup>3</sup>)/0.5 kg = 66,000 fingerlings/cell

**Examples: Produce Stockers from Fingerlings:**

For stocker development, use a target biomass of 125kg/m<sup>3</sup> (less than for grow-out fish)

- A. To produce 100-gram stockers:**
- Target raceway biomass (kg/ m<sup>3</sup>): 125 kg/m<sup>3</sup>
  - Target harvest size of fish (kg): 0.1 kg
  - Total volume of raceway production unit (m<sup>3</sup>): 220 m<sup>3</sup>
  - Stocking rate=(125 kg/m<sup>3</sup> x 220 m<sup>3</sup>) / 0.1 kg/fish = 275,000 fish/raceway cell
- B. To produce 800-gram stockers:**
- Target raceway biomass (kg/m<sup>3</sup>): 125 kg/m<sup>3</sup>
  - Target harvest size of fish (kg): 0.8 kg
  - Total volume of raceway production unit (m<sup>3</sup>): 220 m<sup>3</sup>
  - Stocking rate= (125 kg/m<sup>3</sup> x 220 m<sup>3</sup>) / 0.8 kg/fish = 34,375 fish/raceway cell

*Note: Exceeding these stocking numbers or USSEC-derived principles for reliable and safe production may cause the IPRS performance to deviate from output outlined.*

## SECTION 4.3: Stock Selection and Grading

The IPRS uses a strategy where the fed species are grown in confinement. Like other livestock such as broilers, swine and cattle, it is important to group similar sized and genotype fish together for optimal efficiency in production. It is important to stock healthy, genetically selected fish stocks that are very similar in size. Stocking non-uniformly sized fish into a grow-out system will result in a wider range of sizes at harvest, whereas stocking uniformly-sized large stocker fish results in a larger percentage of the crop being the desired market size all at the same time. Irregularly sized fingerlings or stockers are a factor that diminishes feed efficiency in the grow-out phase as well as size uniformity at harvest.

**Figure 50A & B .** Fingerlings can be stocked in small or large batches



**Figure 49.** Stocking uniform fingers, treated with potassium permanganate during transport



## SECTION 4.4: Staggered Stocking

To optimize annual yield, efficiency and minimize risk, use a staggered approach to stocking sizes and/or dates. A separation of 1-3 months between projected harvest dates for fish in different raceways reduces the daily feed ration and resulting nutrient assimilation burden on the pond. This practice mitigates risk, spreads cash flow and market entry. If a staggered stocking regime is not used and all fish are expected to be harvested about the same time, the pond will be significantly over-fed and water quality will not allow highly efficient FCR expected following IPRS principles. For example, if an operator is feeding three cells with similar sized fish, as they approach 30 tons per cell, daily feed allocations will be approximately 750 kg/raceway cell or 2250 kg in 30,000 cubic meters of water. This approach will lead to a deterioration in water quality leading to high mortality rates, inefficient FCR and loss of any possibility for a positive return on investment (ROI). Proper advanced planning will allow farmers to produce 1-4 cycles per year depending on climate, stocking weight and market size/weight target. Farmers managing multiple

IPRS cells in a staggered approach recognize this to be a valuable management strategy allowing better system efficiency, market planning and ROI.

## SECTION 4.5: Management of Filter-feeding and Service Species

The principle for production of filter-feeding species in the open pond of IPRS ponds is a strategy developed, promoted by USSEC and demonstrated over many years in China. It was described more recently by USSEC demonstration projects in the U.S. Hanson, et.al. It is called the "80:20" principle and is used extensively in ponds and lakes where fish were fed to market size in cages or pens. This principle states that 80% of the total annual crop can be derived from fed species contained in the raceways and 20% of the total annual crop can be derived from unfed service species grown without additional feed in the open pond.

Service species include a group of fish called filter-feeders because their food is in the form of phytoplankton and zooplankton

filtered from the water by their gill rakers. Service species also include other non-filter-feeding species that feed on natural food, benthos and organic detritus. Service species are never fed a pelleted diet, thus the term "unfed".

Service species function as pond cleaners and assimilation organisms which are beneficial to the IPRS pond environment. Using such species in the correct density and ways, the manager can likely harvest 20% of the fed species biomass in the form of these filter-feeding fish. Service species include tilapia, silver and bighead carps, black carp, mud carp and the filter-feeding Indian carp species. Other service species that have been used include bivalves in lantern nets for production of freshwater pearl nacre for jewelry and crustaceans such as shrimp (*L. vannamei*) and river crab. There is a cost involved with stocking the juveniles, but, but the return typically offsets the investment in fingerlings and harvest costs. Service species indirectly and directly harvest the waste stream released by the fed species and process it to reduce its negative impact on the pond water quality. Further, marketable size fish in this group can be selectively harvested and sold at intervals to add significantly to the annual ROI on the IPRS.

As with stocking fed species in raceway cells, it is important to stock filter-feeding species fish to spread out the time necessary to reach peak biomass or harvest targets.

**Figure 51.**

Illustrates results of not following the operational principles for IPRS. The operator installed too many raceways in the volume of water available and caused a large loss of fish and capital





**This is achieved by:**

- Stocking at intervals or by stocking different sizes or species for servicing the pond
- Partially harvesting market size fish to maintain the optimal biomass at safe level
- IPRS principles dictate that there is NO FEEDING of service species in the IPRS pond.

Sample monthly to determine when service species are close to market size and weight. Typically, filter-feeding species can be easily trapped, netted and sampled near the outflow of raceways, especially during or immediately after feeding fish in the raceways. Restock fingerlings of the harvested service species as soon as practicable after harvest to smoothly maintain their ecological servicing functions. See Figure 31 on p. 30.

## SECTION 4.6: Feeds and Feeding

Using systems designed and built to optimize profitability, modern managers of aquaculture businesses realize all forms of aquaculture are a means of adding value to feed grains. Similar to the production of broilers or swine, investments in aquaculture feed inputs dominate the focus of the aquaculture business. To efficiently optimize the return on the investment in feeds, electricity, seed stock and labor, seek to make sound investments in those inputs to get the most from the investment. To achieve this, managers purchase reliable seed stock, aeration equipment, competent labor and top-quality feeds. Typically, high quality nutritionally

**Figure 52A – C.** Feeding fish in IPRS by hand and with programmable feeders



complete and balanced feed comprises at least 55-65% of the production cost for growing market-ready fish, so choose the best performing diet available. Experienced managers know that low-cost incomplete diets containing less expensive ingredients generally do not perform efficiently in traditionally operated ponds and significantly less so in intensive systems such as IPRS.

Feed must supply 100% of the protein, fat, energy, vitamin, mineral and other dietary requirements of fish cultured in IPRS raceways. It is important to feed IPRS fish with nutritionally complete and balanced diets which contain better quality ingredients. Soybean meal has already become an independent and cost effective feed ingredient in fish diets because of its excellent composition including high protein content, high digestibility, relatively balanced amino acid composition, reasonable price and stable supply etc.

Consider the amount of feed required to produce 8000 kilograms of fish comparing two diets similarly priced, but with differing feed

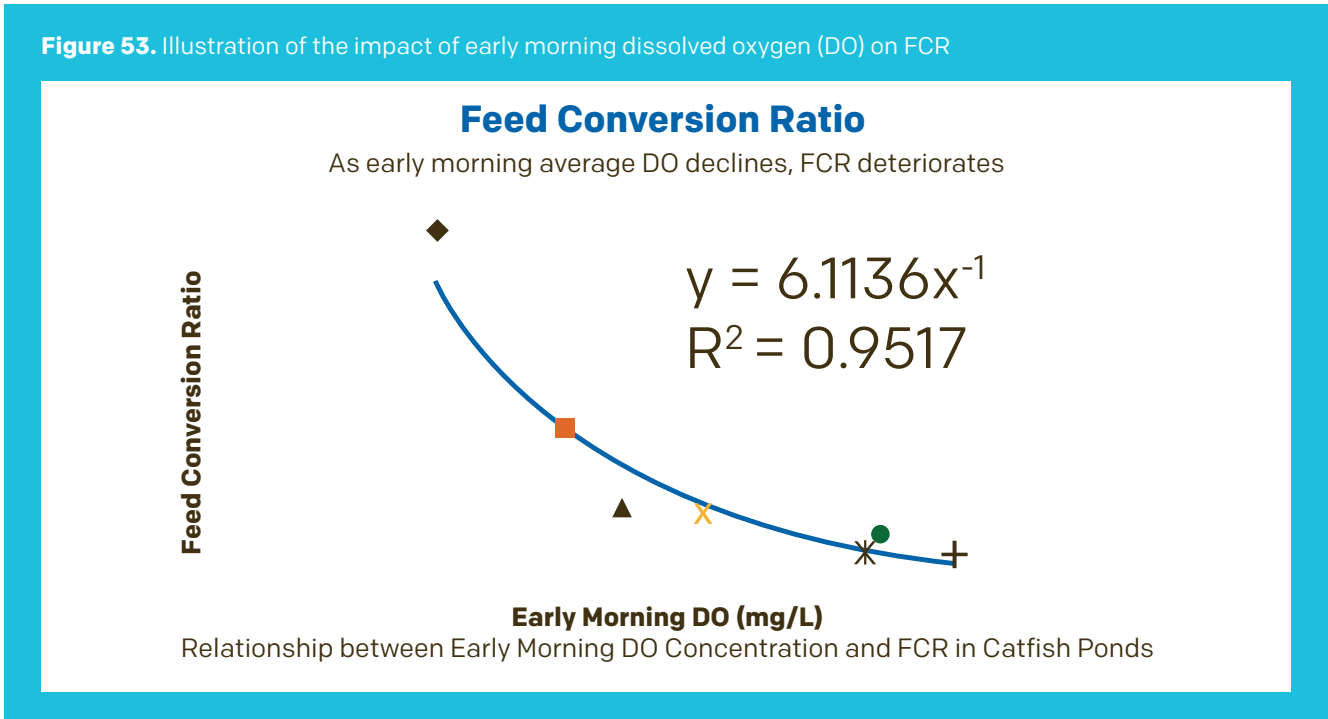
conversion ratios (FCRs). One diet turns out a routine 2.2:1.0 FCR and the other a more attractive 1.4:1.0 FCR. The better performing diet uses about 3 tons less feed to produce the same weight of fish. **Diet quality matters greatly if profit margin (ROI) is the main objective.**

The opportunity for better feed efficiency by growing fish in IPRS justifies its application in modern aquaculture. **Feeding efficiency in IPRS is better than traditional pond culture because:**

- A.** Feeding known inventory
- B.** Feeding groups of very similar sized fish
- C.** Feeding behavior is easily observed
- D.** Feeding occurs in a higher water environment quality
- E.** Multiple daily feedings are feasible with automation for better FCR and economy

Feeding in IPRS facilities lends itself

**Figure 53.** Illustration of the impact of early morning dissolved oxygen (DO) on FCR



to feasibly use automated (pre-programmed) feeding and remotely operated feeding equipment. Feeding fish by hand takes time when done correctly and most managers enjoy watching their fish feed.

However, using programmable feeders can save time and labor especially when used on larger IPRS farms. A combination of hand and machine feeding may be the best strategy to achieve optimal feed efficiency and nutrient retention in IPRS.

Trials conducted with multiple species and in varying environments have produced high feed efficiency results (FCR = 1.1-1.5:1.0) (See Case Studies for results of

these trials) with high survival rates.

No usage of feed supplements or agricultural by-products are required in IPRS feeds.

Most of these products offer little nutrient value compared to high quality diets. Agricultural by-products are not a part of modern aquaculture because they are known for poor FCRs resulting in the decline of pond water quality.

See Appendix K for high-quality feed

recipes commonly used in production of several different species cultured in IPRS and fed soy-based complete and balanced diets.

**Soy-based products as ingredient for fish feeds:** Because fish meal and fish oil are becoming limited in supply, increasingly expensive and are not sustainable feed ingredients, a lot of effort has been made to find protein replacements for use in fish feeds. Fish feed recipes with inclusion rates for soy-based ingredients appear in Appendix J.

**For more information about IPRS, contact [IPRS@ussec.org](mailto:IPRS@ussec.org).**

## SECTION 4.7: Feeding Practices: Ninety Percent Satiation Feeding

The feeding environment in IPRS is stable and typically of nearly optimal quality owing to the IPRS principles and continuous WWU operation. Therefore, feed offerings and the response of fish to the feed is also stable and generally predictable. The ninety percent satiation feeding approach (90% satiation), promoted by USSEC globally, has been used successfully in the culture of multiple species in IPRS.

This method of 90% satiation feeding is described in commercial fish feeding practices literature (Lovell, T, 1989). Traditional open pond feeding regimens are based on feeding a percentage of the total fish biomass daily (% BWD). Daily rations are periodically adjusted based on water temperatures, fish life stage and sampling for average size/weight.

The 90% satiation regimen differs from traditional feeding regimens in that the fish are periodically hand-fed to "satiation" meaning they are fed all they will consume in a given time period. Managers schedule satiation feeding events every 7-10 days depending on size

of fish and water temperature. The satiation feeding event occurs over a 20-30 minute period of time or until the fish cease actively feeding. The total amount of feed consumed during the satiation event is recorded and fed for the next 7-10 days. Some growers expand this to a 2-week interval and also include sampling as an additional aspect of determining feed application rates. However, no matter which of these elements is used, the fish will determine how much they will eat. The skill and understanding of 90% satiation for application of feed must be fully applied by the personnel or programmable feeder actually doing the feeding.

**Figure 54.** Calculator for optimizing feed efficiency using 90% satiation strategy

### FEEDING CALCULATOR BASED ON 90% SATIATION

This calculator determines the number of fish to stock into raceway cells (with PZ = 220 m<sup>3</sup>).

#### Directions:

1. Conduct the satiation feeding event every 7-10 days. More often for small fish, less often for larger fish.
2. Feed fish all they will consume in 20 minutes for 2 times one day and record this amount.
3. Stop feeding if feed reaches the QZ to prevent wastage.
4. Divide daily feed ration into multiple feedings each day to further improve FCR.
5. Enter daily feed rations and feeding notes into farm records daily.
6. Refrain from dumping the entire ration into one spot, but distribute evenly over the schooling fish.
7. Stop feeding and investigate if activity is slow or reduced, this may indicate water quality or other concerns.

Raceway cell	Weight of Feed to Satiation	Daily Feed Ration				Approximate Satiation Level
		Number of Feedings				
		1	2	3	4	percent
	Kg	Kg	Kg	Kg	Kg	%
Satiation Example Day 1	200	200	100	67	50	100
Day 2		200	100	67	50	98
Day 3		200	100	67	50	95
Day 4		200	100	67	50	92
Day 5		200	100	67	50	89
Day 6		200	100	67	50	85
Day 7		200	100	67	50	80
Day 8	210	210	105	70	53	100
Enter your Day 1	45		23	15	11	100
Days 2-7	45	45	23	15	11	98-80
Enter your Day 8	50	50	25	17	13	100
Days 9-14	50	50	25	17	13	98-80



**Figure 55.** Calculator tool for feeding a percent of body weight daily (BWD) or total crop biomass

**Directions:** Use this calculator for the daily feed ration based on a percentage of the estimated body weight (or total crop biomass).

Feeding Calculator based on Percent Total Biomass Daily (or Percent Body Weight Daily %BWD)										
Pond/ Raceway Cell	Fish Species	Location	Number of Fish Stocked	Est. Survival	Estimated Avg. Weight Each	Total biomass (body weight)	Daily Feed Ration			
							Percent of Total Biomass (or Body Weight)			
							2%	3%	4%	5%
				%	Kg	Kg	Kg	Kg	Kg	Kg
Example 1	Grass Carp	China	25,000	95%	0.25	5,938	119	178	238	297
Example 2	Tilapia	Egypt	12,000	95%	0.09	1,026	21	31	41	51
A	abc	pqr	10,000	95%	1.00	9,500	190	285	380	475
B	def	mno	20,000	98%	0.50	9,800	196	294	392	490
C	ghi	jkl	30,000	90%	0.25	6,750	135	203	270	338

*Note: To feed BWD percentages greater than 5% add two columns. For example, to feed 7% BWD add the 4% ration and the 3% ration.*

**Figure 56.** Feeding calculator tool for maximum feed burden on pond

Total Feed Burden for Ponds Calculator			
Pond/Raceway Cell	Total Surface Area of the Pond	Total Weight of all Raceways Daily Feed Rations	Total Feed Weight per Pond Area
	Ha	Kg	Kg/Ha
Example 1	1	200	200
Example 2	5	2000	400
A	2.25	350	156
B	3.00	450	150
C	4.00	800	200

The daily ration can further be divided into multiple feedings, which improves FCR.

Using this regimen, after 10 days fish are likely getting 80-83% of satiation. So, on average, the fish are getting about 90% of satiation for the period. This requires some experience to execute accurately and should reflect the new biomass of fish after the period of growth just prior to the satiation event.

The goal of feeding is to optimize the investment made in feed to efficiently grow fish biomass for marketing at a profit. Using high quality complete feeds and an efficient feeding strategy can allow feed efficiency to market sizes of 1.4:1.0. It is not unusual to see feed efficiency figures for small fish and stockers of 0.85 or 0.95: 1 because their nutrient retention is very high. These figures are species dependent. Poor quality feed and poor feeding practices increase input costs in commercial aquaculture.

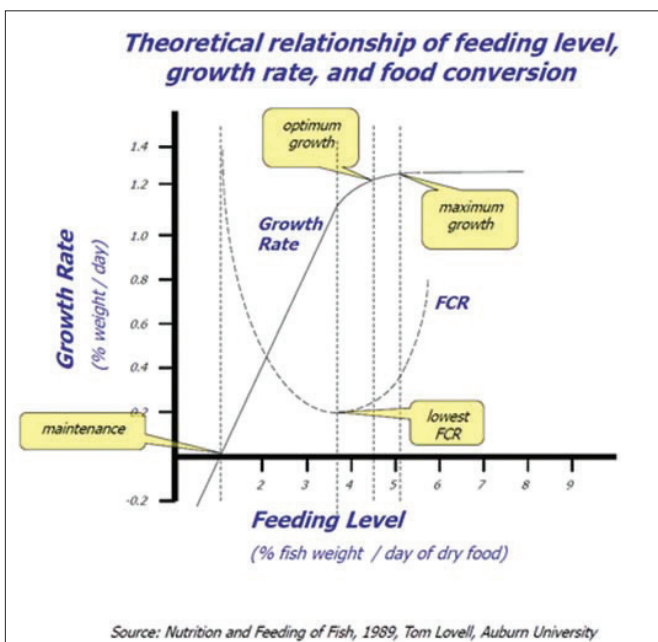
IPRS is ideal for mechanical feeding systems. Some of these feeders can be programmed to offer a set amount of feed ration on a regular schedule, others may offer a dribble of feed almost continually. These feeders should also be set up to achieve optimal feed efficiency and growth by using the 90% satiation schedule. The graphic illustration below helps one understand the relationships of feeding and growth. See Appendix J. for more on how FCR and water quality are strongly correlated. The higher the early morning DO the lower FCR can be achieved.

**Satiation Feeding Guideline:**

- 80% satiation feeding gives best FCR but slower growth
- 90% satiation feeding gives most optimal growth rate and FCR
- 100% satiation feeding gives higher FCR but faster growth

Internal and external factors such as a disease outbreak or inclement weather may require adjusting the approach to feeding. Some species and certain life stages may have special feeding requirements and slight variations in the feeding regimen. The experience and willingness of workers to follow the specified practice will impact feeding effectiveness and efficiency. Feed allowance adjustments should be made anytime overfeeding or underfeeding is noted by the trained manager. Underfeeding is preferable to overfeeding in economic terms, but neither is desirable. As fish grow it is important to adjust the size of the feed pellet to optimize feed intake and production efficiency. Using the 90% satiation method described above improves survival, productivity, FCR and ROI.

**Figure 57.** Relationships among feeding level, growth rate and FCR (Ref. Lovell, 1989)(graphic: O'Keefe)



**Figure 58A – B.** Feeding fish in IPRS (note high density)



## SECTION 4.8: Seasonal Adjustments of Feeding Rates in IPRS

Feeding activity of fish varies with their species and metabolic rate, which is closely tied to the water temperature. When water temperature changes, so does the feeding activity of fish. To prevent overfeeding or underfeeding, adjust feeding rates as temperature changes. This temperature optimum is unique for all species. For many warm water species, in temperatures above 15C, satiation feeding will provide the correct amount of food required for optimal efficiency. If water temperature drops below 15C, warm water fish species are often reluctant to feed at the surface and satiation feeding may no longer be a reliable practice. Warm water fish will continue to consume floating feed when water temperature is between 15C-31C. But, as water temperature falls below 15C, continue to offer extruded floating feeds because the surface feeding response in raceway cells even at a cooler temperature is still robust and justifies the floating diet cost. During very high air temperatures and times when traditionally managed ponds are above 31C, IPRS ponds are generally found to be cooler due to WWU action and mixing of pond water. The mixing effect moderates temperature within the IPRS pond.

Because feed is the largest operational cost of any intensive fish farm, proper feeding practices can make the difference between profit and loss. The manager who takes a little extra time to observe feeding activity and adjust rates, to keep and maintain accurate records, and even to create custom

feeding tables, has a much better chance of achieving the high level of feed efficiency that IPRS offers.

**Figure 59.** Seasonal feed offering recommendations based on pond temperature

Temperature	Feed (body weight daily)
10C-15C	0.5-1.0%
15C-19C	2.0%
19C-30C	3.0%
34C-38C	0.5-1.0%

## SECTION: 4.9 Feed Storage: Maintaining Quality

Knowing that feed represents the highest cost component of the production budget it is critical that feed is protected as it is moved from the feed mill to the farm, stored on the farm and fed to the fish stocks. Heat and moisture are the primary short-term causes of feed spoilage.

The quality of feed milled with high quality ingredients may be maintained by storage in a shaded, cool and dry structure on the farm. Some micronutrients can be compromised if feed is old or has been stored poorly. Feed should be stored on the farm no longer than 14 days to maintain quality and nutrition. Preferably, it should be fed within 7 days of milling, if possible.

Farm managers should ensure that feed is dated and stored according to the date of milling, with a “first-in, first-out” strategy. A roofed and dry concrete structure is usually able to provide an adequate on-farm place for feed storage.

It should be dry, lighted and clean with precautions in place to prevent insect and rodent pest presence. Feed storage places can become a haven for insects and rodents if it is not kept clean and well maintained.

Some farms receive feed deliveries in bulk as opposed to bagged. For farms using bulk delivery, it is critical that feed is fed quickly as it is a false economy to buy feed in bulk to save on bagging cost only to hold feed in a hot, moist storage bin for several weeks or months. The “quality clock” of your investment feed begins ticking downward the moment it leaves the feed milling equipment. The performance of the fish and the IPRS investment is enhanced by feeding fresh high-quality feed.

**Figure 60A – C.** Photos of well-built feed storage for bagged and bulk aquafeeds





## SECTION 4.10: Feed Mill Relationships

Regular communication with your feed mill representative and general manager is important to your business. In many ways, your feed miller is a business partner, not just an associate.

Communicate your production methods and plans with your feed supplier, including how you will achieve your objectives. Feeding fish in IPRS is like feeding any other animal in confinement — they are fully dependent upon the quality of the diets they receive. Achieving a high survival rate of your fish crop is more important than rapid growth and is crucial for best ROI.

Ingredients, including binders in the ration, can have a large impact on how quickly fish fecal waste settles in the IPRS quiescent zone (QZ). This, in turn, improves the efficiency of the waste removal system and the resulting improvement in the water quality of the pond.

**Figure 61.** Farm and feed milling personnel planning meeting



## SECTION 4.11: Water and Water Quality Management in IPRS

Water quality and chemistry in IPRS ponds is managed for optimal assimilation of nutrients. The water throughout the pond is continually mixed, aerated and moved by the flowing action of the WWUs, thereby keeping the pond environment mostly aerobic.

When IPRS ponds are prepared before filling, the pond bottom is cleared of vegetation or organic debris, tilled and dragged smooth. Agricultural limestone is applied in ground or granular form to neutralize acidic bottom clays. After these measures are applied, the pond is filled with clean water that is free of fish eggs, fry or other competitor organisms. Most operators use 100 mesh Saran filter cloth or similar materials to effectively screen out and exclude unwanted organisms.

**Figure 62A & B.** Preparing ponds for filling



When the pond is 75% or more filled, apply a fertilizing regime to stimulate development of phytoplankton, zooplankton, bacteria and other naturally occurring beneficial biota. These are the primary assimilation organisms which process the large-scale organic loading from aquaculture. The conditions necessary for this biota to perform optimally require dissolved oxygen levels at or above saturation.

Photosynthesis by phytoplankton drives the primary source of dissolved oxygen for pond systems and is concentrated in surface waters that receive the most sunlight. Typically, this leads to stratification and results in hypoxic DO levels of bottom waters. IPRS technology uses WWUs to continually mix, aerate and move water around the pond. This process changes several components within an aquaculture pond. The mixing and movement of water causes an increase in the DO throughout the full water column from the pond surface to the mud-water interface on the pond bottom.

**Figure 63.** Application of lime in an empty pond



Phytoplankton species diversity in traditionally managed ponds is typically dominated by 1-3 species, however, in IPRS there is a dramatic increase in phytoplankton diversity and stability. Because of surface to bottom water column mixing by WWUs, the overall abundance of biota (phytoplankton, zooplankton and bacteria) is enhanced and allows for higher levels of organic loading. When operated properly, the IPRS allows addition of high-quality floating feeds on a sustained basis at rates of up to 300-600 kilograms per hectare.

Paddlewheels and other aeration equipment do not have the level of mixing and destratification with the same economy as WWUs in deeper commercial aquaculture systems. Although paddlewheel aerators are appropriate in some applications (shallow water), they are not recommended for IPRS operations. WWU aerators do a much better and more efficient job of mixing and gas exchange in actual pond environments than other types of aeration devices. Because WWU diffusers operate at about 0.8-1.2 meters of depth (depending on blower type) typically in sub-saturated DO water, their efficiency is increased especially compared to paddlewheels and other surface types of aerators that operate in supersaturated surface waters. SOTR and SAE of WWU's are superior to paddlewheel aerators.

Many IPRS facilities utilize water chemistry and water quality monitoring gear to display and maintain an on-going understanding of the production environment quality in the pond. In broad terms, ponds when managed according to IPRS principles are stable without the large swings in DO, pH, CO<sub>2</sub>, ammonia, nitrite and nitrate.

The continual mixing, aeration and moving of water through the raceways and around the full pond help develop the stability in water quality. Dissolved oxygen, for example, is far more stable and moderate in concentrations. DO is relatively homogenous from surface to the pond bottom. Afternoon DO spikes common in traditional ponds are less pronounced and generally not seen in IPRS ponds. Ammonia and nitrites are usually not a problem in IPRS because nitrifying bacteria are active and healthy in DO rich environments, which increases the assimilation rate of ammonia and decomposition.

Water exchange, in some areas, is frequently thought necessary in intensive open pond traditional aquaculture, but this is harmful to the environment and wasteful of limited water resources. The waste load associated with the production of fish is continually processed by the flowing aerated system and IPRS ponds do not require water exchange. The only required addition of water is that to replace seepage and evaporation losses to maintain full pond volumes. We do not recommend any water exchange from IPRS ponds. In many places, water is simply a limited resource and in other places the receiving waters may be nutrient sensitive or even of poorer quality than IPRS pond water. A financially better and more environmentally sound approach is to manage the pond water with care and not bring in unwanted competitor fish, pathogens, solids and pollutant materials from outside surface water sources.

See Appendix A: Understanding water chemistry for more detailed water quality information.

**Figure 64.** Application of fertilizer to pond to establish phytoplankton bloom





## SECTION 4.12: Confinement Gates

The flow of water from WWUs through the IPRS cell is largely regulated by confinement gates and their mesh size and percent open area. For most IPRS operators, it has become evident that replacement gates and gates holding different mesh or opening sizes are a significant asset for managing raceways on the IPRS farm. When maintenance needs require removal of a gate for cleaning or repair or when fish of different sizes are introduced into the cells, IPRS operators can benefit by having multiple spare gates; some for replacements and others with various mesh sizes for the different sizes of fish grown in the raceways. Gates are routinely maintained with brushing but require replacement if damaged or even to contain a different size fish crop.

In keeping with the need for robust water movement through the cells, the gates must be kept clean and free of any debris which impedes the flow and at the same time, the gate mesh needs to be of a proper size to retain the fish. Managers who have gates on-site with different size openings to achieve both objectives, typically experience better ROI outcomes.

Materials used for confinement gates must be robust and offer good long-term utility and compatibility for the fish, and they should have a smooth surface texture. Confinement mesh for developing advanced stockers from fingerlings requires material with small opening size at initial stocking, which becomes fouled and clogged more rapidly than large mesh sizes.

To maintain appropriate water flow rates, the mesh should be routinely brushed and cleaned free of debris and growth of fouling organisms. Some operators use “high pressure washers” to routinely remove any fouling and debris. The small-mesh material must be robust and strong to withstand the rigorous and frequent cleaning required. Netting materials of the types used for fish harvest (knotted or knotless) are not used for confinement gates.

Knotless mesh may be used for short periods after initial stocking to provide an acclimation “cushion”, which prevents abrasion from bumping up against the more rigid confinement gate mesh until fish learn their surroundings. Galvanized mesh wire or metallic materials will fail even in freshwater ponds.

For everyday use, confinement gates must be made with stainless steel mesh, PVC coated steel or similar materials for longevity and compatibility with the confined fish. Farmers who have selected gate mesh materials other than those mentioned here will most likely experience failure of some magnitude.

**Figure 65A & B.** Well-built confinement gates



**Figure 66.** Cleaning confinement gates fouled by pond organisms





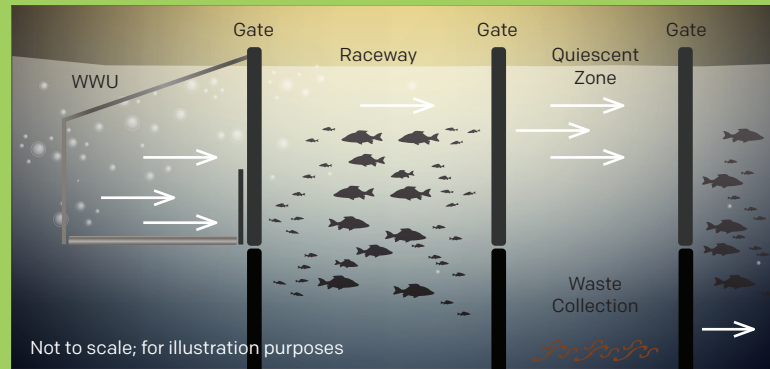
## SECTION 4.13: Solids Removal System and Management

The standard IPRS technology increases production dramatically by reducing the solid waste feces released by fish from entering the pond and by increasing the biological assimilation capacity of the pond to process suspended and liquid waste products. The minimum standard is to frequently remove as much of the settled solid waste as possible and practical through the use of the QZ and a mechanical solid waste separator system, and ideally, a process further downline to reduce the concentration of nutrients in any water returning to the pond.

Moderate nutrient levels in the pond water will help to maintain a stable algal bloom that produces dissolved oxygen and is a food source for the filter-feeding service species.

The objective of waste removal from the raceway QZ is to separate the settled solids from water as quickly and efficiently as possible to reduce nutrient loading in the pond. A significant portion of the organic debris and solid waste can be removed from the QZ with the mechanical system, but some suspended solids will remain in the pond and continue to leach nutrients into the water column. Where possible, remove the solids and further process the remaining water containing high nutrients through biological processes or nutrient scavenging by plants. Nutrients are an important component of a pond's healthy biological cycle, which relies on a steady source of nutrients, together with water mixing, to create and maintain a diverse, stable phytoplankton bloom.

**Figure 67.** Waste collection and removal in QZ (Kemp)



This bloom provides the largest source of dissolved oxygen to the pond.

### **Excess dissolved or suspended nutrients can be removed through biological processes that include:**

- Cropping of the algal bloom by service species
- Passing water exiting the solids removal system through additional settling vessels or through an aquaponics or "artificial wetland" before it returns to the pond
- Biological filtration

The planning process must consider the fate of the nutrient-rich solids collected from the quiescent zone. These solids have significant value and can be used for fertilizing, irrigating, organic mulch and/or biogas (methane) production. Waste removal, separation and processing must not be an afterthought; this system should be functional and ready as soon the IPRS is used. Failure to design and operate an effective settled solids removal and separation system means that essentially you will have a normal pond with expensive equipment in it and the likelihood of serious future water quality problems.

Solid waste removal systems typically employ vacuum and semi-solids pumps also called "trash pumps" to

move the pumps to move the settled solids from the QZ to settling basins where the solids settle again, and the clarified supernatant water flows out. During this process, the pump impeller action re-suspends and fluidizes the fecal pellet (nutrient-rich solids). If the slurry is not directed to settling basins it may feasibly be pumped directly onto crops via irrigation equipment.

Because these materials contain a considerable percentage of water, they are heavy and expensive to move any great distance. Some farms move the materials to land applications for fertilizing crops like rice, coconuts, lotus, grains, biofuel, trees and field crops. Larger IPRS facilities may collect the harvested solids in a container for digestion and extraction of methane commonly called biogas. After removal of the biogas fraction, the N, P and K nutrients remain available as plant fertilizer materials.

**Figure 68.** Application of waste solids can be used to fertilize agricultural crops



The key waste management principle is to effectively remove as much of the settled solid waste as possible from the IPRS cell, and then on land separate the solid waste from the slurry. The error most IPRS operators make is to collect and harvest the solids into a pond-side vessel and then allow the nutrient laden water (full of dissolved nutrients) to then be flushed back into the pond. Instead, the solids collection system needs to be frequently and fully emptied and cleaned to remove all liquid and solids. It is important to track and check the outflow water chemistry (ammonia, nitrites and nitrates) from the onshore systems to be sure any significant levels of nutrients are not re-entering the pond.

The confinement aspect of raceway-cultured fish combined with the flowing water presents an opportunity to collect and remove settleable solid fish wastes along with any other debris or detritus that settles in the QZ. The QZ is a 6-meter (expanded from 3-meter in previous versions) flat floor extension of the raceway. The walls and floor are gated off (fenced) from the raceway – containing the fish and fish from the open pond.

The gates prevent any fish from entering the QZ and stirring up the settled solids before they can be removed. It is comprised of two successive 3-meter long segments each of which is equipped with a separate solids removal system that collects and pumps the settled waste solids slurry out from the entire width of the raceway facility and into onshore storage vessels.

The dynamics of fecal characteristics from various fish species and diet formulations can vary widely. Some solids are settled more quickly than others, some are expelled as a loose “stool” rather than as a solid mass or consolidated pellet, and with some (tilapia), it is expelled as a fecal strand. Often the fecal strand develops gas bubbles and becomes a floating, stringy-type feces. The settling rate of raw waste particles can be enhanced by the addition of some feed binding ingredients, such as guar gum. Settlement of raw waste particles with no augmentation or amendments to feed has been successful in some IPRS facilities and species. In recent trials with trout, a small amount of guar gum was added to the standard diet and compared to the same diet containing no guar gum.

The amount of manure solids collected was significantly greater with the guar gum added to the feed than without. Guar gum may have some palatability factors; consequently, this should only be done on a small-scale test before committing to large scale use.

The fish held and fed in the raceway cells spend most of their time in the upstream portion of the cell so most fecal solids they release settle in the raceway itself before reaching the QZ. The velocity of flowing water through the raceway and the swimming action of fish concentrated in the system sweeps the solids into the QZ. Depending upon the type of feed, ingredients and the size of the fish fed in the system, the volume of solids can vary but the amount settled and harvested is significant.

Two types of waste solids removal gear have been developed for the QZ. The first type uses a stationary pump and a moving vacuum head (or dredge-type). This system employs a vacuum head that travels via cable which draw it from side to side on rails affixed across the bottom of the QZ.

**Figure 69.** Collecting tilapia fecal strands on gate mesh and using wedge shaped collector



**Figure 70.** Rail mounted solid waste pumping system that pumps water to sloped trough



The pump pulls out water and solids slurry and its outflow delivers material via a 6-8 cm pipe into an onshore storage vessel. The second solids removal system uses a moving platform holding the pump traveling on rails and has a hard attachment to the vacuum dredge on the bottom of the QZ. In this model, the suction head is suspended from the rail-mounted car fixed underwater; it travels slowly across the bottom and vacuums up settled solids via the above-water pump. The slurry is emptied into a slightly tilted trough which runs the width of the QZ and deposits it in an onshore storage vessel.

It is important to frequently remove the settled waste from the QZ, because it continues to release nutrients into the passing water until it is removed. If manual removal is practiced (not recommended), the QZ should be cleaned at least twice daily. If recommended mechanical gear is used the QZ should be cleaned 4 or 5 times daily. Typically, a QZ cleaning using mechanical gear is described as one full pass of the suction (vacuum) head. That is, "out and back" is one pass. Most often, a single pass is sufficient because the next cleaning event follows in 5 hours or less. (See Appendix G for suppliers of solids removal gear and equipment). The onshore waste storage facility is comprised of 3 vessels.

Typically, the vessels are located as close in proximity as practical to the QZ and formed from brick and mortar with a poured concrete floor or with formed concrete. In areas with a high water table, it is important that the vessels are built on top of the levee or in surrounding ground such that they have no possibility to "float" after stored slurry is removed.

The storage system interior dimensions should typically be 9 m long, 4 m wide and 1.5 m deep (or a shape holding similar volume depending on available space or terrain). The vessel structure should be designed to hold and handle the expected full weight of water slurry. The 9 m box-vessel is subdivided into three segments: 4.5-meters, 2-meters and 2.5-meters long.

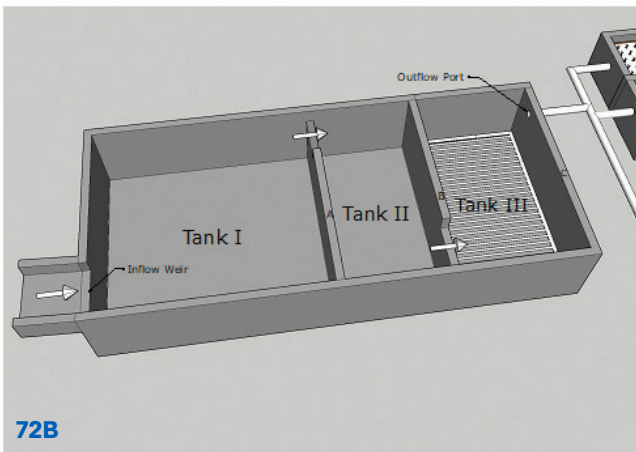
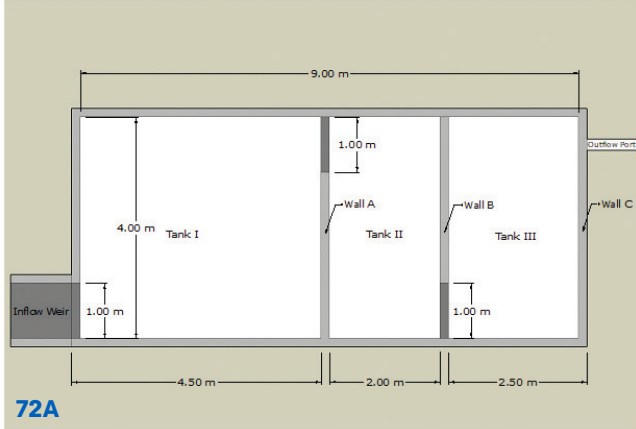
These represent internal dimensions; the actual dimensions will be slightly different considering the actual wall thickness. They are referred to as: primary (4.5 m), secondary (2 m) and tertiary vessels (2.5 m). If space is limited on the levee or site for the storage vessels, the shape may be altered to a more elongated form where the system is 2 m wide and 18 m long with the primary vessel now 9 m long, the secondary vessel 4 m long and the tertiary vessel 5 m long.

The waste slurry is delivered to the onshore primary vessel. Its function is to settle as many of the solids as possible (4.5m x 4m x 1.5m). Water should not fall or experience high turbulence when entering the tank as the desired outcome for solids to settle to the bottom of the primary vessel and not be re-suspended. To accomplish this, a broad entry channel extending optimally across the full width of the vessel inflow weir is installed to include a denticular overflow panel or across a 1-meter wide weir and onto a floating energy dissipating material. These approaches allow the water slurry entry energy to be dispersed as it enters this end of this vessel.

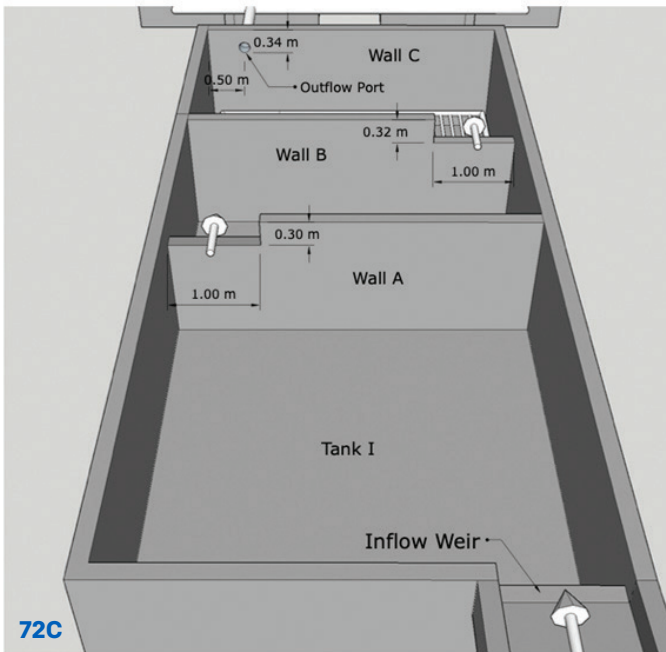
**Figure 71.** Cable operated solid waste removal system uses pumps to vacuum waste slurry to onshore storage tanks







**Figure 72A – C.** Illustrations and details of onshore waste settling and holding vessels



A separation wall is installed between the primary and secondary vessels with an overflow opening weir (at least 1m wide x ~30 cm deep) opposite (not across from, see diagram) the inflow weir receiving water from the QZ. This allows water to gently pass over the primary weir opening at full load with as little turbulence as possible

The secondary vessel (2m x 4m x 1.5m) functions as the settling area for solids not settled in the primary vessel. Typically, the majority of solids have settled in the primary vessel, but the second tank adds further residence time for solids to settle. Particles in the secondary vessel tend to be smaller and light weight.

A wall is installed between secondary and tertiary vessels with an opening (at least 1m wide and 2 cm (32 cm) deeper than wall A) opposite (not across from, see diagram). Water from the primary and secondary vessels and openings passes into the tertiary vessel. The opening

weir allows water to gently cross the wall opening at full load with as little turbulence as possible to the receiving vessel.

The tertiary vessel function is the treatment/polishing element of the storage facility (2.5m x 4m x 1.5m) This area should be heavily aerated (using a blower system linked to a WhiteWater-type air tubing grid or diffuser discs to stimulate a biofloc system to assist with the nitrification processes.)

Wall C is an outer wall of the solids collection vessel and the outflow from the tertiary vessel can be either a large opening as the other two walls or through a large diameter pipe. In either case it should be at least 2 cm deeper (lower elevation) than the opening of wall B and located opposite from the opening in wall B (see diagram). The water exiting the tertiary vessel can be sent directly to the production pond or further treated to remove dissolved nutrients through other oxidation methods.

Water can be returned to the pond from the tertiary vessel, but typically, it is directed to a long shallow trough where plants may be grown to utilize the dissolved solids as fertilizer. Solids can be pumped from the bottom of the primary and secondary vessels and moved off-site though use of a solids-handling or mud pump. Some operators use “screw-type” pumps for slurry removal. It is helpful to fluidize these materials to allow the mud pump to function more efficiently. Solids from the primary vessel should be removed at least once a week from the bottom 25% of the tank volume after the top 75% volume is decanted.

Similarly, solids in the secondary vessel should be removed as a slurry from the bottom 25% of the tank volume (the top 75% volume should be decanted) minimally every two weeks. The primary vessel should typically yield about 7 m<sup>3</sup> of slurry water and the secondary vessel about 3 m<sup>3</sup> of slurry water.

A transport tanker container with the appropriate volume should be prepared if this is going to be transported elsewhere.

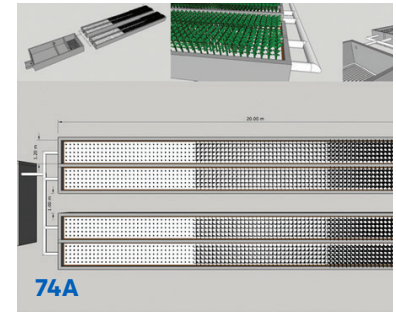
*Note: To efficiently remove the solids Use the following approach:*

1. Decant (pump off) the water to a point close to the top of settled solids
2. Mix the remaining volume containing solids and water to create a slurry that can be pumped
3. Use a solids-handling pump to transfer the waste slurry to an outside transport container
4. Water decanted from vessels 1 and 2 is either pumped on board the transport tanker or into the tertiary vessel for settling and passage into the next nutrient re-use element

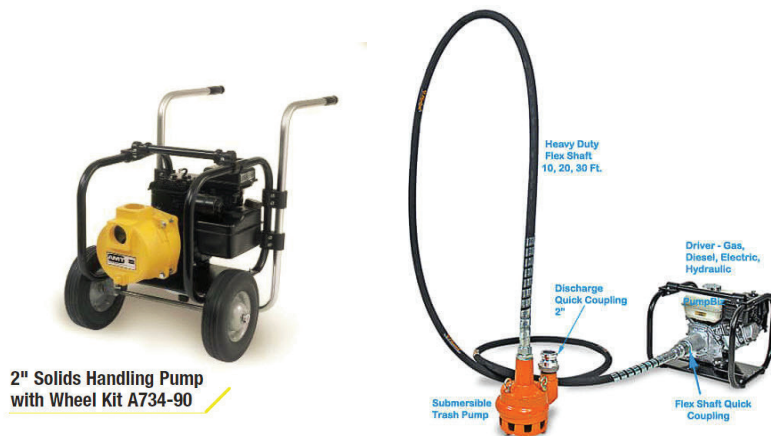
Nutrient rich water from the tertiary vessel can be used to provide nutrients for plant production on-site or further treated to process waste nutrients. Plants are often used to remove dissolved nutrients, especially leafy greens, such as kang kong in Asia. The area allocated for plant production depends on the plants being cultured. Troughs of 20 meters in length and 1.5-2-m wide are suggested. Water depth should approximate 50 cm. This water should be moderately aerated to maintain plant root health. For a three cell IPRS facility, 4-6 plant production troughs are suggested through which water will be discharged and then returned to the production pond. Flow through these plant troughs is by gravity.

Nutrients not absorbed by these plants may be returned to the pond where they will be assimilated by the phytoplankton pond and grazed upon by service species.

**Figure 74A – D.** Dissolved nutrients leaving the tertiary segment (Tank 3) can be scavenged by plants in aquaponics, vegetables cultured on floats, fruit trees and artificial wetlands



**Figure 73.** Solids handling pumps used to remove solids slurry from onshore storage vessels



## SECTION 4.14: Floating Waste Solids

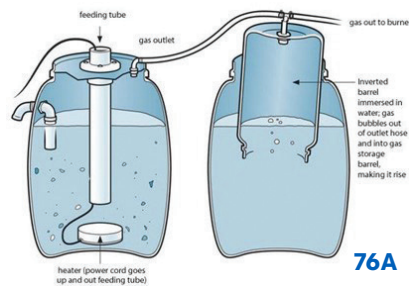
For some fish species, such as tilapia, fecal matter may not all sink, and some portion of the solids may float on the surface. The typical approach for collecting these “fecal strings or strands” in the QZ will not be as effective. Changing the feed formulation may help prevent or reduce this from occurring.

If this condition persists on a farm, collect the fecal strings manually to prevent them from entering the main pond. Some operators culturing tilapia are seeing considerable levels of fecal strands hanging all across confinement gate mesh. To localize the collection of fecal strands, a chevron or wedge shaped deflector can be used to cause most of the strands to collect along the raceway wall. This makes their removal more easily done.

Manure has many uses and values. It is valuable as an organic fertilizer and can be applied in slurry form. Biogas (methane) is an available by-product digested and extracted from the solids. Other products such as organic mulch are being

developed from the fish manure which will return revenue to the investment made in feed. Because it is removed from the pond, the waste load that would have been borne by the pond is significantly reduced. The full magnitude of this action as it impacts the pond environment is not yet fully understood, but the current carrying capacity of the IPRS pond is clearly enhanced over traditional ponds.

**Figure 76A & B.** Small-scale and commercial-scale biogas reactors



## SECTION 4.15: Fish Health Management in Raceways

Managers who act to manage fish health in traditional ponds with the objective of stock survival above 90% will be successful with IPRS. Begin with stocking healthy fingerlings to maintain the IPRS facility to optimize survival of stock through the cycle to harvest. Healthy stocks are fed high quality complete and balanced soy-based, extruded diets and are held in a stable environment where water chemistry parameters are optimized. Dissolved oxygen (DO), for example, is managed to remain above 3.5 mg/l. Target DO is always at or above saturation at a given temperature. Other water and environmental parameters (ammonia, nitrite and carbon dioxide) are optimized using the IPRS gear and management of the flowing water pond.

## SECTION 4.16: Fish Health Management Protocols:

In the real world, we have to manage fish health and sometimes disease outbreaks. Most often, the best fish health management is prevention, not treatment, of an outbreak. Experienced operators anticipate seasonal temperature changes or storm effect and will treat stock prophylactically or withhold feed during short but stressful periods.



**Figure 75A & B.** Floating fecal strands attach to confinement gates, but they can be collected by diverting them to the wall where they can be manually removed.





Below are several therapeutants and treatments for both prophylaxis and treatment to maintain stock health. Our most important job in aquaculture is to keep our animals alive. High survival levels drive and are always highly correlated with attractive ROI. The health of fish stock is managed according to the general protocol described below:

- A.** Use appropriate prophylactic treatments on all fingerlings and stockers before stocking both fed species and unfed service species. The treatments should address the control of skin and gill parasites and external bacteria.
- B.** Additional prophylactic treatments are conducted at intervals after stocking and feeding has begun.

**C.** All therapeutants used in managing fish health must be registered for use in food fish production. We provide guidance on four, they are: Formalin, Potassium Permanganate, Copper Sulfate and Hydrogen Peroxide.

**D.** Treatment rates (concentration of therapeutants) and frequency are applied as follows:

- 1.** Formalin-(37%) applied at 125 mg/l for 1 hour or 250 mg/l for 30 minutes
- 2.** Potassium permanganate applied at 20 mg/l for 30 minutes to 1 hour
- 3.** Hydrogen peroxide: (35%): 50 mg/l for 1 hour
- 4.** Copper sulfate: 1-4 mg/l for 1 hour.

Always refer to approved uses on the label of products or use according to label instructions.

Remember copper potency (toxicity) is greatly influenced by alkalinity, so the concentration is calculated using current alkalinity reading on the water by the following formula:

$$\text{Total alkalinity mg/l} / 100 = \text{copper sulfate needed (mg/l)}$$

For example: If you measure alkalinity at 130 mg/l; then  $130/100 = 1.3$  mg/l copper sulfate is the correct treatment level for chemistry of this water.

**Figure 77.** IPRS Planning Tool and Calculator for Therapeutic treatment amounts and costs (Kemp)

### CHEMICAL TREATMENTS

This tool determines amount and cost of therapeutant treatments. Costs may vary by region, product and over time.

**Directions:** Enter user data into the orange boxes.

Therapeutant	Price/Kg	Rate of Application	Raceway PZ Volume	Amount to Use	Cost	Compared with Pond (10,000m3)
Potassium Permanganate	USD	mg/l (ppm)	m <sup>3</sup>	Kg		
Examples	\$6.00	5	220	1.1	\$6.60	\$300.00
	\$6.00	10	220	2.2	\$13.20	\$600.00
	\$6.00	20	220	4.4	\$26.40	\$1,200.00
Other				0	\$	\$
	Price/Liter	Rate	Raceway Volume	Amount to Use	Cost	Pond Comparison
Formalin	USD	mg/l (ppm)		Liter		
Examples	\$7.00	25	220	5.5	\$38.50	\$1,750.00
	\$7.00	75	220	16.5	\$115.50	\$5,250.00
	\$7.00	125	220	27.5	\$192.50	\$8,750.00
Other				0	\$	\$

*Notes: Use only approved chemicals and rates. Follow proper protocols. Determine Permanganate demand (in ppm) and add to the intended treatment rate. Be sure to calculate the volume correctly including differences in water level/depth.*

## SECTION 4.17: Treatment Rationale

A sample group from all fish to be stocked should be microscopically examined before transport to the IPRS facility. Gill and skin tissue should be examined for the presence of parasites and the findings noted. Following the examination, treatment options should be considered. From currently approved options, USSEC has seen success with treatment with formalin at 125 mg/l for 1 hour preferably. The fish will then be rested overnight before transport or stocking. A few days following stocking, fish in all raceway cells will receive a second anti-parasite treatment with the materials listed above and at intervals over the course of the culture. USSEC recommends the use of approved products for treatment of identified fish parasites which may vary by country.

## SECTION 4.18: Applying Treatments in Raceway Cells

**When applying treatments, the following protocol should be followed:**

- Withhold feed temporarily from the group to be treated
- Determine the approved therapeutant, concentration and duration of treatment
- Calculate, recalculate and measure the treatment material
- Mix the treatment material in 2-4 buckets (20 L) of water to dilute before application
- Place a weighted curtain, such as a plastic sheet or tarp, over the downstream confinement gate to close off water flow through the raceway

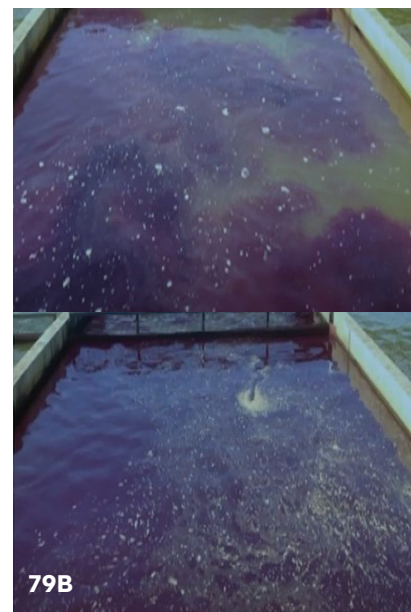
**Figure 78.** Microscopic examination of gill filaments and other fish tissues can reveal parasite or bacteria problems



**Figure 79A & B.** Treating a research-scale raceway with potassium permanganate



- Continue operating the WWU at the head of the cell; activate supplementary air system
- Apply treatment material evenly across the cell water surface to avoid any hot spots
- **DO NOT leave the presence of fish under treatment at any time. Observe fish for any out-of-the-ordinary behaviors or signs of stress**
- After the treatment time has elapsed, remove the curtain from the downstream gate and allow water to be flushed through the cell and into the open pond, thus completing the treatment



## SECTION 4.19: Treatments will be Applied Seasonally as Follows (varies with species)

- Winter with water temp below 12.5C (55F), treat 1 time every 14 days
- Spring with water temps between 12.5 – 24C (56-75F), treat 1 time each week
- Summer with water temps between 24-29C (76 and 85F), treat 1 time per 14 days
- Autumn with water temperatures between 12.5-24C (56-75F), treat 1 time per week

## SECTION 4.20: Notes from Experience

1. Dissolve or dilute treatment materials in water prior to administering to the raceway system. Avoid application “hot spots” due to the relatively small culture volume.
2. Administration of therapeutants to IPRS can be stressful to the fish. While any treatment is being applied, stay with the fish undergoing treatment to monitor their stress levels and terminate the treatment to avoid any treatment-induced mortality.
3. The concentration of materials used to combat primarily external parasites, and, to a lesser degree, external bacteria are applied for specific periods of time. For example, fish are more sensitive to a treatment if they are stressed from a parasite infestation. Remain on site until the treatment is terminated and flushed from the raceway cell.

**Figure 80.** Careful calculation of the raceway volume using depth markings on the walls and accurate amount of chemical treatments are critical.



## SECTION 4.21: Active Management of Fish Health

### Prevent, Manage, Identify, Treat:

- **Prevent** – Use high quality, well fed, treated fingerlings. Good management practices and apply a proactive health management plan.
- **Maintain** – Control outbreaks using the best short-term approach, such as withhold feed, remove sick fish and treat. Identify a longer-term approach and implement it.
- **Identify the cause** – Determine whether the disease is caused by an environmental issue such as abnormal water quality parameter, a parasite, bacterial infection or combination of issues.
- **Keep records** – A critical part of fish health management on any farm – it can help identify the type of disease and indicate what may happen as the disease develops or progresses. Examination and analysis of samples by a trained farmer and at a professional laboratory is important to determine best treatment options, particularly for bacterial or viral disease.

- **Develop a sheet or chart** – Clearly spells out in detail the amount (weight or volume) of any therapeutant you might expect to use. These should be specific for particular parasites or bacterial pathogens, species of fish, age/size of fish, water temperature, chemistry or other conditions and so forth. This tool helps reduce possible mistakes applying materials which can kill fish if dosage calculations are in error.

## SECTION 4.22: Protocol for Sampling Diseased Fish for Analysis

### Live Samples (preferred):

- Obtain 5–7 live fish showing signs of disease, moribund individuals and an equal number of healthy fish from the culture facility.
- Pack them separately in clean, culture water at an approximate weight of 150 grams of fish per liter of water.
- Aerate or diffuse oxygen into water and flush air from the bag.
- Place sealed bags in an insulated foam box to stabilize temperature. Include small, newspaper wrapped packs of ice or gel-packs when traveling long distances and during hot weather.



**Figure 81A – C.** Proper shipping procedures for shipping fish include clipping spines off catfish, keeping ice separate from fish and using a sturdy shipping/transport container



- For larval, post-larval or fry stages, pack at least 20 diseased individuals and the same number of normal fish in the same manner.
- Transport to aquatic veterinarian for examination and analysis as quickly as possible.

If few or no moribund (sick) fish can be secured, dead fish can be shipped in an iced package.

**Iced Samples (not preferred and the fish shipped should have very recently died):**

- Obtain five diseased individuals and an equal number of normal fish from the culture facility and pack separately in sealed plastic bags.
- Place bagged samples in between layers of wrapped ice in an insulated foam box.
- Transport for examination and analysis.

**Include the following in the boxes for transport:**

- **Name of farm, location and contact information**
- **Farm type** (cage, pond, raceway, etc.)
- **Water type** (fresh, brackish, marine)
- **Sample:**
  - Species
  - Age/Stage
  - Sample size
  - Time sampled
  - Type of sample (live, iced, frozen, fixed, etc.)
- **Additional vital information** to record and provide to veterinary professionals
  - Initial date disease signs were detected
  - Time between first appearance of disease and death (days)
  - Implemented treatment(s) if any
  - Specific disease signs

- Mortality pattern (gradual or sudden)
  - *Swimming movement/ position*
  - *External lesions/deformity*
  - *Distribution of disease in the farm system*
- Condition and quality of rearing water:
  - *Not filtered, Filtered*
  - *(Micro/Screen/Sand, etc.)*
  - *UV treated (Chemical/UV/ Ozone)*
  - *Any indications of poor water quality*
- **Feeding:**
  - Type (formulated feed, etc.)
  - Feeding rate and approach
- **Any other fish in the system?**
- **Any recent introductions** and/or the origin and date of introduction culture system

## SECTION 4.23: Harvesting from In-Pond Raceways

Because fish are already in confinement, harvest from raceways is simple and inexpensive. There is no need for standard seining equipment to harvest fish from IPRS. As fish reach the target size, determined by sampling, the harvest is scheduled in coordination with the market or business segment that will receive the fish. Typically, fish are harvested and then transported live to the next part of the value chain. If fish are handled roughly and are stressed, their quality and weight will decline as they enter the market. The longer shelf-life and market quality of properly handled fish has much greater value to your customer.

The harvest process begins by carefully crowding only a portion of them to one end (typically the up-stream end of the raceway using a frame which is able to slip easily into the 2.3m x 5m raceway structural dimension. The frame is typically nominally 4m x 5m and is light weight but rigid material. This frame is fitted with a net bag of the frame dimension and includes a 3-meter deep bag. This net device is used to catch relatively small portions of the whole population in the cell. Fish are removed from the water with soft harvest nets or via special vacuum pumps designed for moving fish quickly with minimal stress and labor. Do not catch all fish in the raceway at once, instead use the crowder net to take out smaller, manageable amounts of stock. This favors handling high quality live fish that demonstrate better visual quality and a longer “shelf-life” for your customer.

Roughly handling fish, as typically occurs in traditional pond harvests, causes significant scale loss, skin damage and stress on the fish. Many IPRS operators gain marketing advantages from buyers over fish coming from traditionally managed ponds due to fish health, meat quality and carcass yield. In cooler weather months fish can be more easily harvested and marketed live, however in warmer months and tropical locations more care should be taken when handling fish to reduce stress during harvest and live transport. IPRS allows for harvesting with less stress on fish and with minimal labor. Most modern production systems for harvesting fish require far less labor and time to move live fish stocks to market. Harvesting IPRS correctly using known harvest techniques allows the opportunity to supply premium quality products to a processing facility or to a marketer of live fish.

Figure 82A – C. Harvesting fish in China, Thailand and Vietnam



# SECTION

## Maintenance of In-Pond Raceway Systems

Gear and facility maintenance is an important daily work element and should be a line-item on every farm production budget. Facility maintenance includes keeping and maintaining spare gear, parts and a written schedule and protocol. Because IPRS is a more mechanical technology than traditionally managed ponds, maintenance is mandatory and should be prioritized.

**Remember — maintenance doesn't cost money, it SAVES money.**





## SECTION 5.1: WhiteWater Units

Most aeration equipment is expensive to purchase and even more expensive to maintain. The WWU operates with an electrically powered blower used to push large volumes of air through a set of high efficiency diffusers and consequently requires little maintenance. The air filter canisters attached to the blower filter debris from incoming air. They can be protected with fine-mesh nylon stocking material or similar small mesh pulled over the air filter canister. Operating the blower without a pre-filter stocking requires cleaning every 1-2 weeks. Maintain the filter canister by rinsing in warm soapy water every six months. Most blowers employ sealed bearings, but some are equipped with grease fittings that require one or two applications of grease on a quarterly basis.

Air diffusers require periodic maintenance because the surface of the diffuser develops a living biofilm that can grow to cover much of the diffuser surface. Monthly brushing can control this growth, but on some farms, diffuser care may be needed every 1-2 weeks. Quarterly or semi-annually, remove the diffuser racks from the water and thoroughly clean using a pressure washer or similar device.

Observe the air and water mixture and rate of flow coming from the WWU. There should be a uniform number of bubbles across the lip of the hood. The diffuser grid, affixed under water, should be level with the plane of the water surface. The diffuser is typically placed at a depth of 0.75-1.2 meters depending on blower type.

This immersion depth is dependent on the blower type and horsepower. The lip of the WWU hood should also be level with the water across its width. The angle of this hood is most efficient in terms of flow output strength at 33-35 degrees above horizontal. An uneven flow is evidence of unbalanced flotation or diffuser clogging from biofilm growth. Observing large bubbles and a gushing of water and air is not typical of normal flow patterns. This may be caused by a disconnected or broken diffuser tube. Broken tubes may occur after several months or years of operation. The tubes can be replaced after removing the diffuser rack from the WWU.

**Figure 83.** WWU operating properly: notice the even flow of water all the way across the lip



**Figure 84A – C.** Blower filters and WWU must be removed periodically for cleaning and maintenance





**Figure 85A – D.** Confinement gate maintenance



## SECTION 5.2: Confining Gate Mesh

Both upstream and downstream gates require vigorous brushing with stiff utility floor broom or brush. The stainless steel or PVC coated steel gate mesh provides an excellent environment for growth of benthic and periphyton fouling organisms. A low level of maintenance is required to keep them free of debris and biofouling to allow maximum water exchange. Start the cleaning process on the upstream gate so that any freed debris that becomes trapped on the downstream gate can be subsequently removed. To make sure rate of flow through the cells is up to standard, conduct a flow test as described earlier on a monthly basis to compare with earlier flow data.

## SECTION 5.3: Raceway Walls

Periodically inspect the surface of raceway walls for any growth that may be becoming established, however problematic fouling growth has not been observed on most IPRS. Check for structural integrity issues such as cracking that might be the result of wall settling. Incorrectly established walls can fail and cause significant financial loss.

## SECTION 5.4: Waste Solids Removal Gear

Because the waste solids removal gear is typically operated 2–5 times daily, it must be observed and inspected frequently. Careful weekly servicing of this gear is important because it is mechanical and out of sight (under water).

For personal safety it is important to conduct inspection of the waste removal gear, electrical connections, mechanical elements and onshore storage vessel in pairs of workers. None of the gear need be operational when being serviced, but sometimes, the gear must be observed in operational mode to check for problems.

**Figure 87A & B.** Regular inspection of the solid waste removal system is critical



**Figure 88.** Mechanical solid waste removal equipment: Vietnam



**Figure 86.** Maintenance of IPRS programmable waste removal gears





## SECTION 5.5: Baffle Wall

The baffle wall is seldom problematic, but occasionally, baffles may fail due to improper material or installation in the pond. The baffle should be inspected on a monthly schedule for rips, holes or deterioration. Frequent attention can help operators avoid major problems. Failures from wind action are more problematic with High Density Poly Ethylene (HDPE) curtain baffles than with earthen baffles.

**Figure 89.** Poorly installed baffle, not likely to function correctly  
**Figure 90A & B.** Well-built and properly installed HDPE baffle



## SECTION 5.6: Backup Generator

Backup generators must be checked and tested weekly. Do not rely on the simple start and run cycle that may be programmed in most new generators. Force the unit to respond to actual electrical power interruption by shutting down power at the main breaker panel or transfer switch. Allow the auto-start mechanism to operate, run the generator and start all blowers. Allow it to generate sufficient electrical current to run all critical electrical equipment just as if the power failure was real.

### The purpose of the transfer switch is to:

1. Release your system from line power and operate blowers on your WWUs attached to raceway cells.
2. Disconnect your generator from the main supply line. Do not risk electrocuting a utility worker trying to restore your electrical power.

**Figure 91.** Auto-start generators should be inspected and tested weekly under operational load



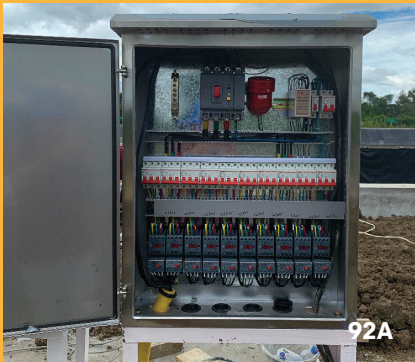


## SECTION 5.7: Electrical Switch Cabinets and Connections

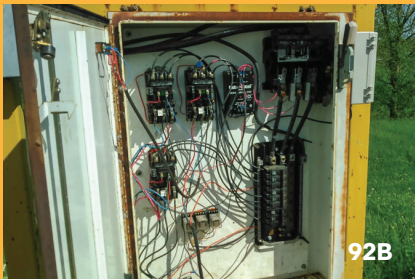
Most farm environments have an abundance of insects and other organisms which make homes or feed on other insects around ponds and lighted areas. As a result, many farms find it an important practice to inspect and clean electrical switch cabinets on a monthly basis. With insufficient care and attention, ants, spiders, frogs, snakes and plant vines often blow fuses, create connection failures or trip breakers.

**Figure 92A & B.** Examples of properly developed and maintained electrical control cabinets

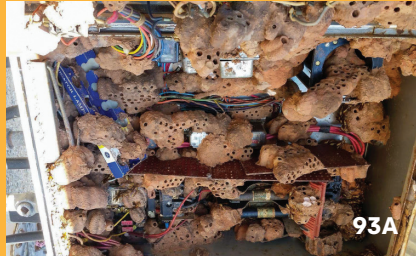
**Figure 93A & B.** Poorly built and maintained electrical control boxes contribute to accidents and injury



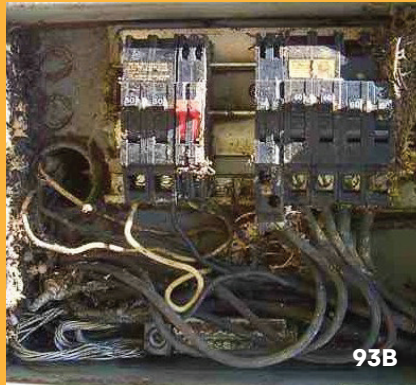
92A



92B



93A



93B

## SECTION 5.8: Programmable Feeders

Many IPRS operations utilize programmable feeders for the bulk of their feeding. Follow the maintenance points in the user manual and service per their operation instructions. Occasionally, electrical surges due to storm or electrical power interruptions cause loss of automatic feeder function, prescribed schedule or feed ration allocation. Don't assume all is operating correctly without regular checks.

**Figure 94A – C.** Programmable feeders are excellent operational tools, but they do require maintenance



94A



94B



94C

## SECTION 5.9: Replacement Blowers

Spare blowers are kept on the IPRS farm because they are such a critical part of IPRS technology. Some equipment vendors like to install spare units “in-line” to speed up and simplify any changeover. However, the change of one blower for another may be done quickly if the necessary fittings, and connectors are already pre-installed on the blower. To make a transition simple, reliable and safe, pipe unions and electrical connectors for faster connectivity and safe operation can be easily installed before they are needed.

## SECTION 5.10: Feed Storage Area

A well-lit, orderly and clean feed storage area is essential in maintaining quality in stored feed. Weekly inspection of local feed storage to avoid establishment of insect or rodent pests can avoid expensive losses of feed quality or wastage.

## SECTION 5.11: Power System

In a short period of time (minutes) – water movement inertia in the system will likely prevent any serious issues. Water flow will not immediately stop. Long periods of time (more than a few minutes) – could be catastrophic.

IPRS is designed to be a continuous flowing water system. If the water stops flowing for an extended period and fish density in cells is high, fish will likely become stressed and may die (or die later from stress-induced issues).

## SECTION 5.12: WhiteWater Unit

**Dirty, clogged or loose diffuser tubes** – bring about lack of efficient aeration and water movement. As diffusers are fixed in racks, the entire rack or system of racks, may be compromised by a single damaged tube or fitting on that rack.

**Damaged hood** – will no longer direct water flow correctly through the raceway cell or around the pond as designed.

**Failed blower** – without correctly functioning blower(s), fish held in raceways are at risk. Without water flow and mixing as designed, the pond biota can no longer assimilate the waste stream as designed for IPRS.

## SECTION 5.13: Supplementary Aeration System

**Failure of system** – may foster fish becoming stressed and eventual death. This system adds to oxygen requirements for a system at high biomass levels as fish approach market weight and for unusual events where oxygen levels are low (overcast periods).

## SECTION 5.14: Gate Mesh

**Holes in mesh, wrong size mesh or any failure of confining mesh or frame** – IPRS is based on the fact that the feed-based target species are cultured and confined in the raceways. If fish escape by a failure of the gate or holes in the mesh, then there is no longer an IPRS, just a pond system with a lot of expensive equipment.

Figure 95A & B. Photos of well-maintained bagged feed storage facilities



95A



95B



## SECTION 5.15: Automated or Programmable Feeders

- **Not operational** – may lose opportunity to grow fish.
- **Not functioning properly** – may overfeed and waste money or underfeed and lose growth potential.
- **Damaged feeds** – cause “fines” (dust) which are lost and may increase nutrient load in the water.
- **Reprogramming** – IPRS operators need to be trained to quickly re-program feeders after any failure or just due to accommodate feeding regime changes as fish grow and need more feed or after harvest and a cycle is complete.

## SECTION 5.16: Waste Collection System

- **Not operational** – may have buildup of solid waste in the QZ with continual leaching of nutrients into the system and negatively impact pond water quality. IPRS technology is based on removal of as much solid waste as reasonably possible.
- **Not functioning properly** – may cause failure of the system or cause resuspension of settled solids into water column and loss into pond (increasing nutrient load and reducing water quality – adding stress to fish, etc.)

For more information  
about IPRS, contact  
[IPRS@ussec.org](mailto:IPRS@ussec.org).

## SECTION 5.17: Waste Storage System

- **Failure** – if waste re-enters the pond, then the nutrients removed are added back into the system, and water quality may suffer.
- **Insufficient volume or emptying frequency** – may not function as planned, or fail, by putting removed nutrients back in the pond and thereby deteriorate water quality.

## SECTION 5.18: Water Baffle Wall

- **Failure** – IPRS uses a directed water flow, “river in pond” system. If the baffle fails, water is no longer correctly mixed and directed around the pond as intended and water quality will suffer. In an extreme case, the infrastructure is no longer IPRS and fails as a system.

## SECTION 5.19: Exceeding Biomass

IPRS is designed to allow farmers to increase yields dramatically from a traditional pond and a given water volume, but there are limits.

USSEC has tested the IPRS for many decades and has set upper limits on what is considered maximum target biomass levels where fish are not unduly stressed and can perform to expectations.

Some farmers may try to exceed these levels, and while it may work for a short time, they are taking a significant risk.

Exceeding biomass limits can lead to loss of a complete crop in the entire IPRS pond, not just a single cell. Production should always be staggered across cells for correct operation of IPRS. Therefore, peak biomass for the pond is never reached. This helps to reduce pond overloading and risk of failure.

## SECTION 5.20: Over-building the Facility

Some farmers do not fully understand the IPRS principles and do not seek help. They build far more production cells and capacity than their pond volume can possibly support. The principle is one standard production cell holding 220 m<sup>3</sup> requires 10,000 m<sup>3</sup> for balance and proper function and handling the waste load for IPRS.



# SECTION

## **Record Keeping and IPRS Performance Monitoring**

"We cannot improve on what we cannot control. We cannot control what we cannot measure. We cannot measure what we cannot define."

-Dr. Kim Koch

# 6

Record keeping for most farmers is a task they enjoy least about growing farmed fish. But for farmers whose objective is to optimize investment in their time, energy and financial resources, they view recording data and keeping records as powerful management tools in operating and improving their business efficiency and profitability. Record keeping is a vital part of managing any business, especially aquaculture, where the product is not always visible to the farm operator. Good records of your business can directly impact and improve your relationship and credit at the feed mill.

On the farm, record keeping can be valuable as an ongoing animal health management tool. If business or crop insurance is of interest to you, carefully kept records tracking details describing your operation will be required by any insurance underwriter. Farmers may complain about the time necessary for keeping farm records, but the records are not the end goal.

The value of records are in the analysis of the data you have recorded. It is difficult to improve your business efficiency if you do not have the data needed to analyze what you did, the results and how it impacted you financially. Historically, records have been entered in paper spreadsheets or record books, however modern record keeping includes electronic methods of monitoring, collecting and recording useful data. USSEC has worked with advanced data gathering and analysis equipment.

**Aquanetix** – This is an example of a browser/app combination that allows real-time record collection, project assessment and analysis. There are a number of other similar products on the market today.

**The value of keeping records is not only in the keeping. Rather, it should also regularly be analyzed to improve your business.**

#### Do NOT rely on memory for:

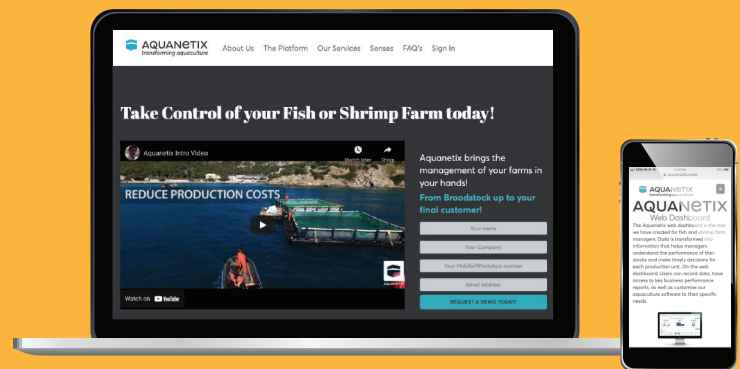
- Fingerling sources
- Batches
- Dates of grading
- Transport and delivery
- Pre-transport treatments
- Loss of fish after stocking
- Records of feed intake
- Response to feed applications

These are appropriate to record and analyze to improve your business. Any professional fish health analysis or routine evaluation of samples, as well as records of treatments, applied prophylactics or control measures for diseases or parasites, are extremely valuable to farmers and insurance underwriters. The time you take to record fish mortality. Over time can be vital if you are seeking insurance. Insurers need to know how your business operates, including losses, under normal circumstances before they will insure your business to cover unusual or out of the ordinary losses.

Figure 96. Paper record sheets



Figure 97. A modern aquaculture management and analysis platform



# SECTION

## **Economics of IPRS**

The purpose and value of the economics section is to provide the reader with a detailed understanding of costs and returns around In-Pond Raceway Systems. Because the manual is applied globally as an advanced pond production technology, we have not tried to provide local details. Readers can find some locally focused information in this section, but more country specific information can be found in Section 8. Of greatest value, here are the interactive business analysis templates provided in this section where anyone using their individual information can generate an accurate financial snapshot of their perspective IPRS business.





## SECTION 7.1: Introduction

In this section, our objective is to bring the elements of IPRS into full focus. The business aspects of IPRS fish production are presented here. This chapter combines the physical IPRS production, receipts and expenses to show the return (profitability) of operations that have implemented IPRS over time. This section provides financial analysis basics and enterprise budget generation that allows readers to insert their local system's investment, operational costs and sales to project net returns or profits. The accompanying spreadsheets show example calculations for the

US, China, Vietnam and Colombia-Mexico-Honduras IPRS experiences. An accompanying Enterprise Budget Generator (EBG) spreadsheet tool can help entrepreneurs make informed business decisions regarding IPRS adoption and operation. **The EBG spreadsheet tool provides instructions** to assist in navigating and completing the investment and depreciation spreadsheet and the area production and economic information spreadsheet, both of which will automatically generate an enterprise budget from your inputs.

Additionally, on the generated enterprise budget spreadsheet, there are options for you to insert sales and cost figures reflecting your local conditions if the automatically

generated budget does not meet your criteria. The EBG can aid those investigating first time evaluation of the IPRS as well as those experienced in operating IPRS.

## SECTION 7.2: Economics of IPRS

Growers considering modifying their farms to adopt the IPRS technology need to understand the economic implications of this approach to commercial aquaculture to be profitable. Successful use of this technology requires appropriate management and sticking to the IPRS principles, construction dimensions and operating guidelines.

Figure 98. Investment and depreciation spreadsheet

Capital Costs	Unit	Cost / Unit	Number	Total cost	% of Total Cost	Years of Use	Salvage value	Depreciation Cost/year	% of Total Depreciation Cost
Land Cost or Land use cost (if purchased enter here, if rented put into '2) Area Prod Econ info' worksheet)	ha	\$ -	1.5	\$ -	0%				
Pond construction	ha	\$ 3,830	1.5	\$ 5,745	6%	20	\$ -	\$ 287	3%
Pond reconfiguration	ha	\$ 2,500	1.5	\$ 3,750	4%	20	\$ -	\$ 188	2%
Water system	each	\$ 1,400	1.0	\$ 1,400	1%	15	\$ -	\$ 93	1%
Utility electricity	each	\$ 500	1.0	\$ 500	0%	15	\$ -	\$ 33	0%
Road reconfiguration	km	\$ 250	3.0	\$ 750	1%	10	\$ -	\$ 75	1%
Feed storage building/facility/bin	each	\$ 500	1.0	\$ 500	0%	10	\$ -	\$ 50	1%
Raceway system components	total	\$ -	0	\$ -	0%	10	\$ -	\$ -	0%
- Raceway WALL construction materials	raceway	\$ 5,000	4.00	\$ 20,000	19%	20	\$ -	\$ 1,000	10%
- Raceway FLOOR construction materials	m3	\$ 300	15.0	\$ 4,500	4%	20	\$ -	\$ 225	2%
- Raceway fish confinement gates	3 per RW	\$ 800	9	\$ 7,200	7%	10	\$ -	\$ 720	7%
- Raceway walkways, front and rear, fixed	2 per RW	\$ 1,500	6	\$ 9,000	9%	10	\$ -	\$ 900	9%
Baffle curtain/fence/earthworks	1 per pond	\$ 500	1	\$ 500	0%	5	\$ -	\$ 100	1%
Waste collection system and associated gear	1 per pond	\$ 3,500	1	\$ 3,500	3%	15	\$ -	\$ 233	2%
- On-shore vessels for receiving solid wastes*	3 per pond	\$ 600	3	\$ 1,800	2%	10	\$ -	\$ 180	2%
- Pumps for getting wastes out of on-shore vessel	each	\$ 500	2.0	\$ 1,000	1%	10	\$ -	\$ 100	1%
- Electrical service for waste collection system	each	\$ 1,000	1.0	\$ 1,000	1%	10	\$ -	\$ 100	1%
Labor Costs (Assembly, Commissioning, and Construction)	each	\$ 2,500	1.0	\$ 2,500	2%				0%
<b>Subtotal Capital Items</b>				\$ 63,645	61%			\$ 4,285	44%
<b>Machinery and Equipment Costs</b>	Unit	Cost / Unit	Number	Total cost	% of Total Cost	Years of Use	Salvage value	Depreciation Cost/year	% of total cost
Feeding equipment	one sum	\$ -	0.0	\$ -	0%	15	0	\$ -	0%
- Scoop/bucket	each	\$ 10	25.0	\$ 250	0%	5	\$ -	\$ 50	1%
- Programmable feeders	each	\$ 1,500	3.0	\$ 4,500	4%	10	\$ -	\$ 450	5%
- Video and surveillance equipment	each	\$ 1,500	3.0	\$ 4,500	4%	10	\$ -	\$ 450	5%
Water chemistry kit/buoy/platform	each	\$ 3,000	2.0	\$ 6,000	6%	10	\$ -	\$ 600	6%
Whitewater units (WWU), minus the blower	per pond	\$ 880	3.0	\$ 2,640	3%	10	\$ -	\$ 264	3%
- Blowers*	each	\$ 1,200	8.0	\$ 9,600	9%	5	\$ -	\$ 1,920	20%
- Spare diffuser tubing and miscellaneous associated items		\$ -	0.0	\$ -	0%	5	\$ -	\$ -	0%
Harvesting gear	each	\$ 2,500	1.0	\$ 2,500	2%	5	\$ -	\$ 500	5%
Fingerling culture equipment	each	\$ 1,500	1.0	\$ 1,500	1%	5	\$ -	\$ 300	3%
Auto-start generator	each	\$ 4,000	1.0	\$ 4,000	4%	10	\$ -	\$ 400	4%
Dissolved oxygen meter	each	\$ 500	2.0	\$ 1,000	1%	10	\$ -	\$ 100	1%
Microscope	each	\$ 500	1.0	\$ 500	0%	10	\$ -	\$ 50	1%
Vehicles	each	\$ 2,500	1.0	\$ 2,500	2%	10	\$ -	\$ 250	3%
Scales	each	\$ 200	4.0	\$ 800	1%	10	\$ -	\$ 80	1%
Miscellaneous tools and hardware		\$ -	0.0	\$ -	0%	1	\$ -	\$ -	0%
Labor Costs (for installation of equipment/machinery items)		\$ 33		\$ -	0%	1	\$ -	\$ -	0%
Other item	each	\$ -	0.0	\$ -	0%	10	\$ -	\$ -	0%
Other item	each	\$ -	0.0	\$ -	0%	10	\$ -	\$ -	0%
<b>Subtotal Machinery and Equipment</b>				\$ 40,290	39%			\$ 5,414	56%
<b>TOTAL</b>				\$ 103,935	100%			\$ 9,699	100%

**Figure 99.** Area production economic information spreadsheet

Economics	Cell # 1	Cell # 2	Cell # 3	
Fish Sales Price	\$ 2.64	\$ 2.20	\$ 1.85	
<b>Input Prices</b>	<b>Cell # 1</b>	<b>Cell # 2</b>	<b>Cell # 3</b>	
Feed #1, per MT	\$ 550	\$ 675	\$ 661	
Feed #2, per MT	\$ -	\$ -	\$ -	
Fingerlings, per each	\$ 0.15	\$ 0.10	\$ 0.42	
Transport of harvested fish, per kg	\$ 0.070	\$ 0.005	\$ 0.070	
Aeration electricity, per WWU month*	\$ 125	\$ 125	\$ 125	
Pond rental, per ha	\$ 250	\$ 250	\$ 250	
<b>RECEIPTS</b>	<b>Cell # 1</b>	<b>Cell # 2</b>	<b>Cell # 3</b>	<b>Total</b>
Fish Sales	\$ 87,120	\$ 60,500	\$ 52,910	\$ 200,530
<b>INPUT COSTS</b>	<b>Cell # 1</b>	<b>Cell # 2</b>	<b>Cell # 3</b>	<b>Total</b>
Feed #1	\$ 27,225	\$ 24,131	\$ 28,735	\$ 80,091
Feed #2	\$ -	\$ -	\$ -	\$ -
Fingerlings	\$ 5,500	\$ 5,556	\$ 5,337	\$ 16,393
Management, actual	\$ 3,116	\$ 749	\$ -	\$ 3,865
Hired Labor, actual	\$ 2,700	\$ 2,174	\$ 1,040	\$ 5,914
Fuel and lubricants for generator, actual	\$ 200	\$ 200	\$ 200	\$ 600
Electricity for WWU*	\$ 2,250	\$ 1,000	\$ 1,350	\$ 4,600
Electricity for RW supplementary aeration*	\$ 563	\$ 250	\$ 338	\$ 1,150
Bird netting or predator protection, actual	\$ 250	\$ 100	\$ -	\$ 350
Chemicals, total, actual	\$ 650	\$ 650	\$ 650	\$ 1,950
Pond rental	\$ 125	\$ 125	\$ 125	\$ 375
Other item can be entered here	\$ -	\$ -	\$ -	\$ -
Other item can be entered here	\$ -	\$ -	\$ -	\$ -
Other item can be entered here	\$ -	\$ -	\$ -	\$ -
Other item can be entered here	\$ -	\$ -	\$ -	\$ -
Other item can be entered here	\$ -	\$ -	\$ -	\$ -
Other item can be entered here	\$ -	\$ -	\$ -	\$ -
Miscellaneous	\$ 200	\$ 200	\$ 200	\$ 600
<b>TOTAL INPUT COSTS</b>	<b>\$ 42,779</b>	<b>\$ 35,135</b>	<b>\$ 37,975</b>	<b>\$ 115,888</b>

**Four economic elements are required to develop measurements of profitability for the IPRS in the EBG.**

1. Initial investment in the IPRS
2. Expenditures related to growing fish
3. Sales revenue brought in through the sale of harvested fish
4. Metrics to measure success and profitability

For those who have little to no experience with IPRS, EBG's default values provide estimates for four fish species (hybrid catfish, grass carp, channel catfish and tilapia). To make the resulting budgets meaningful, updating investments and inputs with current local prices is required.

Inputs are those items that are purchased for the IPRS construction and growth of fish.

For those experienced with IPRS, your records from current and past IPRS grown crops of fish are valuable. They need to be recorded in an orderly fashion, so they can be put to use in the development of enterprise budgets for alternative species, stocking rates or scenarios you would like to know before starting an actual crop.

A brief understanding of enterprise budgets is required to understand the EBG, its output and how to interpret its results.

**The enterprise budget is straightforward and provides a measure of the short-term (income above variable costs) and long-term profitability (net returns or income above combined variable and fixed costs).**

**Figure 100.** Generated enterprise budget spreadsheet

COUNTRY NAME	Cell # 1	Cell # 2	Cell # 3	Total
Enterprise Budget for =====>	Catfish	Tilapia	Grass Carp	
Total Biomass (weight) Initially stocked,	990	1,944	9,658	12,593
Total Biomass (weight) Harvested	33,000	27,500	28,600	89,100
Total Investment Cost of Your System				103,935
<b>RECEIPTS</b>	<b>Cell # 1</b>	<b>Cell # 2</b>	<b>Cell # 3</b>	<b>Total</b>
Fish Sales	\$ 87,120	\$ 60,500	\$ 52,910	\$ 200,530
<b>INPUT COSTS</b>				
Feed #1	\$ 27,225	\$ 24,131	\$ 28,735	\$ 80,091
Feed #2	\$ -	\$ -	\$ -	\$ -
Fingerlings	\$ 5,500	\$ 5,556	\$ 5,337	\$ 16,393
Management, actual	\$ 3,116	\$ 749	\$ -	\$ 3,865
Hired Labor, actual	\$ 2,700	\$ 2,174	\$ 1,040	\$ 5,914
Fuel and lubricants for generator, actual	\$ 200	\$ 200	\$ 200	\$ 600
Electricity for WWU*	\$ 2,250	\$ 1,000	\$ 1,350	\$ 4,600
Electricity for RW supplementary aeration	\$ 563	\$ 250	\$ 338	\$ 1,150
Bird netting or predator protection, actual	\$ 250	\$ 100	\$ -	\$ 350
Chemicals, total, actual	\$ 650	\$ 650	\$ 650	\$ 1,950
Pond rental	\$ 125	\$ 125	\$ 125	\$ 375
Other item can be entered here	\$ -	\$ -	\$ -	\$ -
Other item can be entered here	\$ -	\$ -	\$ -	\$ -
Other item can be entered here	\$ -	\$ -	\$ -	\$ -
Other item can be entered here	\$ -	\$ -	\$ -	\$ -
Other item can be entered here	\$ -	\$ -	\$ -	\$ -
Other item can be entered here	\$ -	\$ -	\$ -	\$ -
Miscellaneous	\$ 200	\$ 200	\$ 200	\$ 600
<b>TOTAL INPUT COSTS</b>	<b>\$ 42,779</b>	<b>\$ 35,135</b>	<b>\$ 37,975</b>	<b>\$ 115,888</b>
<b>INCOME ABOVE VARIABLE COSTS</b>	<b>\$ 44,342</b>	<b>\$ 25,365</b>	<b>\$ 14,935</b>	<b>\$ 84,642</b>
<b>FIXED COSTS</b>				
Depreciation on Capital Items	\$ 1,428	\$ 1,428	\$ 1,428	\$ 4,285
Depreciation on Machinery and Equipm	\$ 1,805	\$ 1,805	\$ 1,805	\$ 5,414
<b>TOTAL DEPRECIATION</b>	<b>\$ 3,233</b>	<b>\$ 3,233</b>	<b>\$ 3,233</b>	<b>\$ 9,699</b>
<b>TOTAL COSTS</b>	<b>\$ 46,011</b>	<b>\$ 38,368</b>	<b>\$ 41,208</b>	<b>\$ 125,587</b>
<b>NET RETURN (Net Income)</b>	<b>\$ 41,109</b>	<b>\$ 22,132</b>	<b>\$ 11,702</b>	<b>\$ 74,943</b>
ROI	40%	21%	11%	24%
Cost per kg of fish harvested	\$ 1.39	\$ 1.40	\$ 1.44	\$ 1.41
Cost per unit gain	\$ 1.44	\$ 1.50	\$ 2.18	\$ 1.70
Payback period, years				1.4

Several indicators of profitability can be calculated once the enterprise budget has been generated:

- **Net return** – includes all costs and is calculated by subtracting all costs from the sales receipts.
- **Cost of producing a unit of fish (1 kg, 1 lb, 1 unit)** – calculated by dividing total costs by kilograms produced. This calculated cost of production allows quick comparison to the sales price to know if one is making money (profit) or not and by how much.
- **Return on investment (ROI)** – calculated by dividing net returns by initial investment (x 100 to make it a percent). This is a good measure of the IPRS performance, and its ability to repay the initial investment.
- **Payback period** – in years, can be calculated by dividing the initial investment by the annual net return projected from the IPRS.

These measures are automatically calculated in the EBG once your investment and operating spreadsheets are completed for your specific IPRS unit and pond volume.

## SECTION 7.3: Investment and Construction Costs

Initial investments will vary with the current situation of the entity investigating construction of an IPRS unit. For those already operating an aquaculture operation, they would begin with pond and road reconfiguration costs, if needed. Others who do not presently have existing aquaculture operations would have initial investments in land acquisition/rental, pond construction, installation of water and electrical systems. Additionally, machinery and equipment items need to be purchased. These items would include feed storage bins, buildings, shelters, feeding equipment, water chemistry kits, WWUs, harvesting gear, fingerling culture equipment, generators, dissolved oxygen meters, microscope, vehicles and alarm systems. Depending on the size and scope of your operation, all or part of this list of items will be needed.

IPRS investment item cost require knowledge of the IPRS component parts which have been laid out in the prior sections of this manual. Each country and region where an IPRS is constructed will have different local building materials available and this will affect the costs. Costs for each of these items will need to be entered into the Investment and Depreciation worksheet within the EBG spreadsheet, though there are default values listed as an initial guide. The standard USSEC IPRS 3-cell

raceway (RW) system's dimensions are 5m wide x 30m long x 2.3m deep. This 30 m RW length is divided into 2m for the WWU placement, 22m for the production growing area (PZ) and 6 m for the quiescent zone (QZ). Raceways share common walls and other electrical control gear.

A full expense list of the IPRS module components and required equipment, supplies, transport and labor of the construction needs to be conducted by the investor during the planning phase. Such a list can be found in the EBG Investment and Depreciation example spreadsheet for the U.S., China, Vietnam and Colombia-Mexico-Honduras, and can be used as a starting point and guide. Many items included in that list may or may not be required for your specific operation. Additionally, you may need other components or equipment that are not listed and the EBG allows you to enter them. You should consult with your USSEC Aquaculture Team Representative to adapt this list for your location and scale of operation.

**Visit [www.ussec.org/iprs](http://www.ussec.org/iprs)  
for the U.S. EBG spreadsheet.**

In 2020, a representative 3-cell IPRS for the U.S., initial investment was \$20,000-\$30,000 for the basic IPRS components, plus \$14,000 for associated machinery and equipment costs. This excludes construction item transport and labor costs, which could be substantial depending on your locality. In the case where no aquaculture operation existed previously, the initial investment includes land purchase, pond construction, pond reconfiguration, water system, utility electricity, road reconfiguration, feed storage or bin, baffle curtain, waste collection system and associated gear.

This makes for another \$24,000 in investment required, bringing the total capital investment to \$64,700. When the full accoutrement of equipment investment includes feeding equipment, water chemistry kits, WWUs, blowers, harvesting gear, fingerling culture equipment, auto-start generator, dissolved oxygen meters, microscope and scales, another \$37,800 is required. This brings the initial investment for capital items, machinery and equipment to \$102,500. Note, this will vary from location to location and from farm to farm.

**Visit [www.ussec.org/iprs](http://www.ussec.org/iprs)  
for the China EBG spreadsheet.**

In a representative 3-cell system for China, initial investment was approximately \$33,015 for pond reconfiguration, utility changes, feed storage bins, raceway system components (walls, floor, confinement gates and walkways), baffle curtain, waste collection system and labor to construct. Another \$15,430 was invested in machinery and equipment (automatic feeders, whitewater units, harvesting gear, auto-start generator, dissolved oxygen meter, bottom aeration unit and labor to install these items. In total, initial investment was approximately \$48,445. Note, this will vary from location to location and from farm to farm. The costs here were calculated from building anew.

**Visit [www.ussec.org/iprs](http://www.ussec.org/iprs)  
for the Vietnam EBG spreadsheet.**

In a representative 3-cell IPRS for Vietnam, initial investment for land, pond/road modifications, water/utility modifications, feed storage, raceway system components, baffle fence, waste collection system and



labor were approximately \$30,000. Investment for machinery and equipment items was approximately \$20,000 for feeding machinery, camera and surveillance equipment, water quality meter, blowers, spare diffuser tubing, harvesting gear, auto-start generator, dissolved oxygen meter, scales and installation labor. This brings the total initial investment to approximately \$50,000. Note, this will vary from location to location and from farm to farm.

Visit [www.ussec.org/iprs](http://www.ussec.org/iprs) for the Latin America EBG spreadsheet.

In a representative 3-cell IPRS for Latin America, initial investment was approximately \$74,000. This is high because the scenario begins with no aquaculture operation at all. The investment begins with the purchase of land, construction of the pond, reconfiguring the road and installing an artisanal well. Also, purchasing and installing a feed storage building, raceway system components, baffle curtain and waste collection system and associated onshore vessel, pumps and electrical service are all costly. Additionally, initial machinery and equipment investment was approximately \$19,000. This included items needed to start up an aquaculture operation, including water chemistry buoys/platform, WWU units, blowers, harvesting gear, generator, dissolved oxygen meter and scales. This brings the total initial investment to \$93,000. Note, this will vary from location to location and from farm to farm.

For more information about IPRS, contact [IPRS@ussec.org](mailto:IPRS@ussec.org).

## SECTION 7.4: Variable Costs

Variable costs are those occurring during the production process and are also called operating costs. These include expenditures for fingerlings, feed, labor, electricity, chemicals and other items needing to be purchased so fish production can occur. Feed costs are typically 40% – 75% of total variable costs, followed in importance by fingerlings (9% – 49%), electricity (4% – 6%) and management/labor (3% – 13%), though this depends on your location and an item's supply availability.

Operating costs from the U.S. pilot IPRS crops conducted in Alabama (Chappell, Hanson, Bott, Roy, et al.) showed the efficiency of fish production through the calculated low feed conversion ratios (FCR) achieved. Thus, low FCR is the first striking feature of IPRS fish production. FCR is the feed fed divided by the fish weight grown (gained). The FCR is the feed fed divided by the weight gained, that is simply, 1.5 kg of feed is used to produce 1.0 kg of weight gained. In the Auburn trial, FRC ranged from 1.5:1 to 1.8:1 depending on species cultured (channel catfish or hybrid catfish).

Comparatively, FCR from pond-raised catfish production typically ranges currently from 2.0 to 3.0 each. Traditionally managed ponds typically achieve survivorship of <60% survival. Disease, avian predators as well as fish on fish predation reduce survival typically to below 55%. The second striking feature from these IPRS studies was the high survival (88% – 98%), but survival could also be much lower (47% – 69%) when disease outbreaks occurred and were not promptly addressed.

However, even with lower survival, FCR was still very good. Third, production yields from raceway studies with catfish at Auburn University have shown 16,237 kg/ha can be grown.

### Hybrid Catfish (US):

In a representative 3-RW IPRS producing hybrid catfish in the U.S., variable cost for two protein levels of feed, fingerlings, labor/management, fuel/lubricants, electricity (for WWUs, RW supplementary aeration and meter charges), bird netting/predator control, chemicals, transport of harvested fish, repairs and maintenance and miscellaneous items was approximately \$46,903 per cell (x 3 cells = \$140,709). The two feeds represented 64% of total variable costs. Management/labor costs represented 13% of all operating costs, while fingerlings represented 9%, electricity 6%, transport of harvested fish 5%, chemicals 1% and repairs/maintenance 1%. These inputs produced 99,000 kg of harvested fish (3 cells x 33,000 kg/cell), achieved a cell yield of 150 kg/m<sup>3</sup> and had an FCR or 1.5 and a survival rate of 90%.

### Grass Carp (China):

In a representative 3-RW IPRS producing grass carp in China, variable costs for feed, fingerlings, labor, fuel/lubricants, electricity (for WWU and RW supplementary aeration), chemicals, pond rental and miscellaneous were approximately \$26,301 per cell (x 3 cells = \$78,903). Feed represented 52% of all costs and fingerlings represented 14% of these costs. Electricity (3%), labor (3%), chemicals (<1%) and fuel / miscellaneous represented smaller portions of the operating expenses. These inputs produced 82,578 kg (3 cells x 27,526 kg/cell), achieved a cell yield of 147 kg/m<sup>3</sup>, had an FCR of 1.52 and a 96.8% survival rate.

### **Channel Catfish (Vietnam):**

In a representative 2-RW IPRS for Vietnam growing channel catfish, total variable costs were \$71,500 to produce 44,880 kg of channel catfish were produced (2 RW cells x 22,440 kg/cell). The percent of total variable cost represented by fingerling expenditures was 49% and was greater than the feed expenditure portion (41%) or all variable costs. Electricity expenses represented 5% of all variable costs, while management (3%) and labor (1%) expenses were less. Probiotic expenses were 1% of variable costs. Using only two of the three RW cells of an IPRS, a cell yield of 102 kg/m<sup>3</sup> was achieved, FCR was 1.60, and there was a 90% survival rate.

### **Tilapia (Colombia-Mexico-Honduras):**

In a representative 3-RW IPRS for Colombia-Mexico-Honduras growing tilapia, total variable costs were \$49,050 to produce 35,067 kg of tilapia (3 RW cells x 11,689 kg/cell). Feed expenditures were 64% of this total. Note, two feeds were used, a higher priced 35% crude protein feed (\$720 / mt) that represented 25% of all feed fed and a 32% crude protein feed (\$675 / mt) that made up the remaining 75% of feed fed. Fingerlings represented 15% of variable costs, followed by management/labor (8%), electricity for WWU (6%), tilapia vaccines (5%) and repairs/maintenance (1%). From the three cells, an average cell yield of 53 kg/m<sup>3</sup> was achieved, with an FCR of 1.30 and a survival rate of 85%.

## **SECTION 7.5: Fixed Costs**

Fixed costs are those that an operation incurs whether fish are produced or not. Typically, fixed costs are comprised of depreciation, interest on loans (for purchase of land, pond construction, equipment and machinery) and repairs and maintenance on capital machinery equipment items, taxes and insurance. The major fixed cost is depreciation, which accounts for the cost or value lost from these items due to the wear and tear on them (capital, equipment and machinery) due to the fish production cycle. In the IPRS enterprise budget generator (EBG) spreadsheet depreciation is the proxy for all fixed costs.

In the U.S. example, annual depreciation totaled \$3,066 per cell or \$9,198 for the three cells and was 8.5% of all costs. In the China example, annual depreciation for a representative 3-RW IPRS was \$28,068 (3 cells x \$9,356/cell) or 26% of all costs. In the Vietnamese channel catfish 2-RW cell example, depreciation totaled \$7,186 or 9.1% and, in the Colombia-Mexico-Honduras tilapia 3-RW cell example, depreciation totaled \$6,940 or 14.6%. Differences in fixed cost totals are due to the cost of individual items and their associated expected useful life. For instance, a pond reconfiguration is expensive, say \$5,000, but when its expected life is 20 years, the annual depreciation is \$250, whereas \$3,500 spent on nine raceway fish confinement gates and an economic life of 10 years results in annual depreciation of \$350. Note, that the EBG has a default of \$0 salvage value for all items. If salvage values were used, they would be subtracted from the total cost before dividing that by the economic life.

Another difference in annual depreciation costs was the number of capital good items and machinery-equipment items listed in the investment and depreciation spreadsheet of the EBG. In the China example, there are 11 capital cost items and 7 machinery-equipment items. In the Vietnam example, there are 15 capital cost items and 10 machinery-equipment items. In the Colombia-Mexico-Honduras example, there are 13 capital cost items (including pond construction that was not included in the China case and included as pond bottom mud removal, dike repair and improving the bottom condition of a fish pond) and 7 machinery-equipment items. Thus, the number of items, their cost and associated economic life have varying influences on the total annual depreciation charge used in the enterprise budget.

## **SECTION 7.6: Sales, Net Returns and Other Measures of Profitability**

### **Fish Sales (Revenue)**

Fish sales or revenue come from selling the fish quantity raised and harvested in the IPRS and sold at one or more price points. The sales price depends on the species raised, the buyer's willingness to pay, seasonality and market channel level fish are being sold, that is to individuals, wholesalers, processors, grocery stores, restaurants, etc. In the U.S. 3-RW IPRS example, 1 kg Hybrid Catfish were sold at \$2.86 / kg, total production sold was 99,000 kg = \$283,140 in sales. In the China 3-RW example, 2.4 kg Grass Carp sold for \$1.86/kg, total production sold was 82,578 kg (3 cells x 27,526 kg/cell) x \$1.86/kg = \$153,595 in sales (or \$51,198/ cell x 3 cells).

In the Vietnam 2-RW example, 2.5 kg channel catfish sold for \$2.39 / kg, total production sold was 44,880 kg = \$107,263. And, in the Colombia-Mexico-Honduras 3-RW example, 0.55 kg tilapia sold at \$2.20 / kg, total production sold was 35,066 kg = \$77,145.

### Net Return

When variable and fixed costs are summed, you have total costs. When this is subtracted from fish sale receipts, you have the net return. The net return is often referred to as the profit from a crop of fish. It is the money left over after all costs have been paid for that the owner reaps as their reward for the operation. We focus on the net return as a measurement of profitability. Total net returns for the U.S. 3-RW example were \$175,447 or \$58,482 per RW cell; for the China 3-RW IPRS example was \$46,628 or \$15,542 per RW cell; for Vietnamese 2-RW cell was \$30,105 or \$15,052 per RW cell; and for Colombia-Mexico-Honduras 3-RW cell was \$55,987 or \$18,662 per RW cell.

### Cost Per Kilogram Produced

A third important measure of profitability is the cost to produce fish in the IPRS. The cost of production is calculated by dividing the total cost by the weight of the fish produced. This will give a monetary value to produce one weight unit of fish, such as \$/kg. When compared to the selling price for a weight unit of fish, one can quickly see how much gain (or loss) occurs for every unit of fish sold.

The cost per kilogram of hybrid catfish harvested in the U.S. example was \$1.09/kg and compared to the selling price of \$2.86/kg, representing a \$1.77 profit per kg produced. In the China example, the cost of production was \$1.30/kg and the selling price was \$1.86/kg, indicating there was a \$0.56/kg

profit per kg of grass carp produced. In the Vietnamese example, the cost of production was \$1.70/kg and compared to the selling price of \$2.39/kg, there was a \$0.69/kg profit per kg of channel catfish produced. In the Colombia-Mexico-Honduras example, the cost of production was \$1.60/kg and compared to the selling price of \$2.20/kg, there was a \$0.60/kg profit for every kg of tilapia produced.

### Return on Investment (ROI)

Another important indicator of profitability is the return on investment (ROI) which is calculated by dividing the net return by the initial investment. The ROI is presented as a percentage and indicates what proportion the net return is to the initial investment. The higher the ROI the better is the profitability.

**The ROI for the U.S., China, Vietnamese, Colombia-Mexico-Honduras examples were 57%, 32%, 30% and 8%, respectively.**

Remember, the IPRS is an advanced pond aquaculture production technology that carries with it a significant investment. All of your fixed costs and major portions of variable costs will be incurred whether you produce any fish or not. To cover these costs, it is to the investor/operator's advantage to plan and operate the system to produce yields well above those typical in traditionally managed ponds. IPRS operated according to principles we teach allow you to do this with less risk.

### Payback Period

The payback period is the time, in years, that it will take to pay off the initial investment.

To calculate this, the initial investment is divided by the annual net return. This supposes the net return will be the same each year, so if it varies from year to year the payback period will vary as well. The payback period for the U.S., China, Vietnamese, Colombia-Mexico-Honduras examples were 0.6, 1.0, 1.7, and 4.4 years, respectively.

## SECTION 7.7: Marketing

Marketing results in sales. Selling your product is simple if you have buyers dedicated to buying all you can produce. However, if you produce large quantities of fish, you may be limited to those who can purchase large quantities. Selling large quantities often results in lower prices per kg sold. On the other hand, if you can sell to numerous buyers, who in total want more fish than you harvest at one time, they may be willing to pay more per kg to ensure they obtain the fish quantity they need to satisfy their customers. IPRS operators are seldom in control of prices offered by buyers. When supplies of particular fish are abundant, prices typically decline and vice versa. So, it is to the operators' advantage to be well aware of market conditions in advance of selling their fish. As a hedge against seasonal or cyclical price declines, some operators diversify the species they produce and also avoid selling during periods of seasonal abundance in favor of selling year round. Multiple IPRS cells producing a variety of species can reduce risk associated with seasonal over-abundance.

Buyers can be grouped into categories, such as wholesalers, middlemen, retail and individuals. Wholesalers buy direct from the fish production source and redistribute their purchase to other buyers.



Middlemen buy from the source or from wholesalers and then sell the product to others, but they never intend to own the fish for long, as their business is moving the fish along to others. Retail buyers may not buy directly from the fish production source, but they buy from wholesalers or middlemen. They then sell the product to end user customers that could be individuals or restaurateurs. Individuals usually do not buy from the fish production source and typically buy from retailers. These buyer categories change by county, rural-urban areas, etc.

## SECTION 7.8: Advanced Aquaculture with IPRS

Fish in raceways and open pond-segregated polyculture IPRS are an advanced form of pond aquaculture which combines culture of fish in confinement with robust flowing water to achieve an accelerated rate of waste assimilation. To reliably and predictably operate at the production levels attributed to IPRS, operational principles must be followed. These include collection and removal of settled solid waste and utilizing service species or filter feeders to assist in managing the waste load from feeding fish. In past cage culture trials, and more recently in IPRS trials supported by USSEC, a concept termed 80:20 has been used successfully by growers.

This concept is practiced by growers who feed fish in cages or raceways but stock service species in the open water where they are not fed and are allowed to forage on naturally occurring biota. This biomass is enhanced by aggressive feeding. Utilizing this approach, the grower

can harvest a primary “fed crop” as well as a crop of service species. In this kind of segregated polyculture, service species might be fish like silver or bighead carps, mono-sex (male) tilapia, shrimp, bivalves and so forth.

The biomass yield of the service species will approximate 20%-25% of the fed fish weight. By this means, the farm is able to monetize more fully the feed investment made to the fed fish crop. Depending upon which service species is used, the economic return on investment can be significant. This element in the production plan needs management and care to return optimal revenue to the farm.

## SECTION 7.9: Aquaponics

Aquaponics is a form of aquaculture which combines culture of fish with that of plants where one part of the system nourishes the next. Most often, it is conceptually designed and operated as a kind of “closed system” where nutrient concentrations from fish excreta are relatively high. In IPRS, a parallel approach to aquaponics has been tried with poor results to date.

Fish are cultured in confinement allowing collection and removal of solids, which are passively settled in a quiescent zone (QZ) immediately downstream of the raceway Production Zone (PZ).

However, in IPRS, the largest fraction of waste released by fish is in gaseous and liquid forms which are difficult to collect directly, hence, we use service species which graze upon the biota produced in the pond environment by abundant excreted nutrients. **The opportunity in utilizing the directly harvested settled solids is currently**

### considered in three areas:

- Harvested solid slurries can be used in land application for crops such as rice, lotus, coconut, oil palms, terrestrial grains, forage grasses, corn, vegetables, etc. The material in liquid form is heavy and costly to transport so nearby destinations are important. At one facility in Egypt, the waste solids are laid out to dry and the neighboring community of people is invited to take it home to use in their gardens. This effectively eliminates the need to transport, and it increases the goodwill in the community and could lead to testimonials.
- Heavily aerated “tea” made from agitated slurry is an effective fertilizer for a broad range of food and ornamental plants. Similarly, this nutrient rich liquid can be used to “fertigate” plant types listed above.
- On IPRS facilities, particularly those with numerous cells, settled solids can be digested to efficiently produce biogas (methane). Biogas in small and large volumes has numerous uses in rural settings. Biogas can also be dangerous, so seek expertise and exercise care when developing and utilizing it. Each of these uses of production waste or by-products can provide additional revenue and improve ROI.

## SECTION 7.10: Polyculture and Other Revenue

As previously discussed, other revenue streams are possible with the IPRS, including sales of the filtering/service species from open pond and the collected solid wastes from the QZ.

# SECTION

# 8

## Case Studies

The aim of the Case Studies section is to provide the reader with up-to-date information around IPRS in several regions of the world. This information includes a description of the aquaculture business climate as well as information gathered from USSEC supported IPRS trials. The trials provide species specific information useful to those considering adoption of the IPRS approach to pond aquaculture. It is worthy of note that the trial information and data presented here are from farms with only one or two cycles of experience. We expect them to see improving results as they gain experience as long as the IPRS principles are followed.

Partial funding for these feeding projects was provided by the United Soybean Board.

# SECTION 8.1:

## Case Study: Tilapia (Latin America)

# Aquaculture Situation and Case Studies in Latin America

**Report Preparation Date:** 2021,  
 Trial data 2019-2020

**Author:** Mr. Esau Arana

**Location:** Mexico and Honduras

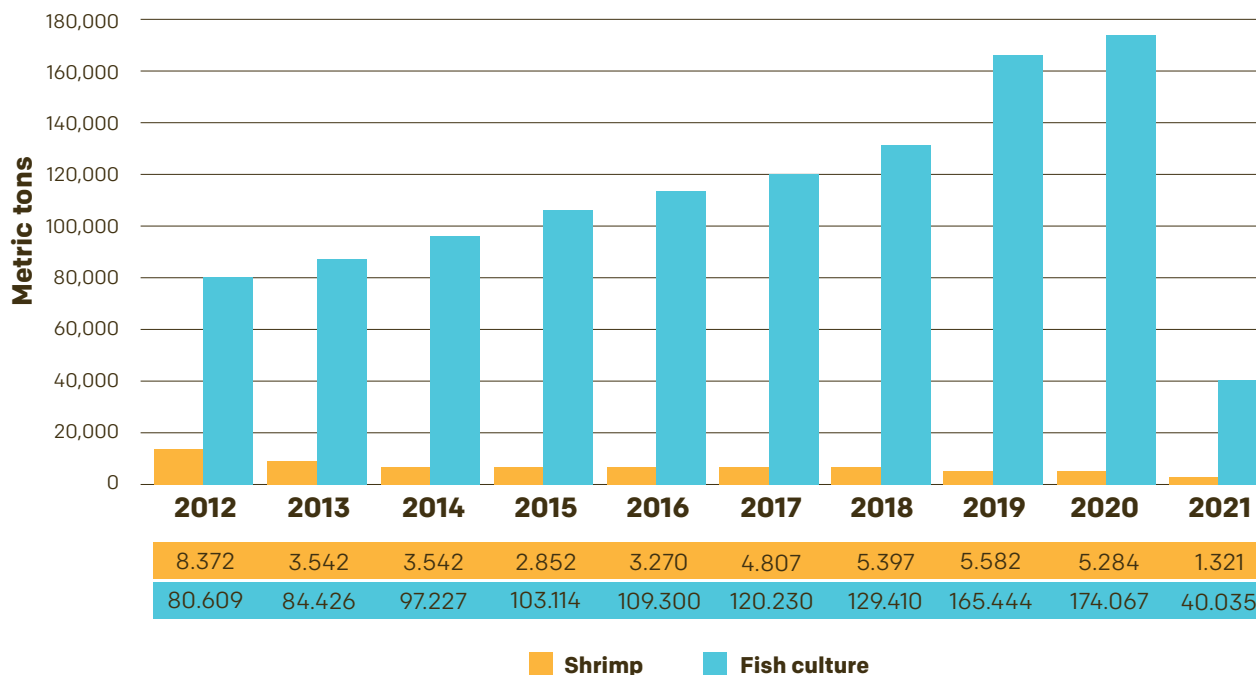
### Introduction

Within the Latin American region, the focus is on the culture of Nile tilapia, *Oreochromis niloticus*, the predominant species cultured there. Although *O. niloticus* is also produced in Brazil, Honduras (red tilapia), Costa Rica and many other countries, this report focuses on Mexico and Colombia only. Colombia alone produced a total of 125,037 metric tons of aquaculture products (several species including marine shrimp), 80,000 metric tons are

*O. niloticus*, equivalent to 58% of the country production, (FAO Fish Stat 2018). Some aquaculture species such as rainbow trout (*Oncorhynchus mykiss*), cultured on the highland elevations where they have cold water resources, and others from the Amazon region, are emerging in controlled farmed production with significant market value. These species include: Cachama: dark (*Colosoma macropomum*), silver (*Piaractus brachypomus*) and Bocachico (*Prochilodus magdalenae*).

In general terms, Colombia freshwater aquaculture production is increasing 10.04% yearly. About 22% of total production is exported to the U.S. and Europe. Twenty-two aquaculture farms and 10 fingerlings production farms are currently Best Aquaculture Practices (BAP) certified, and 16 fish processing plants are Hazard Analysis and Critical Point (HACCP) certified (INVIMA 2020). Colombians also consume 8.8 kg/per capita/year of fish, (FEDAVI).

**Figure 101.**

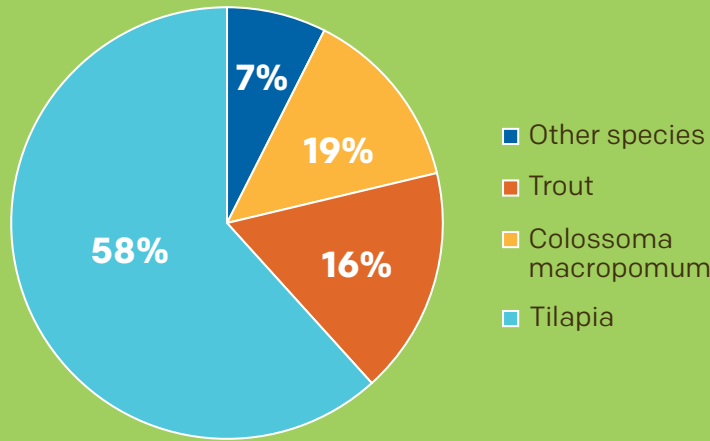


Source: Series Piscicultura 2011 – 2012 Encuesta Nacional Piscícola. MADR – CCI.  
 Series Piscicultura 2013 Encuesta Nacional Piscícola, MADR – Crece – FEDERACAFE.  
 Series Piscicultura 2014 – 2020 Estimaciones Secretaría Técnica Nacional Cadena de la Acuicultura – MADR, con base en información regional.  
 Series Camarón 2011 – 2020, CENIACUA-ACUANNAL.  
 Producción 2021: cifras con corte a marzo



**Figure 102.**

**Fish culture production by species year 2020**



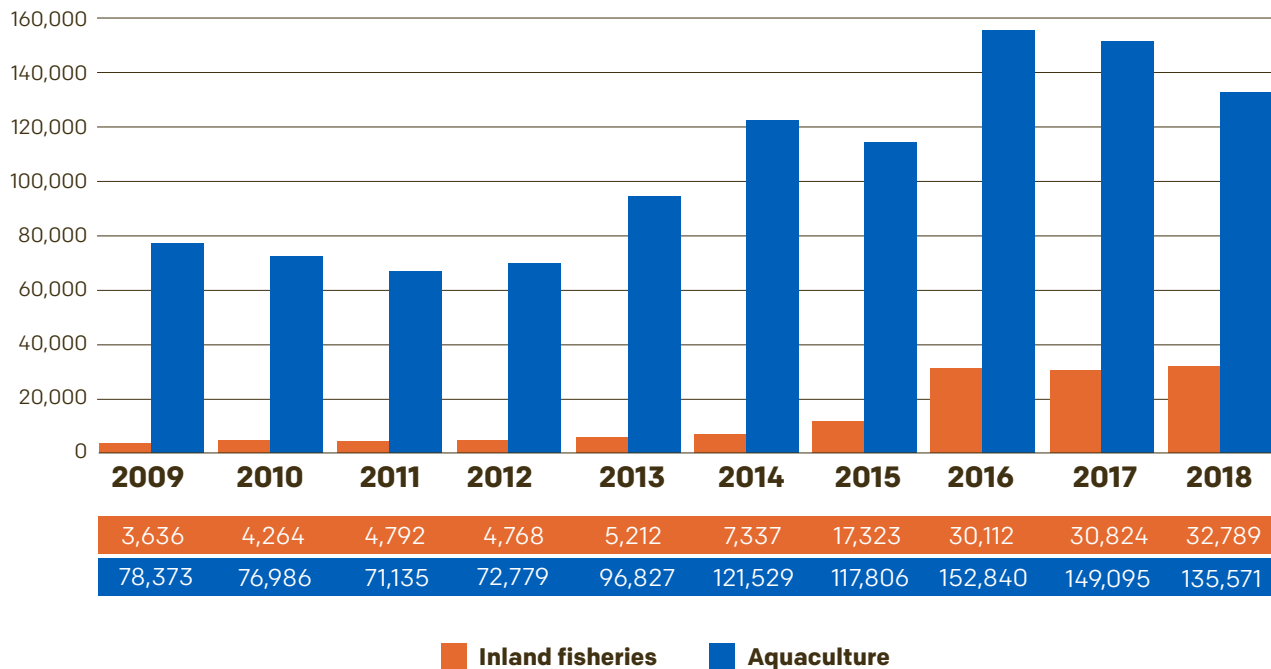
Source: Series Piscicultura 2011 – 2012 Encuesta Nacional Piscícola. MADR – CCI.  
 Series Piscicultura 2013 Encuesta Nacional Piscícola, MADR – Crece – FEDERACAFE.  
 Series Piscicultura 2014 – 2020 Estimaciones Secretaría Técnica  
 Nacional Cadena de la Acuicultura – MADR, con base en información regional.  
 Series Camarón 2011 – 2020, CENIACUA-ACUANNAL.  
 Producción 2021: cifras con corte a marzo

Mexico, according to FAO for 2018, reports around 240,000 metric tons of aquaculture products, 135,571 metric tons are from tilapia (*O. niloticus*, equivalent to 56.5% of the total product volume. Mexico aquaculture products have increased volume at a rate of 9.08% per year.

Mexico includes within the aquaculture production volume data, actual wild caught tilapia harvested by artisanal fishermen from lakes and reservoirs because the origin of these tilapia as fingerlings are from aquaculture tilapia hatcheries. Although the growth of these stocks are extensive and not in traditional ponds, these fish comprise 24.1% of the 135,571 MT (56.5%) of total freshwater aquaculture production.

**Figure 103.**

**Tilapia**



Source: Anuario Estadístico de Pesca y Acuicultura 2018

Mexico has a huge variety of climates and ecosystems, ranging from rainforest to desert, as well as elevations ranging from sea level to 3,500 meters, but Mexico ranges in latitude from 14 to 32 degrees north. Even though lands are at low elevation near the Atlantic coast, especially on the states around Gulf of Mexico (Yucatan, Campeche, Tabasco, Quintana Roo, North of State of Chiapas and Veracruz) temperatures still decline to 21C during the months of December and January. Further south, temperatures increase on average while more northerly locations experience lower temperatures. Tilapia growth is not greatly hindered during winter, but the effect on the production is noticeable. This is not the case in Colombia where water temperatures at locations within

the lower elevation valleys of the country, are suitable for tilapia culture year around.

In Latin America, the tilapia market is very well developed. There are two different markets that tilapia producers are aiming for: domestic and international. The domestic tilapia market also differs among Latin American countries. In Mexico and Colombia, domestic consumers prefer tilapia between 500 to 550 grams per fish, while Central Americans prefer tilapia between 270 to 350 grams per fish.

International markets for tilapia from the region prefer fish between 800 to 1,300 grams per fish since these fish are largely destined for fresh fillets consumers in U.S. and Europe markets. Because consumers and market preferences dictate fish

target weights and production is closely correlated to stocking rates, IPRS stocking rates should closely follow recommendations for stocking rates for IPRS in this manual. IPRS stocking rates (density) will be compared and contrasted with traditional pond stocking later in this chapter.

**Tilapia growth is not greatly hindered during winter, but the effect on the production is noticeable.**

## Study Case 1: In-Pond Raceways System (IPRS) Experiences with Tilapia Nilotica in Campeche, Mexico

### Introduction

Over the last 15 years, Latin America has been introduced, and has entered, the international tilapia market space. Competition among the fish in Latin American countries seems sharper daily. Increased requirements for product quality, various certifications, quality control and sanitation are ongoing. Exporting fish products into the U.S. requires inspections by USDA and FDA, especially as it relates to the presence of antibiotics. American and European consumers are paying attention to product quality and select fish products certified with "sustainability" and "environmentally friendly" labels. The IPRS technology allows fish production of a very high quality and accomplishes these certification requirements.

### Trial Protocols

This trial was conducted at the first IPRS built in Latin America in a 2.6 ha pond with an average depth of 1.8 m. It was constructed without USSEC technical advice. After the project construction was initiated, technical assistance was provided by USSEC. The objectives of this trial were to standardize IPRS protocols with Nile tilapia, optimize days of culture across three harvest cycles per year instead of only two which is typical in traditionally managed ponds. The production target weight was 0.550 to 0.600 kg. Seven standard commercial tilapia raceways were installed in this pond. Each raceway cell WhiteWater Unit (WWU) was equipped with a single 2.12 HP regenerative blower.

A second WWU was installed per each raceway, and existing paddlewheels and aerators were used to help move, mix and aerate water in the open pond. Stocking data is provided in the following table. Fish were monitored by sampling every 14 days, data on dissolved oxygen, temperature, Total Ammonia Nitrogen (TAN), nitrite, alkalinity, hardness and estimated production costs were collected.

Figure 104.

1st Cycle	IPA 1	IPA 2	IPA 3	IPA 4	IPA 5	IPA 6	IPA 7
Stocking dates	28-Aug	25-Aug	25-Aug	21-Jul	7-Sep	7-Sep	16-Sep
Fish stocked	17,122	16,684	17,002	8,050	17,304	17,366	18,674
Initial weight (g)	17.2	18.8	18.8	35	19.03	13.1	13.4
Biomass (kg)	294.50	313.66	319.64	281.75	329.30	227.49	250.23
Density # fish/m <sup>3</sup>	110	107	109	52	111	111	120
Density kg/m <sup>3</sup>	1.89	2.01	2.05	1.81	2.11	1.46	1.60

### Trial Results

Dissolved oxygen was maintained above 2.0 mg/L across all seven raceways, TAN was never more than 2.0 mg/L and nitrites were not detected. Alkalinity was measured at 175 mg/L with total hardness at 530 mg/L. Water temperature was steadily above 26C, declining only in the early morning hours. Average fish weight at harvest was 553 grams, average total harvest biomass was 6,734 kg/raceway after 121 days. Raceways 3 and

4 were considered outliers since Raceway 4 was stocked with only 8,050 fingerlings and Raceway 3 experienced a mortality event of 57% due to human error. However, even with these mistakes, yield per cycle still averaged an annual projection of 54,391 kg/ha/year compared with traditional pond yield of 39,786 kg/ha/year. Feed offering and intake was held to a maximum of only 250 kg/ha/D and feed offering was reduced to 175 kg/ha/D during the last month of feeding.

Consequently, the weight gained per day before this feed reduction decreased from 8.5 g/D to only 2.5 g/D, thereby reducing the overall mean to 4.4 g/D for daily weight gain. This first production trial yielded an ROI of 38.6% compared with traditional pond culture ROI in this area of 22.83%. Average production in this trial is the lowest of all trials. This trial showed three production/harvest cycles per year can be achieved, instead of two typical in traditional ponds.

Figure 105.

	RW-4	RW-3	RW-2	RW-1	RW-5	RW-6	RW-7	AVG	POND
Vol, m <sup>3</sup>	150							RW	148
Days	110	110	116	115	132	122	131	121	64,748
Initial number	8,050	17,002	16,684	17,122	17,304	17,366	14,609	100,087	41,223
Final number	6,791	7,361	15,350	15,182	13,550	14,358	11,996	77,797	66
Surv %	84	43	92	89	78	83	82	81	10
Initial weight, g	35	18.8	18.8	17.2	17.7	13.1	14.1	17	550
Final weight, g	612	550	580	525	645	510	500	553	550
Initial biomass, kg	282	320	314	294	306	227	206	319	647
Final biomass, kg	4,153	4,049	8,906	7,971	8,740	7,323	5,998	6,734	22,673
FCR	1.49	1.33	1.21	1.42	1.34	1.31	1.42	1.34	1.35
Final density, kg	28	27	59	53	58	49	40	50	2.0
AWD, g	5.2	4.8	4.8	4.42	4.75	4.07	3.71	4.4	3.65
<b>Pond-Px kg/Ha/year</b>								<b>54,391</b>	<b>39,786</b>
<b>ROI</b>								<b>38.60%</b>	<b>22.80%</b>



### Summary and Conclusion

- This was the first In-Pond Raceways System (IPRS) demonstration conducted in the Americas with Nile tilapia (*Oreochromis niloticus*).
- The IPRS was designed to conserve water over several years, instead of following traditional pond management protocols where total harvest requires draining the ponds, drying and refilling, therefore losing valuable production time.
- The trial pond was empty for IPRS construction, and at the time just before the pond was flooded, the heavy volume of terrestrial grass that had grown on the pond bottom was cut. This large volume of organic matter was left to decay on the pond bottom. This organic material acted as fertilizer for the muskgrass (*Chara*

sp.), a noxious aquatic weed.

The muskgrass (*Chara*) later completely covered the pond bottom and grew to the surface in places around the pond. Due to the presence of muskgrass, circulation and mixing of water was drastically curtailed and it was essential to eliminate this aquatic weed using the registered herbicide Diuron. This action killed the target weed and as the breakdown of the plant matter took place, it predictably caused depletion of dissolved oxygen in the open pond. However, within the raceway cells, DO was maintained above 2.0 mg/L. This situation alarmed the farm manager and decisions were made to reduce the feed offering from 250 kg/ha/D to 175 kg/ha/D, thereby decreasing daily weight gain from 8.4 to 2.5 g/D.

- Under these circumstances, IPRS technology was able to produce only an average of 18,130 kg/ha at this trial harvest. This is very low for IPRS and is low compared to traditional ponds. Even with this low trial yield, IPRS technology does not require the emptying of ponds for harvest, and therefore a new batch of fingerlings can be stocked the same day after harvest. So, with all these errors, a crop cycle can be made inside 120 days, and it is therefore practical to expect three harvest per year with a total production minimum at 54,391 kg/ha/year
- Usually, tilapia in IPRS grow faster than traditional ponds; this trial yielded a ROI of 38.6% in IPRS compared to traditional ponds of 22.8%.

## Study Case 2: In-Pond Raceways System (IPRS) Experience with Tilapia in Chetumal, Q R, Mexico

### Introduction

In Mexico, like any other country, fish producers are always looking for ways to increase production and do it more efficiently. The progressive fish farmers try different technologies and some of them require more sophisticated knowledge, techniques and understanding of aquaculture principles to make them work predictably. In many countries, water availability is increasingly a significant challenge, especially for those fish producers that use water from rivers or streams. In many countries, not just Latin America, rivers are polluted, with coliform bacteria, chemicals and heavy metals. Water for aquaculture farms needs to be taken from boreholes or wells to supply fishponds. In many cases, the water table is declining,

making costs for pumping water into ponds increase. IPRS technology makes a serious contribution to water conservation and to the sustainability of pond aquaculture. Using IPRS, water is reused year after year and only seepage or evaporative loss is replaced.

### Trial Protocols

This trial's objectives are to be an introduction and standardization of IPRS protocols, to seek the opportunity to reduce time needed to complete culture cycles and allow three or more cycles per year instead of only two from traditionally managed ponds. The weight target for tilapia in this trial destined for the domestic market was 500 grams and up.

To achieve these objectives, two raceways were installed in a 0.9 ha pond, with a production zone (PZ) volume of 162.5 m<sup>3</sup> each, with a total of 325 m<sup>3</sup> of culture volume. This farm was the first IPRS in Latin America built using UV protected polyethylene pond liner material with wooden fence poles and lumber to provide a unique and inexpensive approach to construction. This construction material or approach was not recommended by USSEC. Water temperature, Total Ammonia Nitrogen (TAN), nitrite, pH and turbidity were monitored. Because of financial limitations and self-funding of the project, cash flow and market demand, the trial operator and fish producer elected to make multiple harvests during the production cycle.

**Figure 106.** Stocking

	Fecha	Wt/g	No.	Wt/kg	Mortalidad
<b>RW-1</b>	3/2/2019	85	25,770	2,202	96
<b>RW-2</b>	3/3/2019	82	26,409	2,168	177

Tilapia fingerlings were cultured in circular tanks up to 82 and 85 grams and were then stocked at 26,000 per raceway with very few mortalities at stocking. Tilapia were fed four times a day using a 35% protein diet. Fish growth was monitored every 14 days, by random sampling of the populations. Solid waste from fish was extracted by a trash pump, but unfortunately, no data was collected.

#### Trial Results

During this trial, dissolved oxygen occasionally dropped below 1.0 mg/L in the open pond but was maintained above 2.0 mg/L inside the raceway cells. Water temperatures ranged from a minimum mean of 27.5C in

the morning and a mean of 31.5C in the afternoon. Feed intake was reported at a maximum of 388 kg/ha/D. Total Ammonia Nitrogen (TAN) was measured as high as 0.25 mg/L, nitrite also as high as 0.01 mg/L, Nitrate as 10 mg/L, pH stable at 7.5 and turbidity at 30 cm. After feeding was initiated and TAN began to increase, fish waste extraction was performed manually several times a day. This, at least in part, brought about a decrease in the TAN reading of 0.00 mg/L. It is noteworthy that in this single cycle trial, the stocking weights of fingerlings were 82 and 85 grams and considering the combination of healthy levels for DO, low TAN,

nitrite and partial harvest, resulted in production of 11,765 kg/ha/RW-1 and 15,578 kg/ha/RW-2 in 68 days and 98 days, respectively. Therefore, an estimated total of 132,676 kg/ha/year can be expected using IPRS. Considering all costs and sales revenue, the ROI was not of 65%. This was the highest reported ROI on all trials performed thus far due to stocking larger fish and using less expensive IPRS construction.

Water flow at this farm varies from 9.8 cm/s using one blower, to 16 cm/s with two blowers running.

**Figure 107.** Production of RWs 1 and 2

VARIABLE	Total RW-1	Total RW-2
Production days	68	98
Fish stocked	25,770	26,409
Fish harvested	23,190	25,357
Survival %	89.99	96.02
Harvest wt/kg	11,765	15,578
Average g/day	5.66	5.43
Harvest kg/m <sup>3</sup>	72.40	95.86
Production kg/Ha/rw/year	69,152	63,524
FCR	1.2	1.3
<b>Production kg/Ha/año</b>	<b>132,676</b>	

**Figure 108.** Financial performance for tilapia production using two RWs of 162.5 m<sup>3</sup> each in a 0.9 ha pond.

VARIABLE	Costco USC	%
Fingerlings	9,472	23
Feed	25,770	53
Labor	3,843	9
Electric power	1,829	4
Treatments/others	500	1
Operation costs	37,786	90
Fix costs		
RW, blowers, etc.	4,000	10
Total costs	41,786	100
Sales	68,932	
Profits	27,146	
<b>ROI%</b>	<b>65</b>	

**For more information  
about IPRS, contact  
IPRS@ussec.org.**

### Summary and Conclusion

IPRS constructed using wooden fence poles and pond liners are functional, productive and inexpensive. Life of this unit is unknown.

- Stocking tilapia fingerlings at 82 grams and larger per fish significantly reduced growing days and based on this trial 3.5 harvest a year can be easily achieved.
- Partial harvest in this trial increased production by reducing biomass in raceway cells as fish grow, resulting in 15.5 metric tons of production per raceway, per harvest. USSEC does not recommend partial harvest, especially when fish are "selected" by size. It is excessively stressful on most species. In this trial partial harvest was done with care, no stress was observed or detected on the fish.
- In these commercial raceways of 162.5 m<sup>3</sup>, biomass at harvest of 72.4 and 95.8 kg/m<sup>3</sup> was obtained. Feed utilization resulted in an FCR of 1.2 and 1.3 which is compatible with other trials.
- When IPRS was constructed using less expensive materials as seen in this trial:
  1. Stocking tilapia fingerlings at 82 grams per fish or larger.
  2. Extracting fish solid waste from the pond; sustainability and profitability was obtained with an ROI of 65%.

## Study Case 3: Intensive Tilapia Nilotica Culture in In-Pond Raceway Systems (IPRS), Veracruz, Mexico

### Introduction

In Mexico, tilapia production has reached 56.5% of the total freshwater aquaculture production, and fish producers are always looking for ways to improve production and minimize loss to disease and parasites, as well as from bird predation, while earning an attractive ROI. One of the principal strong points of the IPRS technology is that solid fish waste is collected and removed from the IPRS pond and thereby, helps to maintain good water quality throughout the culture cycle. In this case, data illustrates the significance of the fish waste removal principle and its interaction with the pond and local weather on the nitrogen cycle, resulting in a significant improvement in fish production.

### Trial Protocols

The objective of this trial, as others have been, is to introduce and validate IPRS principles on the culture of Nile Tilapia (*Oreochromis niloticus*) to market target size of 500 grams. Tilapia were fed using U.S. soybean meal inclusion in the diet.

Ten commercial fish raceways were installed in a 3.39 ha pond containing a total water volume of 108,265 m<sup>3</sup>. Each raceway cell held 275 m<sup>3</sup>, for a total of 2750 m<sup>3</sup> of culture volume. Of the total 10 raceways, four were used for this trial. Five more also were stocked with fish (tilapia) but not part of the trial and one was not stocked. Raceways were stocked with 38,000 fish (138 m<sup>3</sup>), with an average weight of 45.25 grams. Dissolved oxygen (DO) and temperature were monitored and recorded morning and afternoon. Total Ammonia Nitrogen (TAN), nitrites and pH were recorded weekly, while alkalinity and hardness were recorded monthly. In addition, a determination and presence of un-ionized ammonia was calculated. Fish were sampled every 14 days by weighing and measuring a random group of 125 fish. The sampled fish were weighed to determine average sample for individual weight in grams, further, 30 fish in the sample were measured and weighed individually for analysis using the Fulton Condition Factor tool.

Fish were fed the first month with 35/7% (protein/lipid), and over the following months with 32/6% (protein/lipid). The inclusion rate of U.S. soybean meal in the diets were 43.4% and 33.4%, respectively. A total harvest kg/ha/harvest and kg/ha/year was estimated.

### Trial Results

During the first month after stocking, water temperatures were recorded within the optimal range for tilapia, but over the last two months, pond temperature in the morning were measured as low as 20C on some days, but in general, water temperature was below optimal at 23C. Total Alkalinity was measured at 170 mg/L, total hardness was determined at 219 mg/L and pH was steady at 7.5. After feeding was initiated, nitrite = <0.026 mg/L, nitrates = 0.675 mg/L, but Total Ammonia Nitrogen was reported as high as 6.1 mg/L. Feed offered and intake was correlated to TAN and reached as high as 800 kg/ha/day. Farm managers reduced feed offered/intake in a response to reduce TAN reading.



Analysis of un-ionized ammonia calculated its proportions based on pH, temperature and TAN, resulted in a 0.14 mg/L (un-ionized ammonia), when TAN was 6.1 mg/L. Un-ionized ammonia did not reach toxic levels in this trial. Average weight gain was measured as high as 12 g/D, but when feed offerings were reduced, responding elevated TAN was reading 6.1 and cooler temperature, weight gain per day was dramatically reduced, to an overall cycle average of 3.8 g/D.

This is lower than weight gain per day recorded on other trials with Nile tilapia. The Fulton Condition Factor similarly showed a lowered reading than expected. An average of 2.31 was observed, (range 2.28 to 2.35) and survival overall on this trial was 82%. Total number of days documented for this trial was 127 and achieved an average yield output of 60.15 kg/m<sup>3</sup> within the raceway cells. Average yield across four tilapia raceways was 16,542 kg/RW.

By calculation, if all 10 raceway cells are used in production, then it should follow that an annual yield of 165,420 kg could be harvested from a 3.39 ha pond holding 108,265 cubic meters of volume compared to traditional production of 48,780 kg/ha/year. If 127 days is used for each culture cycle to reach harvest target weight (500 g), 2.87 cycles per year can be routinely achieved. Unfortunately, no financial data was collected. Potential of 140,000 kg/ha/year was demonstrated within 108265 cubic meters of pond volume.

**Figure 109.**

	RW-1	RW-2	RW-3	RW-4	Average/ RW	Totals
Initial # of fish	38,000	38,000	38,000	38,000		
Initial Wt/g	45	48	47	41	45.25	
Initial Wt/kg	1,699	1,817	1,801	1,547	1,716	
Days	127	127	127	127	127	
Survival %	86	90	74	79	82	
Final average Wt/g	475	533	588	527	531	
Final Wt/Rw/kg	15,541	18,239	16,469	15,920	16,542	<b>66,169</b>
Gain Wt/kg	13,842	16,422	14,668	14,373	14,826	<b>59,305</b>
FCR	1.31	1.15	1.39	1.28	1.28	
Weight kg/m <sup>3</sup>	57	66	60	58	60.15	
Daily weight gain Wt/g	3.6	3.9	4	3.7	3.8	
Fulton Condition Factor	2.28	2.33	2.28	2.35	2.31	
<b>Production kg/Ha/year</b>						<b>140,048</b>

## Summary and Conclusion

- This commercial and industrial scale tilapia production trial using IPRS was a very beginning exploration for the farm using IPRS. Even though it was early on the learning curve, it is still considered one of the most illustrative and productive of all trials in Latin America to date. Further, it was conducted during the coolest months of the year, and the performance of the IPRS approach was very attractive to the producer and those observing it.
- Four raceways were used for the trial, yielding a total of 66,169 kg with the average raceway production recorded at 16,542 kg per cell. If we expand this yield to the full 10 raceways, then 165,422 kg/harvest/cycle is estimated. Therefore, 3.39 ha holding 108,265 m<sup>3</sup> of volume within the pond, then in this case, a 48,780 kg/ha/harvest cycle estimate can

be made. Across 2.5 cycles per year, an estimated conservative annual yield of 121,950 kg/ha can be projected using IPRS.

- Feed intake reached up to 800 kg/ha/D, the phytoplankton and particularly the nitrifying bacteria and other biota were not active enough during the trial in converting TAN into nitrite and then nitrate. When an accumulation of TAN was measured, facility managers were concerned by an increase in TAN and decided to reduce feed offering per day. Thus, this reduced feed intake. Consequently, the Fulton Condition Factor index readings declined as did feed efficiency (FCR) and daily weight gain. At the new feed offering level, the fish were not fed enough for them to grow efficiently, rather, this level was barely above maintenance.

But given the ammonia (and un-ionized ammonia) levels and possible nitrite levels to follow combined with the experience with IPRS, reducing feed volume offered was a sound decision.

- With a robust and mixed phytoplankton bloom as well as a healthy nitrifying bacteria community, a feed intake of 800 kg/ha/D using IPRS can be routine. IPRS technology allows routine ability to collect and extract fish waste solids from the IPRS pond and can play a strong role in further improving the high production yield demonstrated in this trial. Unfortunately, data collection regarding waste solids collection and removal was not possible during this trial.

## Study Case 4: Culture of Red Tilapia In IPRS Raceways and Comparing Two Commercial Diets

### Introduction

IPRS technology has been criticized by some in the scientific community, because, according to them, only on a few occasions were scientific evaluations used in the evaluation and validation of the technology. This trial featured culture red tilapia in Honduras and was able to provide data to respond to some of these questions. This trial continues to add evaluation and validation of IPRS principles in terms of production, days required for culture, water conservation and reduced or zero discharge of nutrient rich water into natural rivers, lakes or lagoons.

### Trial Protocols

This trial objective was to conduct an experiment using scientific protocols with red tilapia destined for a domestic Honduras market (size of 0.270 to 0.340 kg fish). Two commercial diets were evaluated, named "Diet A" and "Diet B", with the hypothesis that Diet B was better than Diet A for weight gain, feed efficiency and survivorship. The experiment was set up in a pond 0.4225 ha containing 15,632 m<sup>3</sup> total pond volume. Production units were 20 small floating raceways each containing 14.5 m<sup>3</sup> and a total of 290 m<sup>3</sup> of culture volume.

From the total number of raceways, 12 were randomly selected to use in this trial, six replicates for Diet A and six replicates for Diet B. Each raceway replicate was stocked with 4200 fish, equivalent to 289.6 fish/m<sup>3</sup>. Mean initial weight for Diet A=37.29 g and for Diet B= 39.4 g. After stocking, fish were sampled every 14 days, wherein 100 fish per raceway were sampled to determine average individual weight, and 25 fish measured for total length to the nearest centimeter and total weight in grams for Fulton Condition Factor analysis. Water temperature and dissolved oxygen were determined and recorded both morning and afternoon.

Total Ammonia Nitrogen (TAN), nitrite and pH were measured and recorded weekly; alkalinity and hardness readings were determined and recorded monthly. Fish were fed 38% protein during the first month and 32% protein thereafter. Daily ration was divided for feeding six times each day. At the conclusion of the trial (fish reached target weight 270-340 g), both treatments and all replicates were harvested within two days. Analysis of trial data regarding production yield per the Diets A and B were determined for each diet (yield kg/m<sup>3</sup>, yield kg/ha/year in 15632 cubic meters pond volume, Fulton Condition Factor Analysis and FCR).

### Trial Results

Fish were harvested after 117 days with mean weight per fish from treatment A= 331.7 grams, and treatment B=358.4 grams. The hypothesis for Diet B to perform better than Diet A was tested with Student's T-test statistical analysis. Average weight from treatment Diet B did not show statistically significant differences from Diet A (t stat (df=10) = 1.14, P = 0.09 (1 tail). Even though the Diet B average final weight was higher than Diet A, the difference was not significant. Mean weight gained per day in Diet B=2.72 g/D compared to Diet A=2.51 g/D. Feed Conversion efficiency (FCR) averaged for Diet B=1.46 and Diet A=1.36. Fulton Condition Factor analysis averages for Diet B=2.2 and Diet A=2.21 indicated that, for both diets, fish were fed consistently and grew well, and were in healthy condition (t stat (df =398) = 0.27, P = 0.39 (1 tail)) at the conclusion of the trial. Diet B yielded an average of 1273 kg per raceway compared to Diet A of 1245 kg per raceway. Similar yields were recorded per unit volume (kg/m<sup>3</sup>),

Diet B=87.84 and Diet A=85.88. However, Diet A demonstrated an FCR of 1.36, somewhat lower than Diet B=1.46. As a result, an economic analysis for Return on Investment showed somewhat better ROI when Diet A=46.97 was compared to Diet B=42.8). During the last month of the trial, dissolved oxygen from morning readings dropped below 2.0 mg/L occasionally in the open pond, but it was maintained at 2.0 mg/L or greater within the inside raceway cells. An increase in nitrite reading also was observed during this period along with a decrease in fish appetite. Managers responded by increasing the frequency of fish solid waste extraction.

Alkalinity and hardness were measured and recorded at 12 mg/L but amended by adding pulverized Dolomitic limestone to the pond. Subsequently, measures for these important parameters improved to 188 mg/L alkalinity and 78 mg/L hardness.

**Figure 110.** Results of production

	A	B	Average
No. days	117	117	117
Initial ave. Wt/g	37.29	39.4	38.35
Final ave. Wt/g	331.73	358.44	345.08
Initial wt/kg	157	166	161.50
Final ave. Wt/kg	1245.86	1273.67	1259.76
Initial kg/m <sup>3</sup>	10	11	10.50
Final kg/m <sup>3</sup>	85.88	87.84	86.86
g/day	2.51	2.72	2.62
FCR	1.36	1.46	1.41
SGR%	2.17	2.15	2.16
Fulton's condition factor	2.21	2.2	2.21
Survival %	88.97	85.24	87.11
Prod. kg/Ha/cosecha			59,633.77
<b>Prod. kg/Ha/year</b>			<b>119,267.53</b>



**Figure 111.** Comparative budgets for red tilapia with two commercial diets

	Diet A	%	Diet B	%
Labor	3,145.6	16.93	3,145.6	16.93
Electric power	1,907.9	10.27	1,907.9	10.27
Treatments	5.2	0.03	5.2	0.03
Maintenance	53.9	0.29	53.9	0.29
Fingerlings	2,405	12.94	2,405	12.94
Feed	6,531.8	35.15	7,464.5	40.17
Total operation cost	14,049.4	75.61	14,982.2	80.63
Fix cost (RWs)	3,600	19.37	3,600	19.37
<b>Total cost</b>	<b>17649.40</b>	<b>100</b>	<b>18,582.2</b>	<b>100</b>
Sales 3.47/kg	25,939		26,535	
Profits	8,289.6		7,952.8	
<b>ROI %</b>	<b>47.0</b>		<b>42.8</b>	

### Summary and Conclusion

- Growth and weight gain performance for commercial Diet B was not significantly different from Diet A (P=0.09%), even though Diet B grew fish slightly faster (358.4 g v 331.7g) and yielded more (1273 v 1245 kg/ raceway).
- This fish farm is located at 1,200 meters above sea level. If approximately 117 days are assumed for a culture cycle,

only two harvests can be realized given the same stocking weight for fingerlings. So, if we use the yield figures demonstrated in this trial as standard per hectare per cycle, (59,633 kg/ha/ harvest cycle) and two harvest cycles per year are planned, it is reasonable to expect approximately 119,267 kg/ha/year.

- This experiment proved that the unit that yielded the most weight is not necessarily the

most economical or profitable. Diet A demonstrated an ROI=47.0 while was Diet B=42.8. For ROI, the most important difference of the economic factors, driving the ROI, Feed Conversion Ratio (FCR), A= 1.36 v B=1.46 was the most important factor.

- See Appendix F. for References and Literature Citations

## SECTION 8.2: Case Study: Tilapia (Egypt)

# Report on Adoption of IPRS Technology in Egypt

**Report Preparation Date:** 2020

**Author:** Dr. Gamal El Naggar, USSEC  
Aquaculture Consultant and Country  
Representative for Egypt

**Location:** Egypt

### Introduction

This report represents a detailed description of design, construction and operational activities for one of the most successful IPRS units in Egypt. This is a three-cell unit for tilapia production on one of the private fish farms located south of Lake Edku in Behera that represents one of the major fish farming areas in the country. Results of demonstration trials over three production seasons (2019-2021) of this IPRS technology in Egypt showed the potential for increasing fish production with no water exchange, the opportunity for optimizing feed volume applications, simplified and lower cost for fish harvesting procedures and labor of this environmentally sustainable culture system.

Fish production level reached 9.15 tons per feddan in 2019 (two-fold of the average production levels), jumping to 14 tons per feddan in 2020 (three and half times of the average production level of 4 tons). Preliminary results from the first crop harvest for the 2021 growing season are encouraging, and we still have to wait for final total harvest records to show solid data on this year's production.

One important outcome of these trials is the economic performance, the farm owner says that despite the difficult economic conditions for almost all fish farmers in Egypt for the last two years, his pond with the IPRS unit was making good profit overall, which is very encouraging sign of the system's potential for making the fish farming sector profitable and more sustainable.

### Rationale and Introduction

Egyptian aquaculture has expanded rapidly, developing into a strategically important food source for the country and a significant sector for its economy. In 2019, aquaculture production reached over 1.64 million metric tons, accounting for more than 80% of the country's total fish production. In the same year, fisheries production was 397,000 mt (see table below). The sector provides employment for almost 1 million people (200,000 in the aquaculture value chain and 700,000 in fisheries). The impact of this substantial growth resulted in an increase of the per capita fish availability from around 15 kg per year to over 21 kg per year over the last decade despite the continued population increase.

**Figure 112.** Fish production in Egypt and contribution of its different subsectors (aquaculture and captured fisheries) in the last decade from 2010 to 2019

	2010	2011	2012	2013	2014	2015	2016	2017	2018	2019
Captured fisheries (tons)	385,209	375,354	354,237	356,857	344,791	344,112	335,613	368,316	373,285	397,000
Aquaculture production (tons)	921,585	986,820	1,017,738	1,097,544	1,137,091	1,174,831	1,370,660	1,451,610	1,561,457	1,640,000
Total fish production	1,304,794	1,362,174	1,371,975	1,454,401	1,481,882	1,518,943	1,706,237	1,810,389	1,934,742	2,037,000
(of which fish farming % is)	70.4%	72.4%	74.0%	75.3%	76.6%	77.2%	80.3%	80.2%	80.7%	80.5%

There are still major challenges facing the aquaculture industry in Egypt despite significant development and rapid expansion in the application of new technologies, such as the use of extruded feed, water circulations systems and improved farm management practices. These challenges include rising land value and increasing pond rental costs that require greater economic return from fish farms, limited and declining water availability and quality issues, in addition to increasing food safety concerns. Egypt is importing more than 300,000 tons of fish annually to meet consumer demand (GAFRD). The high demand for fish and other limitations the sector faces on water and land creates urgent need to intensify production in existing production areas which is currently estimated to be about 115,000 hectares of aquaculture farm ponds. With limited land availability for horizontal expansion of aquaculture production in Egypt, intensification of production in existing fish farming zones is needed to address these constraints and ensure the economic sustainability of the industry.

The IPRS technology addresses sector constraints by allowing greater management control that yields higher fish production at lower per-unit cost through improved fish survival and feed conversion. The zero-water exchange captures nutrients for use as a crop fertilizer and requires minimal use of antibiotics and chemicals to ensure food safety. Other advantages of the system are their ease to sample, grade and harvest fish and the ability to enable biosecurity to minimize the opportunity of disease outbreaks.

For these reasons, the IPRS was selected for testing in Egypt as a means to address the increasing demand for aquaculture products in the face of mounting economic and environmental constraints to the growth of Egyptian aquaculture production.

In 2017, USSEC partnered in Egypt's first IPRS for tilapia production. Final harvest results from the first trial of the IPRS unit showed productivity levels of 60 kg per cubic meters, leading to doubling the overall productivity of the pond.

In 2018, building on the findings of the 2017 trials of IPRS, USSEC began working with local partners on developing an IPRS that was most compatible with local economic conditions and could have high potential for adoption by farmers across the country.

In 2019, USSEC supported private commercial fish farms to build conventional IPRS units in Beheira and worked on developing a IPRS at a commercial farm in Kafr El Shaikh. In 2020, USSEC supported the General Authority for Fish Resources Development (GAFRD) in construction and operation of six IPRS units in two of the governmental farms and three at a fish farm in Dakahlia for African catfish production. The other three units were built at a fish farm in Kafr El Shaikh and used for tilapia production.

The geographic expansion of the IPRS units covers most of the important fish farming areas in the country (Kafr El Shaikh, Beheira, Sharkia, Dakahlia, Giza and Fayoum). Now the total number of IPRS in Egypt is 33 units on private and governmental farms.

Looking into the farming systems in Egypt, we can see that the pond system represents more than 90% of the total aquaculture production and more than 1.5 million tons of fish, of which 1.1 million tons are tilapia. If we assume that 20% of the tilapia pond farming system in Egypt adopt the IPRS technology over the next five years, consequently, they will triple their annual production. This will lead to over 600,000 tons of additional tilapia coming from the IPRS over current production. This additional production will need about 820,000 tons of feed (with 1.3 FCR) and additional demand of 290,000 tons of soybean meal (with 35% soy inclusion rates) of which no less than 200,000 tons from U.S. Soy.

### Materials and Methods

- **System Design and Description:**

This report will describe one of the most successful IPRS units in Egypt. This tilapia producer and hatchery is located in one of the largest fish farming regions in Egypt and is on the edge of Lake Idku. It is a very large fish farm by Egyptian standards and comprises 280 total land acres and 230 acres of water area. The farm employs 52 workers, including security.



Ponds average 1 to 1.5 ha in size and 1.5 meters deep, which makes this farm an ideal partner for adopting the IPRS technology. The pond used for the first IPRS is 0.675 ha (1.6 feddans) and 1.6 meters deep with a total water volume of 11,200 cubic meters.

Three Identical raceways or fish production cells were constructed on the eastern side of the renovated pond with 12-meters long, 3-meters wide and 1.6-meters deep (12m x 3m x 1.6m) with a 4-meter Quiescent Zone (QZ).

**Figure 113A.** Three Identical raceways (12m x 3m x 1.6m)



**Figure 113B.** Four-meter QZ  
All the in-pond raceways/cells were equipped with the WWUs



Five air lift units (WhiteWater unit) 3 m long, 1.2 m wide and 1.1 m depth fabricated for use in the three cells and the open pond (Figure 3). The unit floating in the lower end of the pond was supplied with a separate air blower while the second one in the open pond along with the three WWUs on the cells were connected to side air blower of 5 hp capacity to produce enough air for making sufficient current to remove the solid waste and supply oxygen to fish.

**Figure 114A & B.** WhiteWater Units connected to the IPRS cells and in the open pond. Solid wastes were collected two or three times daily by manually vacuuming from the QZ. Waste was pumped to waste settling tank at pond bank.



- **Operating the System:**

First year production trial was in 2019. The first operational season was during the period from 27 August to 17 December 2019.

*Starting date: 27 August 2019*

*Harvest date: 17 December 2019*

*Growing period: 112 days*

**Water:** The pond was filled with clean freshwater from the adjacent canal at the start of the growing period. The cells/pond were operated for the duration of the demonstration without any water discharge, other than to periodically replace water seepage and evaporation losses. No flushing or other exchange of pond water was permitted.

**Fish:** The in-pond raceway cells were stocked with Nile tilapia fingerlings averaging 32 grams and received from the hatchery located on the farm itself. Before stocking, the fish were immersed in potassium permanganate solution 20 mg/l for 30 minutes as prophylactic treatment for control of skin and gill parasites and external bacteria. At intervals after stocking, therapeutants were used in managing fish health was formalin, (37%) at 250 mg/l for 30 minutes.

**Feed:** All tilapia were fed the USSEC approved 35/6%, 32/6% and 30/6% extruded soy-based feed. For the different size fish according to the following:

*35/6%- fish size 30gr to 100gr*

*32/6%- fish size 100gr to 250gr*

*30/6%-fish size 250gr to 500gr*

Fish were fed multiple times daily using the USSEC feed by the 90% average satiation feeding technique. Interim FCR data for each sampling period will be valuable in identifying changes in feed efficiency over time.

### Results and Discussion

This trial continued for 110 days from stocking to harvest. The tables below show details of stocking data for the three cells and performance of the fish in each cell from stocking to harvest. Complete harvest of trial cells carried out in mid-

December 2019 and for the open pond area April 2020 with a total fish production of 14.65 tons of fish (8.37 tons from the three IPRS cells plus 6.28 tons from the pond).

This total production from the 1.6 feddan pond means a production rate of **9.15 tons per feddan** which is more than double the current average common production rate of the earthen ponds system in Egypt.

**Figure 115.** 2019 data of tilapia production from first growing cycle

Parameter	Cell 1	Cell 2	Cell 3	Totals
Water volume	54 m <sup>3</sup>	54 m <sup>3</sup>	54 m <sup>3</sup>	162 m <sup>3</sup>
Number of fish stocked cell	10,000	12,550	15,000	37,550
Stocking density/m <sup>3</sup>	185	232	277	
Initial stocking weight (g)	32	32	32	
<b>Total recorded mortality</b>	<b>1,922</b>	<b>2,087</b>	<b>2,766</b>	<b>6,775</b>
Estimated number of surviving fish	8,078	10,463	12,234	30,775
Fish survival (%)	80	83	82	

Parameter	Cell 1	Cell 2	Cell 3	Totals
Number of fish stocked cell	10,000	12,550	15,000	37,550
Initial stocking density/m <sup>3</sup>	185	232	277	
Corrected stocking density after counting mortalities	150	194	227	
Initial stocking weight (g)	32	32	32	
<b>Total fish harvest (kg/cell)</b>	<b>1,780</b>	<b>2,817</b>	<b>3,706</b>	<b>8,374</b>
<b>Average final weight (g)</b>	<b>220</b>	<b>255</b>	<b>302</b>	
Net weight gain (kg/cell)	1,521	2,482	3,315	7,318
Growing period (days)	110	110	110	
Daily weight gain (g/fish/day)	2.02	2.55	2.98	
Feed consumed (kg/cell)	1,764	3,272	4,611	9,647
FCR	1.16	1.32	1.39	

### Second year production trials in 2020

This year plans were determined earlier to start as early as possible in order to be able to produce two crops per year from the IPRS unit.

- **First production cycle:**

*Starting date: 28 April 2020*

*Harvest date: 28 August 2020*

*Growing period: 100 –120 days*

The two tables to the right illustrate all recorded details of the first production cycle.

- **Second production cycle:**

*Starting date: 29 August 2020*

*Harvest date: 19 December 2020*

*Growing period: 112 days*

The two tables below illustrate all recorded details of the second production cycle.

**Figure 116.** 2020 Data of Tilapia Production from Year 2, First Growing Cycle

Parameter	Cell 1	Cell 2	Cell 3	Totals
Number of fish stocked cell	12,045	12,550	16,385	43,020
Stocking density/m <sup>3</sup>	223	270	303	
Initial stocking weight (g)	38.4	15.29	14.7	
<b>Total recorded mortality</b>	<b>90</b>	<b>95</b>	<b>138</b>	<b>323</b>
Estimated number of surviving fish	11,955	14,495	16,247	42,697
Fish survival (%)	99.7	99.3	99.1	

Parameter	Cell 1	Cell 2	Cell 3	Totals
Number of fish stocked cell	12,045	14,590	16,385	43,020
Stocking Density/m <sup>3</sup>	223	270	303	
Initial stocking weight (g)	38.4	15.29	14.7	
<b>Total fish harvest (kg/cell)</b>	<b>3,625</b>	<b>3,445</b>	<b>3,425</b>	<b>10,495</b>
Average final weight (g)	303	238	211	
Net weight gain (kg/cell)	3,162	3,222	3,184	9,568
Growing period (days)	100	120	120	
Daily weight gain (g/day/fish)	2.19	1.84	1.62	
Feed consumed (kg/cell)	4,854	4,945	4,887	14,686
FCR	1.34	1.44	1.43	

**Figure 117.** 2020 data of tilapia production from year 2, second growing cycle

Parameter	Cell 1	Cell 2	Cell 3	Totals
Initial number of fish stocked/cell	12,042	12,449	12,079	36,370
Stocking density/m <sup>3</sup>	223	226	223	
Initial stocking weight (g)	37.5	43.12	42	
<b>Total recorded mortality</b>	<b>2,529</b>	<b>2,572</b>	<b>3,141</b>	<b>8,242</b>
Estimated number of surviving fish	9,513	9,677	8,938	28,128
Fish survival (%)	79	82	74	
Corrected stocking density after counting mortalities	176	179	166	

Parameter	Cell 1	Cell 2	Cell 3	Totals
Initial stocking weight (g)	37.5	43.12	42	
Initial stocking density/m <sup>3</sup>	223	226	223	
Fish survival (%) after stocking mortalities	79	82	74	
Corrected stocking density after counting mortalities	150	194	227	
Growing period (days)	110	110	110	
<b>Total fish harvest kg/cell</b>	<b>1,608</b>	<b>1,839</b>	<b>1,720</b>	<b>5,166</b>
<b>Average final weight (g)</b>	<b>168</b>	<b>182</b>	<b>193</b>	
Net weight gain (kg/cell)	1,251	1,421	1,345	4,017
Daily weight gain (g/fish/day)	1.20	1.34	1.37	
Feed consumed kg/cell	2,572	2,758	2,924	8,255
FCR	2.06	1.94	2.17	



### Total production for year 2020 including IPRS plus service species:

**Figure 118.** The following tables sums up total fish production of the two crops from IPRS unit plus the open pond harvest of the service species (non-fed species).

Production source	Total Production (kg)	Start Date	Harvest Date
IPRS unit first crop	10,495	28-Apr-20	28-Aug-20
IPRS unit second crop	5,400	29-Aug-20	19-Dec-20
Service species pond	6,400	15-Apr-20	19-Feb-21
<b>Total production from the whole system</b>	<b>22,295</b>		

Complete harvest of trial cells carried out in mid-December 2020 and for the open pond area February 2021. These production levels indicated that total fish harvest from the trial was **22.3 tons** (15.9 tons from the three IPRS cells plus 6.4 tons from the pond). This total production from 1.6 feddan pond translates to a productivity rate of **13,934 (kg/feddan)** which is more than triple the common production levels in Egyptian aquaculture standards (4 tons / feddan).

### Third year production trials in 2021

- **First production cycle:**  
*Starting date: 12 April 2021*  
*Harvest date: 7 August 2021*  
*Growing period: 117 days*

**Figure 119.** 2020 data of tilapia production from year 2, third growing cycle

Parameter	Cell 1	Cell 2	Cell 3	Totals
Initial number of fish stocked/cell	12,000	15,000	15,400	42,400
Stocking density/m <sup>3</sup>	222	278	285	
Initial stocking weight (g)	34.88	29.52	37.52	
<b>Total recorded mortality</b>	<b>1,820</b>	<b>4,310</b>	<b>1,970</b>	<b>8,100</b>
Estimated number of surviving fish	10,180	10,690	13,430	34,300
Fish survival (%)	84.83	71.27	87.21	
Corrected stocking density after counting mortalities	189	198	249	

Parameter	Cell 1	Cell 2	Cell 3	Totals
Initial stocking weight (g)	34.88	29.52	37.52	
Initial stocking density/m <sup>3</sup>	222	278	285	
Fish survival (%) after stocking mortalities	84.83	71.27	87.21	
Corrected stocking density after counting mortalities	189	198	249	
Growing period (days)	116	116	116	
<b>Total fish harvest kg/cell</b>	<b>2,354</b>	<b>2,420</b>	<b>3,001</b>	<b>7,775</b>
<b>Average final weight (g)</b>	<b>231</b>	<b>226.4</b>	<b>223.5</b>	
Net weight gain (kg/cell)	1,999	2,420	3,001	6,601
Daily weight gain (g/fish/day)	1.69	1.70	1.60	
Feed consumed kg/cell	3,103	3,213	4,009	10,325
FCR	1.55	1.53	1.61	

## Observations and Remarks

**Figure 120.** The two tables below are collective data figures with all production details for the production cycles

Production year	2019 (27-Aug to 17-Dec)			2020 First Crop (28-Apr to 18-Aug)			2020 Second Crop (29-Aug to 18-Dec)			2021 First Crop (21-Apr to 7-Aug)		
	Cell 1	Cell 2	Cell 3	Cell 1	Cell 2	Cell 3	Cell 1	Cell 2	Cell 3	Cell 1	Cell 2	Cell 3
Number of fish stocked/cell	10,000	12,550	15,000	12,045	14,590	16,385	12,042	12,249	12,079	12,000	15,000	15,400
Stocking density/m <sup>3</sup>	185	232	277	223	270	303	223	226	223	222	278	285
Initial stocking weight (g)	32	32	32	38	15	15	38	43	42	35	30	38
Total recorded mortality	1,922	2,087	2,766	90	95	138	2,529	2,572	3,141	1,820	4,310	1,970
Number of surviving fish	8,0878	10,463	12,234	11,955	14,495	16,247	9,513	9,677	8,938	10,180	10,690	13,430
<b>Fish survival (%)</b>	<b>80</b>	<b>83</b>	<b>82</b>	<b>100</b>	<b>99</b>	<b>99</b>	<b>79</b>	<b>82</b>	<b>74</b>	<b>85</b>	<b>71</b>	<b>87</b>

Production year	2019 (27-Aug to 17-Dec)			2020 First Crop (28-Apr to 18-Aug)			2020 Second Crop (29-Aug to 18-Dec)			2021 First Crop (21-Apr to 7-Aug)		
	Cell 1	Cell 2	Cell 3	Cell 1	Cell 2	Cell 3	Cell 1	Cell 2	Cell 3	Cell 1	Cell 2	Cell 3
Initial stocking weight (g/fish)	32	32	32	38	15	15	38	43	42	35	30	38
Initial stocking density/m <sup>3</sup>	185	232	277	223	270	303	223	226	223	222	278	38
Stocking density of surviving fish/m <sup>3</sup>	150	194	227	221	268	301	176	179	166	189	198	249
Growing period (days)	110	110	110	100	120	120	110	110	110	116	116	116
<b>Total fish harvest (kg/cell)</b>	<b>1,780</b>	<b>2,817</b>	<b>3,706</b>	<b>3,625</b>	<b>3,445</b>	<b>3,425</b>	<b>1,608</b>	<b>1,839</b>	<b>1,720</b>	<b>2,354</b>	<b>2,420</b>	<b>3,001</b>
<b>Fish production (kg/m<sup>3</sup>)</b>	<b>33</b>	<b>52</b>	<b>69</b>	<b>67</b>	<b>64</b>	<b>63</b>	<b>30</b>	<b>34</b>	<b>32</b>	<b>44</b>	<b>45</b>	<b>56</b>
<b>Average final weight (g)</b>	<b>220</b>	<b>255</b>	<b>302</b>	<b>303</b>	<b>238</b>	<b>211</b>	<b>169</b>	<b>182</b>	<b>193</b>	<b>231</b>	<b>226</b>	<b>224</b>
Net weight gain (kg/cell)	1,521	2,482	3,315	3,162	3,222	3,184	1,251	1,421	1,345	1,999	2,104	2,497
Daily weight gain (g/fish/day)	1.71	2.16	2.46	2.64	1.85	1.63	1.20	1.33	1.37	1.69	1.70	1.60
Feed consumed (kg/cell)	1,764	3,272	4,611	4,854	4,945	4,887	2,572	2,758	2,924	3,103	3,213	4,009
FCR	1.16	1.32	1.39	1.34	1.44	1.43	2.06	1.94	2.17	1.55	1.53	1.61

The data illustrates the progress made from year one operation until 2020, the many lessons that could be learned from these trials, means to progressively enhance and improve management skills based on analyzing the data carefully and critically.

Based on the results obtained from this IPRS unit, we can see that the farmer had successfully applied and strictly followed the general principles and regulations for IPRS management and operation. He managed to double his pond productivity in the first operational year, and in 2020, he adopted a double cropping system and was able to even reach high productivity from the pond equaling three folds of average pond production rates.

The farmer reported that this particular pond generated good profits despite the fact that almost all farmers are not making any profits due to current low sale prices for produced fish and rising production costs.

This farmer is planning to expand in constructing more IPRS units both on the same farm in Behera and his other farm in El Menya in upper Egypt. In closing, the farmer is a very successful and innovative fish farmer, and many in Egypt should follow his steps in their search for sustainability and look to his example in overcoming the serious challenges facing them.

**"Initiation of such experiments with modern systems and their future development. After studying operating errors must affect the development of the fish sector in Egypt, along with its positive impact in terms of yield and profitability under conditions of limited water and poor quality. We recommend the need to raise the level of density of the living mass in cubic meters so that it is not less than 40 Kg, and this is what we look forward to practically applying in the 2020 season after studying all the wrong practices in the 2019 trial."**

**-Egyptian aquaculture producer utilizing IPRS technology**

**Figure 121A & B.** Farmers showing off their products





## SECTION 8.3: Case Study: Grass Carp (Vietnam)

# Commercial Grass Carp Production by In-Pond Raceway System in Red River Delta Region

**Report Preparation Date:** 2021,  
Trial date: 2019-2020  
**Author:** Dr. Thanh, Bui Ngoc  
**Location:** Northern Vietnam

### Introduction

The study was conducted at a 2-raceway IPRS farm in Hà Nam District, Vietnam, aiming to evaluate whether IPRS technology is profitable. Grass carp were selected to stock in 2 raceways and fed with commercial feed. Fish grew up from 1,150 g to 3,150 g with total biomass of 14.467 mt in Cell A after 150 days post-stocking, while they grew from 750 g to 2,750 g with total biomass of 12.342 mt in Cell B after 189 days post stocking. Net revenue was 134,549,285.33 VND in Cell A and 12,396,200.00 VND in Cell B. Return of investment (ROI) was 22.85% from Cell A which is 10-fold greater than that from Cell B (2.14%). This study shows that IPRS is a great aquaculture technology but fish farmers must follow all principles in order to maximize profitability and efficiency using the approach.

Grass carp (*Ctenopharyngodon idella*) is one of important aquaculture freshwater fish species in the Red River Delta, Vietnam. Since IPRS was introduced by USSEC, over 200 raceways have been built and adopted in Vietnam to produce various fish specie, including grass carp. This case study was conducted at the 2-raceway IPRS farm located in Duy Tien District, Hà Nam Province, Vietnam (Red River Delta Region)

in 2020. The main objective was to evaluate the productivity and profitability of grass carp production using IPRS technology.

### Materials and Method

- **Farm conditions:** The IPRS farm used in this study was built based on the design of raceway (2m length of upstream WWU connection x 25m of production zone x 3m quiescent zone), and its device meets the standard which includes sufficient water volume, WhiteWater Units, waste collecting system and air supplementary system.
- **Fingerling:** 5,120 grass carp with the average size of 1,100 grams were stocked into Cell A by December 16, 2019 and 5,500 grass carps with the average size of 750 grams were stocked into Cell B by February 11, 2020.
- **Feed:** Commercial feed with 31% crude protein and 8% fat used to feed daily twice for both cells according to the demand.

### Result and Discussion

- **Productivity:** Cell A was harvested by May 14, 2020 with total biomass of 14.467 mt, yielding 57.87kg/m<sup>3</sup>. Fish grew from 1,100 g to 3,150 g after 150 culturing days, ADG 13,67 g, survival rate 89.97% and FCR 2.0.

Cell B, total biomass at harvest time was 12.342 mt (48.4kg/m<sup>3</sup>) on August 25, 2020. Fish grew from 750 g to 2,750 g after 189 culturing days with ADG 10.10 g, survival rate 81.6%, FCR 2.1 (Figure 122). The biomass in both cells is relatively low, especially in Cell B. Due to the shortage of advanced fingerlings, the farmer could not stock sufficiently with the number at the initial stocking. Moreover, the large size of grass carp juveniles from traditional earthen ponds which were transported and stocked in raceways were improperly handled and was the main cause of the relatively high mortality rate. In addition, quality variation in stock genetics might also have brought about the slow growth performance in Cell B (ADG 10.10g) compared to Cell A (ADG 12.67g).

- **Profitability:** Economic analysis showed that the net revenue was 134,549,285 VND from Cell A and 12,396,200 VND from Cell B. Net return of investments (ROI) were 22.85% and 2.14% in Cell A and Cell B, respectively (Figure 123).

The ROIs were variable between the two cells — high in Cell A, but very low in Cell B. The key factor is system productivity that decides the profitability in aquaculture farming using IPRS technology. This suggests that farmers should initially stock optimal numbers of fish in IPRS raceways to obtain maximum productivity and profitability. In order to do that, IPRS farms must plan and follow standard design, management and operational principles.

#### Observations and Remarks

This is the first cycle of a new 2-raceway IPRS farm. The farmer was satisfied with the ROI from Cell A (22.85%), but was disappointed with the one from Cell B (2.14%). The farmer also understood that the non-uniform quality of fingerlings stocked in Cell B is the main reason for the lack of ROI. The farmer plans to prepare advanced fingerlings himself from his pond near the IPRS farm to ensure the quality and quantity in future cycles.

This study suggests that fish farmers are able to increase to a much higher productivity and profitability by optimizing stocking density with high quality of fingerlings.

**Figure 122.** Biomass, growth performance of grass carp in IPRS raceways in Ha Nam province, Vietnam

	Total biomass (kg)	Weight (g)	Survival Rate (%)	Culturing Days	ADG (g)	FCR
<b>Cell A</b>	14,514	3,150	89.7	150	13.67	2.0
<b>Cell B</b>	12,342	2,750	81.6	189	10.1	2.1

**Figure 123.** Itemized expenses, revenue and return of investment from grass carp production in IPRS farm in Ha Nam province, Vietnam

Itemized expenses	Cell A		Cell B	
	Amount (VND)	%	Amount (VND)	%
Fingerling	\$236,544,000.00	40.17	\$220,000,000.00	37.93
Feed	\$247,374,848.00	42.01	\$241,579,800.00	41.65
Electric	\$28,350,000.00	4.81	\$39,690,000.00	6.84
Labor	\$25,000,000.00	4.25	\$35,000,000.00	6.03
Depreciation	\$18,750,000.00	3.18	\$26,250,000.00	4.53
Consumable	\$12,500,000.00	2.12	\$17,500,000.00	3.02
Interest	\$10,416,666.67	1.77	\$12,833,333.33	2.21
Land usage	\$9,856,000.00	1.67	\$14,583,333.33	2.51
<b>Total expenses</b>	<b>\$588,791,514.67</b>		<b>\$580,019,800.00</b>	
<b>Total revenue</b>	<b>\$723,340,800.00</b>		<b>\$592,416,000.00</b>	
<b>Net revenue</b>	<b>\$134,549,285.33</b>		<b>\$12,396,200.00</b>	
ROI		22.85		2.14

## SECTION 8.4: Case Study: China

# U.S. Soy Industry Promotes the Sustainable Development of Global Aquaculture: China Experience

**Report Preparation Date:** 2021, Trial date:  
2018-2020

**Author:** Zhou Enhua (Technical Manager),  
U.S. Soybean Export Council (USSEC)

**Location:** Shanghai, China

### Introduction

China is the largest aquaculture producer in the world. In the past several decades, China's aquaculture production has accounted for more than 60% of the total global production. According to the China Fishery Statistical Yearbook, in 2020, China's total output of aquatic products was 65.49 million tons, and the proportion of aquaculture and capture was 80% and 20%, respectively. Total aquaculture production was 52.24 million tons, of which the output of freshwater and mariculture was 30.89 million tons and 21.35 million tons, respectively.

China is trying to move from a large aquaculture country to an environmentally sustainable and economically powerful aquaculture country. The production of healthy and safe aquatic products will directly determine the status and position of China's aquaculture industry in the world. Therefore, there is an urgent need to optimize and upgrade traditional aquaculture practices and adopt modern and scientific data driven technology. To achieve these specific goals and tasks, the "Five Actions" of green and sustainable aquaculture have been implemented all over the country beginning in 2020.

The focus has been on demonstration and promotion of ecologically sound and healthy aquaculture technology models. The IPRS technology ranks very high among the advanced aquaculture technologies in China.

For the future fishery advancement plan, China's fishery authorities have formulated several clear development objectives and tasks. By 2022, significant progress is sought in the development of "green and sustainable" aquaculture.

### Progress goals include:

- Improvements and optimization of aquaculture production structures
- Advancement or completion of technology transformation and upgrades
- Principal satisfaction of consumer demand for high-quality aquatic products
- Advanced establishment of ecologically and esthetically pleasing aquaculture systems
- Main aquaculture production areas meeting established water quality discharge standards
- Establishment of:
  - 500+ germplasm resource protection zones
  - 7,000 national healthy aquaculture demonstration farms

- 50 healthy aquaculture demonstration counties
- 98% qualification rate of sampling and inspection of aquatic product at the origin at 65% of the healthy aquaculture demonstration areas

By 2035, the aquaculture production structures will become more scientific and environmentally sustainable with sound supervision and oversight. Using first class equipment and advanced technology, any water discharge from aquaculture ponds will meet the established discharge standards and yield high-quality products, in an environmentally balanced aquaculture environment.

USSEC has implemented aquaculture projects in China for more than 30 years. We have successfully promoted the Low Volume and High-Density Cage Culture technology (LVHD) and 80:20 Pond Technology which were broadly popular and recognized by the Chinese fish farmers and aquaculture industry.

USSEC and China have always endeavored to keep pace with science, technology, constantly innovating, developing and promoting new aquaculture technologies to help broadly establish environmentally sound and sustainable aquaculture development in the country. USSEC has established a close technical cooperation with Auburn University for many years and jointly carried out the technical research of In-Pond Raceway System (IPRS). In the early days, it was called Intensive Pond Aquaculture (IPA). The IPRS technology was originally developed in the U.S. to improve the culture efficiency of channel catfish. The technology has been developed as a new pond aquaculture model to improve the survival rate of cultured fish, feed conversion rate, economic benefit and reduce labor and other fixed and variable costs. After several years of research and trials, USSEC introduced the IPRS technology into China in 2013. They developed technical improvements and innovations in design and operational management of IPRS according to the specific situation of China's existing freshwater aquaculture status. This evolution allows a better fit with China's existing environmental conditions, culture species, market demand and economic circumstances. At present, IPRS technology has been widely promoted and applied with great success across more than 20 provinces and cities within China. More than 7,000 standard IPRS raceways have been built and are operational in 2021. At the same time, IPRS technology is also being tested in brackish waters to culture Japanese seabass near Ninghai, Zhejiang Province.

**The IPRS technology has remarkable technical characteristics, which are:**

- Resource-saving
- Environment-friendly
- Advanced technology
- Intensive production
- Easy operation
- Controllable and manageable approach
- Product safety and benefit multiplication

Because cultured fish are living in high dissolved oxygen and flowing water all the time, fish yield and survival rate are greatly improved. These conditions also reduce the outbreak of fish diseases and the frequency of medication to ensure the safety of aquatic products. Thirdly, it can effectively reduce labor costs and improve labor efficiency. In the promotion of IPRS technology, through years of exploration and practice, we have made several significant equipment improvements as well as standardization.

**We have developed automatic sewage suction devices to:**

- Reduce the pollution of aquaculture water environment
- Achieve zero water discharge through proper water treatment technology
- Promote the green and sustainable development of the aquaculture industry in China

Now, USSEC is transferring and promoting the IPRS technology in other regions.

**Key IPRS Components and Considerations**

IPRS is a systematic and relatively comprehensive technology that incorporates fish containment, automated feed delivery, solid waste removal, improved aeration and water circulation and appropriate back-up contingencies. These components and devices are critical to ensure the smooth operation of IPRS and achieve better production performance. Key technical points of IPRS components and considerations are summarized as follows:

- **Selection and renovation of old ponds for IPRS:** First, we recommend the farmers choose a site with a sufficient water source, no pollution, reliable electricity supply and convenient transportation to build IPRS raceways. The total area of ponds for implementing IPRS should be no less than 25 to 30 mu (about 2 ha). Otherwise the investment cost per unit is increased. The orientation of the pond should also consider whether it is conducive to the wind stirring the normal water flow at surface, to reduce the energy consumption of the oxygenation and water moving equipment. During the renovation of an old pond, the excessive silt and earthwork shall be completely removed. At the same time, it shall be considered that the top surface of the pond ridge has a certain width, generally 3 to 5 m, and the slope ratio of the pond ridge is 1:1.5-3.0, which depends on the soil quality, depth and slope protection of the pond.





If conditions and funding permit, pond bank erosion control measures will ensure that the pond can be used year after year without draining the pond for desilting and maintenance. At present, the commonly used slope protection materials include cement precast slabs, concrete, impervious membranes, etc. After the renovation, it is necessary to ensure that the pond is watertight and the water depth is maintained at 2.0 m throughout the year, because the unit yield of each IPRS raceway is closely related to the water depth.

- Design and construction of IPRS raceways:** Considering the convenient installation and production operation of IPRS equipment, we usually encourage farmers to construct the raceways at the end of the long ridge of the large pond. The materials for the construction of IPRS raceways shall be selected according to the existing local resources and local conditions. The main materials include reinforced concrete, bricks, cement, FRP and stainless steel sheet. The standard raceway for fish culture is rectangular, with a length of 22 meters, a width of 5 meters and a height of 2.0 to 2.5 meters. In the IPRS design, the recommended area ratio of raceways to large open pond is generally controlled within the range of 2.0 to 3.0% but can be adjusted according to different fish species and designed fish biomass in each raceway. In other words, each standard IPRS raceway needs 10,000 cubic meters of quality water from the open pond to support the successful operation of the system. However, it was common to overbuild.

**Figure 124.** Renovation of old ponds for IPRS construction



**Figure 125.** Design and construction of IPRS raceways

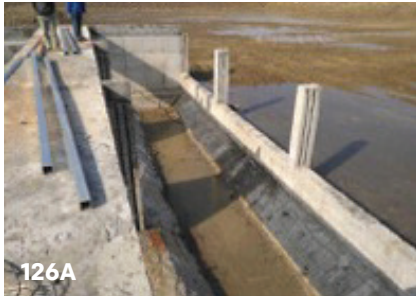


IPRS raceways that exceeded these recommendations and seriously affected the normal operation of the whole system. We strongly suggest that farmers should build the raceways according to the recommended proportion and not exceed the recommended proportion (Figure 126A & B.)

- Design and construction of Quiescent Zone (QZ) for fish waste collection and removal:** The QZ is a common area oriented at 90 degrees from the axis of IPRS cells that spans all raceways. Early IPRS designs included a 3-meter long QZ, but experience and technical improvements have

demonstrated that having 6 meter long QZ divided by a short wall of 30 cm and 50 cm to 60 cm knee wall (depending on water depth) at the downstream end improved the waste settlement and collection by 15% to 20%. The bottom of the QZ shall be flat at the same level as the bottom of the raceways without any slope or subsidence (Figure 126B). We have found that some farmers failed to design and build the QZ with a flat bottom according to our technical guidelines, which seriously affected the sedimentation and collection efficiency of fish wastes and led to the decline of comprehensive benefits of IPRS operation in early days (See Figure 126A & B.)

**Figure 126A & B.** Design and Construction of IPRS QZ (3m old designs, now replaced with more efficient 6m design)



- Design and improvement of fish waste collection and removal devices:** The fish wastes were removed manually when we conducted the first IPRS demonstration in 2013. Now, we have designed and manufactured the semi-automatic and fully automatic fish waste removal devices with traction monorail and double rails which are commonly used for IPRS operations in China. The solids collected from the IPRS QZ through proper settling and separation of solids from effluent can be directly and indirectly used for different crops and vegetables as high-efficiency organic fertilizer. Then the wastewater can be treated by sedimentation, aerated and reused by aquatic plants grown in an artificial wetland or aquaponics system. When the water quality reaches the aquaculture standard, it can be recycled or reused in the large open pond year after year.

At present, we have found that there are some serious defects in the design of sewage suction devices in some IPRS equipment enterprises which need to be modified to improve the waste collection efficiency. As we have recommended earlier, we should adopt the double sewage collection and removal system (6 m QZ), because the double sewage collection and removal device can greatly improve the efficiency of sewage removal and reduce the emissions of nitrogen, phosphorus and COD etc. (See Figure 127).

**Key considerations and tips for improving fish wastes collection and removal from the IPRS system:**

- Utilize 6 m QZ
- Use well-designed waste collection and removal device
- Control the water flow rate depending on fish species, size and biomass in the raceway
- Control waste collection and removal time and frequency depending on fish species, fish size, water temperature and feeding ration etc.
- Prevent any fish from entering the QZ

- Design and construction of fish waste sedimentation tanks:** In China, it is usually recommended that farmers construct 3 tanks near the IPRS facilities for fish waste treatment (Figure 128). The first two tanks are normally used for separation of solids and water and the third one for biological processing. The solids, which are removed periodically from the tanks with screw-type pumps, can be directly and indirectly used for agricultural crops and plants. The dimension of sedimentation tanks depends on the IPRS scale and space availability on the farm.

**Figure 128.** Early design of fish waste sedimentation tanks fixed in the pond; onshore designs are more efficient to operate



**Figure 127.** IPRS automatic double suction device (6 m QZ, new design)



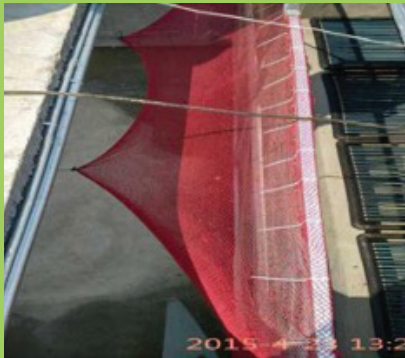
- Design and installation of fish fence:** The IPRS raceway is generally fenced at both upstream and downstream ends by stainless steel frames with galvanized wire mesh, plastic coated iron wire mesh or plastic mesh. The stainless steel frame and mesh are most commonly recommended and used in China. Considering the firmness and durability of IPRS fish fence mesh, we recommend that you use Model 304 stainless steel frame and mesh (Figure 129).

The mesh hole size should be determined according to the different fish species and size. Remember, the shape of the fish body will determine mesh size and we are trying to hold the smallest fish in the total population stocked. Double slots are usually designed at the upstream and downstream of the raceways to facilitate the replacement and maintenance of fish fence with different mesh sizes during the operation. The spacing between the two adjacent slots should be 20-30 cm. It is not good to have the spacing too narrow or too wide. In addition, the space between the raceway slots and the fish fence frame shall be considered to prevent fish from escaping. We normally recommend farmers to use a soft net as a bumper to reduce the physical damage of newly stocked fingerlings from bumping against the stainless steel mesh. Based on our years of experience and practice, the survival of newly stocked fingerlings can be significantly improved by using the soft net bumper (See Figure 130).

**Figure 129.** Stainless steel fish fence for IPRS operation



**Figure 130.** Soft net as a bumper for the newly stocked fingerlings



- Airlift WhiteWater Units:** The airlift WWU is the heart of an IPRS and often determines the success or failure of an operation. (Figure 131). The air supply to the WWUs can be centralized, where multiple WWUs share a common air supply, or each WWU can have its own blower. This design choice is often the result of the scale of the operation. Special attention should be paid to the selection and matching of the blower and aeration hose. Proper sizing and maintenance of the blower and diffuser hose will ensure long life and efficient operation of the WWU. Conversely, improper selection and maintenance can lead to malfunctions and loss of the fish crop.

Section 5.1 describes proper maintenance of the blower and diffuser hose. We recommend the Aero tube diffuser pipe produced in the United States with a standard air capacity of 2.25 m<sup>3</sup>/h/m.

The water flow regulation in IPRS raceways is one of the key control points for fish culture. Theoretically, the oxygen consumption per unit time can be calculated according to the volume and fish carrying capacity of the raceway and the oxygen consumption of different fish species at various temperatures and life stages. This information can be instrumental in determining the proper water flow through the raceway. The greater and faster the flow rate, the higher the dissolved oxygen in the water, resulting in greater fish production potential. This information is important in determining the correct flow rate or rate of water exchange in the raceway. The flow rate established by IPRS principles in this manual, 8-10 cm/sec, is appropriate for both maintaining healthy levels of dissolved oxygen for fish in culture and removal of metabolic wastes.

**Figure 131.** WhiteWater Units for IPRS operation





For most Chinese carps at different life stages, we usually suggest that the water flow rate is controlled between 6 to 10 cm/s, and the water in the IPRS raceways should be changed every 3 to 5 minutes. However, these parameters mainly depend on the culture fish species and the total biomass in the raceway. Techniques for measuring the water flow in the raceway are described in Section 3.7.

- Supplementary bottom aeration device:** In addition to the independent air lift WWUs installed at the upstream of each raceway, supplementary aeration should be installed at the bottom of each IPRS raceway for use when necessary (Figure 132A & B.) The supplementary aeration not only provides additional aeration during peak production, but it also helps clean the raceway bottom. In addition, this aeration equipment provides oxygen necessary to avoid fish stress during disease prevention and treatment, with the legally approved chemicals, when the WWUs at the upstream end are turned off to achieve proper exposure to the therapy. Based on our years of practice, the supplementary aeration device is only installed for the first 15 meters of the production zone (PZ) and not the last 7 meters of the PZ. This is to avoid a negative impact (resuspension of solids) on the collection efficiency of fish metabolic wastes in the QZ. During the construction of IPRS raceways, we recommend that a groove be reserved at the top of each raceway for the installation of supplementary air pipes.

**Figure 132A & B.** Supplementary aeration device at IPRS raceway bottom



However, many farmers ignore this point when building the top of the raceways, thereby hindering the daily operation and management by workers.

In addition, WWUs should also be installed and operated in the large open pond to ensure proper water mixing, flow and accelerate the decomposition of organic matter in the open pond. Continuous flow and mixing are particularly important because the recirculating flow of the water in the large open pond will directly affect the IPRS operational efficiency (Figure 133). The most common problem is that many farmers are not willing to run the WWUs in the open pond thinking they will save energy.

In reality, not using the additional WWUs leads to eutrophication of the water in the open pond, causing water quality problems that affect the survival rate, yield, FCR and ROI of the system. Therefore, it is suggested that farmers should pay more attention to the proper water mixing and aeration to ensure the positive recirculation of water quality in large open ponds to truly culture fish in small raceways and treat the open pond as a quality water source for the IPRS. We are also exploring the use of pure oxygen as a supplementary oxygenation approach, so as to further improve the output and ensure the reliability and safety of the IPRS operation in China.

**Figure 133.** Installation and operation of WWUs in open pond





- **Proper selection of blowers:**

There are many types of blowers available in China. At present, regenerative type blowers and lobe-type Roots blowers are commonly used for IPRS operation depending on its scale. (Figure 134A & B.) Long-term operation of the blower under the maximum ventilation resistance will reduce its service life and should not exceed 70% of its maximum working pressure. Select the corresponding blower according to the design scale of IPRS. Independent or separate air supply systems are usually adopted for small scale farms and large-scale IPRS farms can use a centralized air supply system. However, both air supply systems have advantages and disadvantages.

**Figure 134A & B.** Common blowers for IPRS operation in China



134A



134B

- **Design and construction of baffle:**

In China, the baffle is commonly made of soil/earth, PVC, stainless steel sheet, fine-mesh net, etc (see Figure 135). Construction materials that are locally available can help reduce construction costs, but they must be durable enough to provide service for several years so that the pond does not have to be drained thus ensuring uninterrupted production. To ensure resistance free circulation of the pond water the opening between the baffle and the pond wall should be at least 2-3 times of the total width of raceways. In addition, WWUs should be installed at the opposite corners to enhance the flow (Figure 135). Many farmers do not understand the importance and necessity of the baffle to ensure that the whole pond volume can function as a biofilter for the raceways.

**Figure 135.** Baffles for IPRS operation



- **Backup electricity generator:**

An auto-start backup generator is essential equipment for IPRS operations (Figure 136). Any interruption in power can and has resulted in serious mortality events. We always remind farmers to test the backup electricity generator regularly (in non-emergency situations) during the production cycle to ensure that everything works properly.

**Figure 136.** Auto-start backup electricity generator for IPRS operation



- **Auto-monitoring and alarm devices:**

The auto-monitoring and alarm devices ensure safe and reliable operation, high yield and high efficiency, and greatly reduce the production cost and risks. We developed and manufactured a series of auto monitoring and alarm systems for IPRS farmers in China (Figure 137). Using technology, we can monitor the different water quality parameters such as dissolved oxygen, water temperature, pH, ammonia nitrogen, nitrite, atmospheric pressure and the operational status of different equipment. This makes IPRS operation more controllable, predictable and manageable for the farmers who have adopted the USSEC IPRS technology in China.

**Figure 137.** Auto monitoring and alarm system for IPRS operation



Since 2013 when the USSEC IPRS technology was introduced to China, we have conducted a number of feeding trials to demonstrate the technical and economic feasibilities of USSEC IPRS technology for culturing different species of Chinese carps, tilapia, pangasius and channel catfish etc. at different provinces and cities in China. Some of the USSEC/China IPRS trial results are shared for your reference:

## Grass Carp

Grass carp is the number one freshwater fed fish species in China, and its total production was 5.57 million tons in 2020. Since grass carp is a typical herbivorous species, it has a very high utilization efficiency of soy products in the diet and the average inclusion rate of soybean meal could be as high as 40% to 55% in the USSEC grass carp diet formulation.

The USSEC IPRS technology was first introduced and demonstrated in 2013 to address the major constraints such as increasingly limited water and land resources, food safety, low productivity and profitability for sustainable aquaculture development in China. After successful trials demonstrating IPRS technology, additional assessments were conducted by the USSEC/China aquaculture program in collaboration with provincial and local fisheries, extension centers and aquaculture farms. Further, evaluations were conducted to show the technical and economic feasibility of using IPRS technology for culturing grass carp and other fish species with U.S. Soy-based diets.

### IPRS Grass Carp Grow-out Trials Trial Protocols

USSEC conducted an IPRS trial to demonstrate grass carp production from fingerlings to grow-out using the soy-based feed at one commercial IPRS farm in Anhui Province. The raceway cell is 22 meters in length and 5 meters in width. The average operating water depth is 1.7 m. The raceway cell was equipped with the air-lift WhiteWater Unit (WWU) at the upstream end for creating a constant water flow with high dissolved oxygen. The full pond was subdivided by an earthen baffle to allow full circulation of the water flowing through the raceways and around the entire pond before re-entering the cells. Silver and bighead carps were stocked as service species in the open pond to help improve water quality.

Grass carp fingerlings were stocked at a density of 12,000 fish per cell with an average size of 760 g/fish. The fingerlings were stocked in April and fed with the USSEC formulated 32/3 (crude protein/crude fat) U.S. Soy-based feed three times per day. All feed used in the trial was extruded, floating pellet form. The feed was produced by a company in Zhejiang Province, based on USSEC formulation specifications and with USSEC technical support.

Settled fish waste was collected 4-5 times daily by using vacuum pump operated in the QZ. The selected feeding trial in-pond raceway was treated with approved chemicals for parasite and disease control. Fish were sampled monthly to monitor growth and FCR. Data on fish survival, gross and net production, average fish weight and feed conversion efficiency were obtained at a full harvest. Data on production input costs was recorded in the USSEC data report throughout the trial to allow analysis and evaluate fish growth and economic return.

### Trial Results

The IPRS grass carp feeding trial with the U.S. Soy-based feed lasted 162 days. Grass carp fed with the U.S. Soy-based feed grew from 760 g to 2,369 g at the harvest. The total fish harvest weight of grass carp was 27,520 kg per cell with an average harvest biomass yield of 147 kg/m<sup>2</sup>. The FCR across the demonstration was 1.52:1.0. The average survival rate of grass carp in the trial was 96.8%.

The USSEC IPRS trial with grass carp fed the USSEC formulated 32/3 soy-based diet yielded a return of investment (ROI) of 27.7%. The economic analysis and return are shown as follows (See Figure 138).

Figure 138.

Inputs	RMB	USD	% of Total
Fingerlings	32,800	4,842	13.7
Feed	119,240	17,600	50.0
Labor	6,750	997	2.8
Electricity	5,390	796	2.3
Chemicals	500	74	0.2
Pond rent	5,000	739	2.1
Depreciation	69,000	10,185	28.9
Total costs	238,680	35,233	
Net income	66,114	9,759	
ROI	27.7	27.7	

### Summary and Discussion

The first USSEC IPRS technology trial with grass carp and the U.S. Soy-based diet was successfully conducted in Anhui Province, China. The farmer has achieved the production target as we designed and expected because he strictly followed our IPRS technical protocols and guidelines. The U.S. Soy-based feed showed the advantages for grass carp production in the IPRS compared to conventional or traditional pond production. More IPRS feeding trials will be conducted with grass carp and other freshwater fish species to expand the use of U.S. Soy-based feeds for sustainable aquaculture development in China in the future.

### IPRS Grass Carp Grow-out and Fingerling Trials

The U.S. Soybean Export Council (USSEC), in partnership with a technology extension center, continued the grass carp feeding trial after the success of the first growout trial. The objectives were to demonstrate and evaluate grass carp feeding performance using extruded floating feed, and to evaluate grass carp growth and economic performance at different life stages (fingerling) with 32/3 (protein/fat) extruded soy-based feed (see diet formulations

in Appendix J), using the USSEC IPRS technology which was newly introduced and promoted in China.

### Trial Protocols

Two IPRS cells having USSEC standard dimensions were used for the grass carp fingerling feeding trial. Pond water depth averaged approximately 2.0 m. The total water volume was 220 m<sup>3</sup> per cell. Cells 1 and Cell 2 were used for grow-out and large-size fingerlings (stockers). Grass carp fingerlings of 750 g each were stocked in Cell 1 at a density of 12,000 fish/cell and grass carp of 100 g each were stocked in Cell 2 at a density of 15,000 fish/cell. The trial fish in each IPRS cell were of uniform size and age at stocking. Target harvest size for the grass carp was 2.7 kg and 1.3 kg per fish in Cells 1 and Cell 2, respectively.

The grass carp were fed the USSEC formulated 32/3 soy-based grass carp grow-out feed adjusted for size of fish (see diet formulations in Appendix J). This feed was in extruded, floating pellet form. Grass carp were fed three times daily using the USSEC 90% satiation feeding technique. The feed was formulated by USSEC and produced by the Ningbo Techbank Feed Company, Zhejiang Province with USSEC providing technical guidance.

The trial fish in both IPRS cells were sampled approximately once per month. At the conclusion of the trial, the grass carp in each IPRS cell were counted and weighed to determine average fish weight, gross and net production, feed conversion ratio (FCR) and survival. Production input costs were recorded throughout the trial and net income and return on investment (ROI) were calculated at the end of the IPRS trial.

### Trial Results

The IPRS grass carp stocker development trial lasted 182 days. Grass carp in Cell 1 grew from 750 g to 2,880 g and the total production at harvest was 34,298 kg/cell, with an average biomass yield of 156 kg/m<sup>3</sup>. The survival rate was 99% and the feed conversion ratio (FCR) was 1.52:1 for grass carp grow-out production. Grass carp in Cell 2 grew from 100 g to 1,400 g and the total biomass at harvest was 20,864 kg/cell. The average biomass yield in Cell 2 was 95 kg/m<sup>3</sup> for grass carp fingerling production. The survival rate in this trial was also as high at 99% and the feed conversion ratio (FCR) was 1.49:1, using the USSEC IPRS technology.

The IPRS grass carp grow-out trial yielded a net economic income of RMB 79,248 (\$11,698 USD) and RMB 19,948 (\$2,944 USD) in Cells 1 and Cell 2, respectively. The return on investment (ROI) was 40.3% and 11.2% for grass carp grow-out production in Cell 1 and large-size fingerling production in Cell 2, respectively. The details of economic analysis and return for the IPRS grass carp grow out and large-size fingerling trial were shown as follows (See Figure 139).



**Figure 139.**

Input	Treatment 1 - Grow-out			Treatment 2 - Fingerling		
	RMB	USD	%	RMB	USD	%
Fingerlings	48,000	7,085	24.4	52,500	7,750	29.5
Feed	83,969	12,394	42.7	60,932	8,994	34.2
Labor	12,500	1,846	6.4	12,500	1,846	7.0
Electricity	3,927	580	2.0	3,927	580	2.2
Chemicals	750	111	0.4	750	111	0.4
Pond rent	5,000	739	2.5	5,000	739	2.8
Depreciation	42,500	6,274	21.6	42,500	6,274	23.9
Total cost	196,646	29,029		178,109	26,294	
Net income	79,248	11,698		19,948	2,944	
ROI (%)	40.3	40.3		11.2	11.2	

**Summary and Discussion**

This IPRS trial showed that it is both technically and economically viable to culture grass carp fingerlings and food fish using the USSEC IPRS technology and the USSEC formulated 32/3 U.S. Soy-based diet. The IPRS has greatly improved the survival rate of grass carp at both fingerling and grow-out production stages because fish are living in a quality water environment with constant flow and high dissolved oxygen. Use of chemicals and drugs has been significantly reduced to ensure better quality of fish products for consumers. Further, there is no need to drain the pond for harvest and the water can be recirculated and reused for many years to minimize carbon and organic discharge from aquaculture businesses in the future (see Figure 135).

In conclusion, this multiple-year trial demonstrates that it is advantageous to adopt the USSEC IPRS technology using U.S. Soy-based diets. These trials demonstrate that it is possible to conserve land, water, energy and other resources, while minimizing the use chemicals and drugs, reduce labor intensity and achieve higher production and better ROI compared to the traditional pond culture system.

**Figure 140.** USSEC IPRS grass carp trial in Anhui Province



**Figure 141.** Grass carp produced using the USSEC IPRS Technology





## Tilapia

### Introduction

Tilapia is one of the most common fed fish species to be cultured globally. The total production of tilapia in China was more than 1.65 million tons in 2020. Tilapia are a tropical species and are therefore predominantly cultured in the southern Provinces of China. The U.S. Soybean Export Council (USSEC) conducted the first IPRS tilapia trial with a two cycle per year production model, in collaboration with Guangxi Kangjialong Agricultural and Animal Husbandry Group in Guangxi Province. The objectives of this trial were to demonstrate the technical feasibility and evaluate capability and profitability of culturing tilapia with two cycles a year production model by using the USSEC IPRS technology in southern China. More broadly, it also seeks to expand the market window of U.S. Soy and establish a basis for increased use of U.S. Soy for aquaculture production in China.

### Trial Protocols

One IPRS farm unit established with three cells was constructed at one commercial aquaculture farm in Guangxi Province with technical support from the USSEC/China aqua staff in 2018. The raceway cell was 22 meters in length and 5 meters in width. The average operating water depth is 2.0 m. Two cells were used for the USSEC IPRS tilapia trial with a production model of two cycles a year.

- **First Cycle Trial:** Tilapia fingerlings with an average size 15.1 g and 22.7 g each were stocked at a density of 30,090 fish and 20,220 fish in Cells 1 and Cell 2, respectively. The target harvest size of tilapia was over 500 g in Cell 1 and 600 g in Cell 2.
- **Second Cycle Trial:** Advanced tilapia fingerlings (stockers) with an average size 256 g each were randomly stocked at a density of 13,500 fish and 17,000 fish in Cells 1 and Cell 2, respectively. In the second cycle Trial, the target harvest size of tilapia was over 500 g in both IPRS trial cells.

Silver carp and bighead were stocked as service species in the open pond to assist with water quality management.

Tilapia fingerlings were fed with the USSEC formulated 32/6 U.S. Soy-based feed (see diet formulations in Appendix J) 3 to 4 times per day depending on the fish size and weather conditions. All feed was in extruded, floating pellet form. The feed was produced by the Ningbo Techbank Feed Company, Zhejiang Province, and was developed based on USSEC formulation specifications and with USSEC technical support.

Settled fish wastes were collected and removed from the Quiescent Zone (QZ) 4 to 5 times daily using an electrically powered vacuum pump. The raceways used in this trial were periodically treated with approved chemicals for parasite and disease control. Fish were sampled monthly to monitor growth and FCR. Data on fish survival, gross and net production, average fish weight, and feed conversion efficiency were obtained at harvest.

All fish from the trial cells were counted and weighed at harvest to obtain the data. Data on production input costs was recorded in the USSEC data report maintained on-site throughout the trial to determine fish growth and economic return.

### Trial Results

- **First Cycle Trial:** After being fed with the USSEC formulated 32/6 U.S. Soy based diet (see diet formulations in Appendix) for 150 days, the tilapia had grown from 15.1 g to 518.5 g in Cell 1, and they grew from 22.7 g to 630.4 g in Cell 2. The total harvest biomass of tilapia for Cells 1 and Cell 2 was 15,051 kg and 12,282 kg with total biomass yields of 68.4 kg/m<sup>3</sup> and 55.8 kg/m<sup>3</sup> in Cells 1 and Cell 2, respectively. The survival rate was 96.8% and 96.4% and the feed conversion ratio was 0.98:1 and 1.05:1 in Cells 1 and Cell 2, respectively. The first cycle trial of tilapia in IPRS yielded a net income of RMB 25,512 (\$3,766 USD) and RMB 11,685 (\$1,724 USD), with a Return on Investment of 21.4% and 11.0%, in Cells 1 and 2, respectively.
- **Second Cycle Trial:** As a follow-on from Cycle 1, in Cycle 2 the tilapia grew from 256 g at stocking to 575 g in Cell 1 and the tilapia grew from 256 g to 581 g in Cell 2 after being fed with the USSEC formulated 32/6 U.S. Soy based diet for 61 days (see diet formulations in Appendix). The total harvest biomass of tilapia was 7,432 kg and 9,539 kg in Cells 1 and Cell 2 with total biomass yields of 33.7 kg/m<sup>3</sup> and 43.3 kg/m<sup>3</sup> for Cell 1 and Cell 2. The survival rate in the second cycle was 95.7% and 96.5% and the feed conversion ratio was 1.38:1 and 1.19:1 for Cells 1 and 2.

The second cycle of IPRS tilapia trial yielded a net income of RMB 2,242 (\$331 USD) and RMB 10,723 (\$1,853 USD), with a Return on Investment of 3.4% and 14.2%, in Cell 1 and Cell 2. The two-cycle IPRS tilapia trial lasted for a total of 211 days. The later part of Cycle 2 was entering cooler than optimal temperatures for feeding. The total harvest biomass of tilapia was 22,483 kg and 21,821 kg in Cell 1 and Cell 2 and the total net income was RMB 27,754 (\$4,097 USD) and RMB 22,408 (\$3,308 USD) in Cell 1 and Cell 2 (See Figure 142 and 143).

**Summary and Discussion**

The first USSEC IPRS tilapia trial with two cycles per year production model was successfully conducted in Guangxi Province, China. The trial results showed that it is technically and economically feasible to culture tilapia using the USSEC IPRS technology with two-cycle production per year model. However, the economic return of the tilapia trial was not as high as we expected because market price of tilapia like other freshwater fish species at the time of the trial was low in China. The stocking density could be increased considerably to yield higher fish production and economic returns in each cell if the farm had sufficient fingerling stock. It is recommended that the stocking size of tilapia fingerlings should be increased (30 g to 40 g) to meet with the target harvest size if multiple cycle production model is applied in the IPRS. More IPRS two-cycle trials with tilapia and other fish species fed the U.S. Soy-based diets will be conducted in southern China in the future.

**Figure 142.**

	Cell 1	Cell 2
Total fish production (kg)	22,483	21,821
Average survival (%)	96.1	96.5
FCR	1.18	1.12
Total net income (RMB)	27,754	22,408
Total net income (USD)*	4,097	3,308

**Figure 143.** USSEC IPRS Tilapia Trial in Guangxi, China



## Pangasius

### Introduction

The U.S. Soybean Export Council (USSEC), in cooperation with the Beijing Municipal Fisheries Technology Extension Center, conducted an IPRS pangasius feeding demonstration in Haikou City, Hainan Province. The objectives of this trial were to demonstrate technical feasibility and evaluate profitability of culturing pangasius using a two-cycle per year production model using the USSEC IPRS technology and U.S Soy-based diet in southern China. Moreover, it also expands the market window of U.S. Soy and creates more use for U.S. Soy in aquaculture production in China.

### Trial Protocols

One IPRS farm unit with three cells was constructed at the Hainan Breeding Center of the Beijing Municipal Fishery Extension Center with technical support from the USSEC/China aqua staff. The raceway cells were 22 meters in length and 5 meters in width. The average operating water depth is 2.0 m. Two cells were used for the USSEC IPRS pangasius trial with a two-cycle per year production model.

- **First Cycle Trial:** Pangasius fingerlings with an average size of 192 g each were stocked into Cell 1 and Cell 2 at a density of 40,000 fish/cell and 30,000 fish/cell. The target harvest size of pangasius was over 500 g and 600 g in Cells 1 and Cell 2.

- **Second Cycle Trial:** Pangasius fingerlings with an average size 505 g each were stocked at a density of 10,000 fish in Cell 1 and smaller pangasius fingerlings of 100 g each were stocked at a density of 30,000 fish in Cell 2. Cell 1 was used for pangasius grow-out production while Cell 2 was used for producing large-sized fingerlings (stockers) which would be utilized for food-fish production the following year. The target harvest size of pangasius was over 1,500 g and 500 g in Cells 1 and Cell 2.

Silver carp and bighead were stocked as service species in the open pond to assist with water quality management and improvement.

Pangasius fingerlings were fed with the USSEC formulated 28/4 U.S. Soy- based feed (see diet formulations in Appendix J) 3 to 4 times per day depending on the fish size and weather conditions. All feed used was in extruded, floating pellet form. The feed was produced by the Ningbo Techbank Feed Company, in Zhejiang Province, based on USSEC formulation specifications and with USSEC technical support.

Settled fish wastes were collected and removed from the QZ 4 to 5 times daily by an electrically powered vacuum pump. The feeding trial in-pond raceways were periodically treated with approved chemicals for parasite and disease control. Fish were sampled monthly to monitor growth and FCR.

Data describing fish survival, gross and net production, average fish weight and feed conversion efficiency were obtained at harvest. All fish from the trial cell were counted and weighed at harvest to obtain the data. Data on production input costs was recorded in the USSEC data report throughout the trial to determine the fish growth and economic return.

### Trial Results

- **First Cycle Trial:** Beginning April 28 to August 28, 2019, the pangasius were fed for 120 days using the USSEC formulated 28/4 crude protein/crude fat diet (see diet formulations in Appendix J). During this period, the pangasius grew from 192 g to an average of 505.6 g in Cell 1 and from 192 g to 603 g in Cell 2.

The total harvest biomass of the pangasius was 18,523 kg and 16,493 kg with total biomass yields of 84.2 kg/m<sup>3</sup> and 75 kg/m<sup>3</sup> in Cell 1 and Cell 2, respectively. The survival rate was 92.0% and 91.0% and the feed conversion ratio was 1.30:1 and 1.20:1 in Cell 1 and Cell 2, respectively. With the market price to the farm of RMB 8/kg, the first cycle of IPRS pangasius trial yielded a net income of RMB 44,607 (\$6,585 USD) and RMB 36,867 (\$5,442 USD), with a Return on Investment of 40.8% and 36.6%, in Cell 1 and Cell 2.



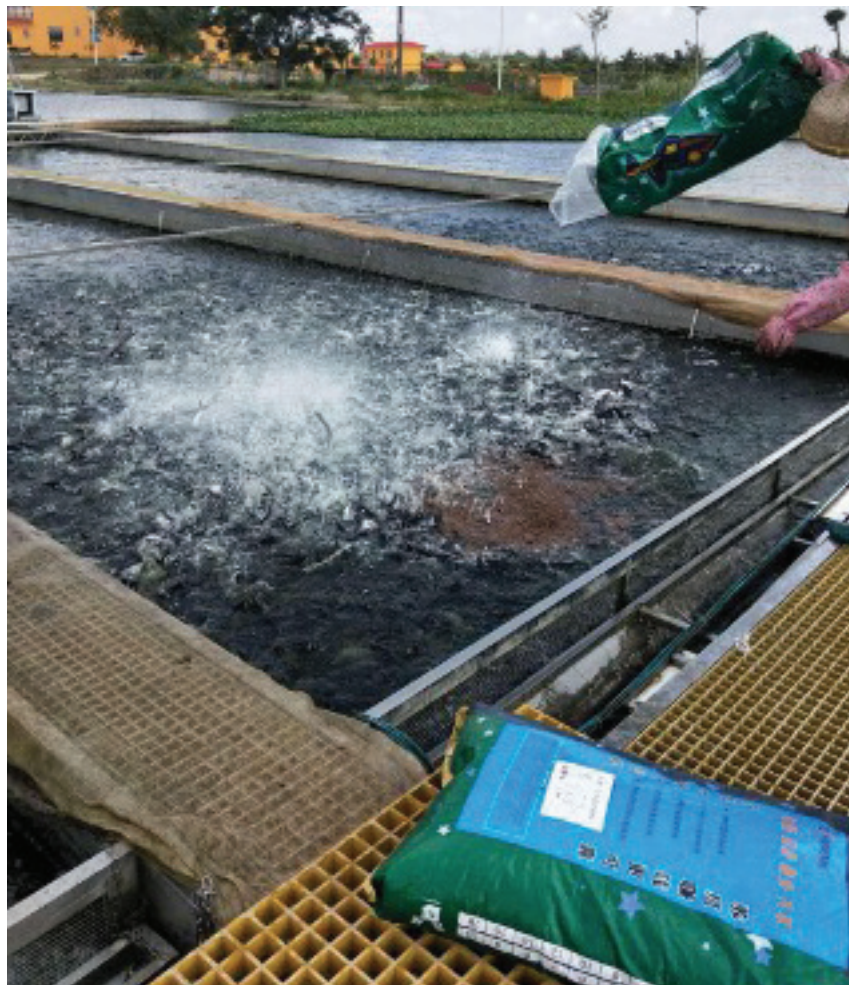
- **Second Cycle Trial:** The pangasius in Cell 1 were fed with the USSEC formulated 28/4 U.S. Soy-based diet (see diet formulations in Appendix J) for 111 more days and grew from 505 g to 1,620 g. Cell 2 was stocked with 100 g fish that grew to 515 g. All the fish produced in Cell 2 would be used in follow-on trials as large-sized fingerlings for the next year's production. The total harvest biomass of pangasius was 15,989 kg and 14,059 kg with biomass yields of 72.7 kg/m<sup>3</sup> and 63.9 kg/m<sup>3</sup> in Cell 1 and Cell 2.

The survival rate was 98.7% and 91.0% and the feed conversion ratio was 1.10:1 and 1.20:1 in Cells 1 and 2, respectively. The second cycle of the IPRS pangasius trial yielded a net income of RMB 39,061 (\$5,766 USD) and RMB 19,401 (\$2,864 USD), with a Return on Investment of 41.38% and 19.7%, for Cell 1 and Cell 2.

The two-cycle IPRS pangasius trial lasted for a total of 231 days. The total harvest biomass of pangasius of two cycles was 34,512 kg and 30,552 kg in Cell 1 and Cell 2. The total net income was RMB 83,668 (\$12,351 USD) and RMB 56,268 (\$8,306 USD) in Cells 1 and Cell 2, respectively (See Figures 145 and 146).

**More IPRS trials with pangasius and other fish species fed the U.S. Soy-based diets will be conducted in South China in the future to expand the market window of U.S. Soy for aquaculture feeds.**

**Figure 144.** USSEC IPRS pangasius trial with the USSEC formulated soy-based diet in Hainan Province, China





### Summary and Discussion

The first USSEC IPRS pangasius trial with two cycles per year production model was successfully conducted in Hainan Province, China. The trial results showed that it is technically and economically feasible to culture pangasius using the USSEC IPRS technology with a two-cycle per year production strategy using the USSEC formulated soy based diet. The farmers have achieved financially attractive trial results after correctly adopting and properly following the USSEC IPRS technical protocols and following guidelines from the USSEC aquaculture staff. Chemicals and antibiotics were not used during the trial period and there were no off-flavor issues for the fish produced in the IPRS trial cells. The economic efficiency could be even better if the market price of pangasius had been higher. More IPRS trials with pangasius and other fish species fed the U.S. Soy based diets will be conducted in South China in the future to expand the market window of U.S. Soy for aquaculture feeds.

**Figure 145.** Stocking and harvest details of USSEC pangasius trial with two-cycle production model per year in IPRS Cell 1 in Hainan, China

	First Cycle	Second Cycle
Water volume (m <sup>3</sup> )	220	220
Stocking size (g/fish)	192	505
Stocking density (fish/cell)	40,000	10,000
Total stocking wt. (kg/cell)	7,680	5050
Harvest size (g/fish)	505.6	1,620
Survival rate (%)	92.0	98.7
Fish production (kg/cell)	18,523	15,989
FCR	1.30	1.10
ROI (%)	40.85	41.38

**Figure 146.** Stocking and harvest details of USSEC pangasius trial with two-cycle production model per year in IPRS Cell 2 in Hainan, China

	First Cycle	Second Cycle
Water volume (m <sup>3</sup> )	220	220
Stocking size (g/fish)	192	100
Stocking density (fish/cell)	30,000	30,000
Total stocking wt. (kg/cell)	5,760	3,000
Harvest size (g/fish)	603	515
Survival rate(%)	91.0	91.0
Fish production (kg/cell)	16,493	14,059
FCR	1.20	1.20
ROI (%)	36.61	19.70

## SECTION 8.5: Case Study: Bangladesh

**Link to access CC cams:**

Download the NVSEE App

**Login:** bdrahat53@gmail.com

**Password:** asd@#\$bdt123A

# In-Pond Raceway Technology Demonstration-2021

**Report Preparation Date:** 2021-10-18

**Author:** R. Umakanth

**Location:** Natore, Bangladesh

### Introduction

Bangladesh has an increasing demand for efficiently grown aquatic animal proteins. An advanced aquaculture system like IPRS can enhance their capabilities to produce more fish in a sustainable manner. The Bangladesh aquaculture industry is expected to surpass 5 mmt production volume by 2021, and pond culture contributes to nearly 46% of this production volume. In Bangladesh, fish is by far the most consumed animal food source across all population groups (>50%), with a per capita fish consumption rate of nearly 19.71 kg (CGIAR). USSEC identified this market potential enhancement opportunity in Bangladesh and with Iowa Soybean Association support, USSEC took the initiative to organize an IPRS demonstration in Bangladesh.

### About the Demonstration

The farm USSEC worked with is one of the most highly regarded fish farms in Bangladesh. It was founded as a fishery farm, and was registered as a joint-stock and limited company and is the pioneer of technology-based fish farming in Bangladesh.

They have their own fish firm with a total land area of 25 acres and a total of 14 ponds inside it (See Figures 147A & B.)

USSEC spent time and funds in improving the knowledge and expertise of the selected partner about IPRS technology. USSEC exposed the selected partner to IPRS technology training in China during the year 2018, the selected partner also visited IPRS demonstration site in India during the year 2019 to learn more about IPRS technology.

**Figure 147A.** Aerial view of fish farm



**Figure 147B.** Partner visit to Indian IPRS demo site



USSEC also exposed the partner to a virtual IPRS training program organized by Progressus AgriSchool in Thailand in 2020.

### Site Selection

A 1.237 ha pond that belongs to the partner was selected for the construction of the IPRS at Natore, Bangladesh. Site verification was carried out in 2018. The USSEC advisory team provided basic IPRS structural design, which was adapted to selected demonstration site soil conditions based upon their civil engineering consultant's advice and guidance. Periodic observations and appropriate suggestions were provided during the construction process. Based on the pond dimensions, a 3-cell IPRS was suggested (See Figures 148A-C).

Complete structure is of concrete with 10-inch thick walls, and 10-inch thick concrete flooring was laid on the cell bottom and a 6-meter wide Quiescent Zone with concrete flooring was constructed (See Figures 149A & B.) All the bunds are covered with GEOTEX liner and the baffle was constructed with durable sheets. One-meter high knee walls on both ends of the cell were constructed and a concrete walkway at both ends of the cell was also constructed. A 6-meter long, 2-meter wide and 2-meter deep, three-chambered sludge recovery tank was also constructed adjacent to the IPRS cells. The complete IPRS civil structure is ready for equipment installation (See Figures 150A & B.) Three floating WhiteWater Units, each equipped with four aeration grids, deflection hood and a 3 p blower were installed with one in each cell. Three additional WhiteWater Units with above mentioned specifications were also installed in the open pond for oxygenation and water circulation (See Figures 151A & B.)

**Figure 148A – C.** Foundation & flooring work in progress



**Figure 149A & B.** Bunds covered with liner



**Figure 150A & B.** Raceway cells under construction



**Figure 151A & B.** Raceway cell and baffle wall





Bottom aeration for the emergency aeration system was also installed in all three cells and supported by a 4.3 hp air blower (See Figures 152A & B.)

Two 3-meter wide sludge recovery systems with suction pumps and rotation motors were installed in the 6-meter wide Quiescent Zone (See Figures 154A & B.)

A control panel with all the starters and control systems for the air blowers and sludge recovery system was installed near the feed storage room. Four security cameras were installed around the IPRS facility for security and monitoring purposes. Two 45 kV generators were installed as standby power support for the entire IPRS running load. Upon completion of all equipment installation and functional check, water pumping and water culture was initiated (See Figures 153A & B.)

**In consultation with USSEC aqua program technical representative and IPRS technology advisory team, the partner made the stocking plan as follows:**

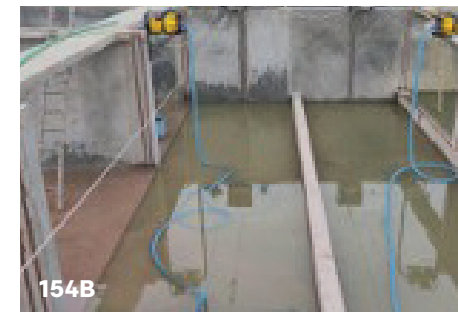
**Figure 152A & B.** Air lifts and bottom aeration system in place



**Figure 153A & B.** Completed raceways



**Figure 154A & B.** Settled solids recovery system





### Details of fish stocked in the raceway cells:

- **Cell 1**

- Culture Species: *Labeo rohita*
- Stocking number: 12,000 number fish (54.54 / m<sup>3</sup>)
- Stocking ABW: 200 gm
- Stocking Date: 2021-08-14

- **Cell 2**

- Culture Species: *Labeo rohita*
- Stocking number: 12,000 number fish (54.54/m<sup>3</sup>)
- Stocking ABW: 190 gm
- Stocking Date: 2021-08-16

- **Cell 3**

- Culture Species: *Ctenopharyngodon idella* (grass carp)
- Stocking number: 12,000 number fish (54.54/m<sup>3</sup>)
- Stocking ABW: 20 gm
- Stocking Date: 2021-08-26

### Open pond fish stocking details (service species):

- **Fish Species-1:**

#### ***Hypophthalmichthys molitrix* (silver carp)**

- Stocking number: 4,000 number fish
- Stocking ABW: 500 gm
- Stocking Date: 2021-08-16

**Figure 155A – C.** Filling the pond and system



- **Fish Species-2: *Labeo rohita* (rohu)**

- Stocking number: 900 number fish
- Stocking ABW: 200 gm
- Stocking Date: 2021-08-16

- **Fish Species-3: *Catla catla* (Catla)**

- Stocking number: 900 number fish
- Stocking ABW: 200 gm
- Stocking Date: 2021-08-16

With the support of the Wittaya Aqua team, USSEC provided the feed formulations required for IPRS feeding demonstration.

**Figure 156.** The feed formulations used for the demonstration are as follows:

**30/5 IMC Rohu Diet**

Ingredient Name	Ingredient Inclusion (%)
Soybean meal, U.S., 47% CP	42.83
Rice bran, defatted	23.26
Wheat, flour	24.90
Poultry by-product meal, 60% CP	5.00
Soy lecithin	1.00
Fish oil	1.62
Vitamin premix, USSEC standard, fish grower, 0.5%	0.50
Mineral premix, USSEC Standard, fish, 0.25%	0.25
L-lysine	0.02
DL-methionine	0.08
Choline chloride, 60% choline	0.10
Mold inhibitor (calcium propionate)	0.10
Mycotoxin binder (Mineral clay product: zeolites)	0.10
BHT, powder, 0.1%	0.10
Salt, NaCl	0.10
Rovimix-stay-C 35, ascorbyl-monophosphate	0.04
	<b>100.0</b>

**28/5 IMC Rohu Diet**

Ingredient Name	Ingredient Inclusion (%)
Soybean meal, U.S., 47% CP	39.82
Rice bran, defatted	30.00
Wheat, flour	22.20
Poultry by-product meal, 60% CP	3.00
Soy lecithin	1.66
Fish oil	1.27
Vitamin premix, USSEC standard, fish grower, 0.5%	0.50
Mineral premix, USSEC Standard, fish, 0.25%	0.25
Mono calcium phosphate, MCP, $\text{Ca}(\text{H}_2\text{PO}_4)_2 \cdot \text{H}_2\text{O}$	0.50
L-lysine	0.15
DL-methionine	0.12
Choline chloride, 60% choline	0.10
Mold inhibitor (calcium propionate)	0.10
Mycotoxin binder (Mineral clay product: zeolites)	0.10
BHT, powder, 0.1%	0.10
Salt, NaCl	0.10
Rovimix-stay-C 35, ascorbyl-monophosphate	0.04
	<b>100.0</b>

The partner followed USSEC's 90% satiation technique to feed the fish in the cells. Growth rate and health condition was monitored periodically.

**Figure 157.** First Sampling Report

Inputs	Cell 1 Rohu	Cell 2 Rohu	Cell 3 Grass Carp
Stocking date	2021-08-14	2021-08-16	2021-08-26
Stocking size	200 gm	190 gm	20 gm
Total stocking/cell	12,000	12,000	12,000
Soy-based extruded feed up to 2021-10-12	2749 kg	2684 kg	1018 kg
Current size of the fish 2021-10-13	440 gm	405 gm	120 gm
Growth attained	240 gm (59 days)	215 gm (57 days)	100 gm (47 days)
Growth/day	4.06 gm/day	3.77 gm/day	2.12 gm/day

With the support of a partner, USSEC organized an IPRS field day at the IPRS demo site on the 2021-09-28. More than 157 key aqua industry stakeholders from all over Bangladesh attended the program. IPRS technicalities, financials and advantages were clearly explained to all audiences through physical visit to the IPRS site, virtual and live presentations followed by a question and answer session.

**Figure 158A – F.**



158A



158B



158C



158D



158E



158F

## SECTION 8.6: Case Study: India

# In-Pond Raceway System Technology Demonstration

**Report Preparation Date:** 2018

**Author:** Umakanth Rand

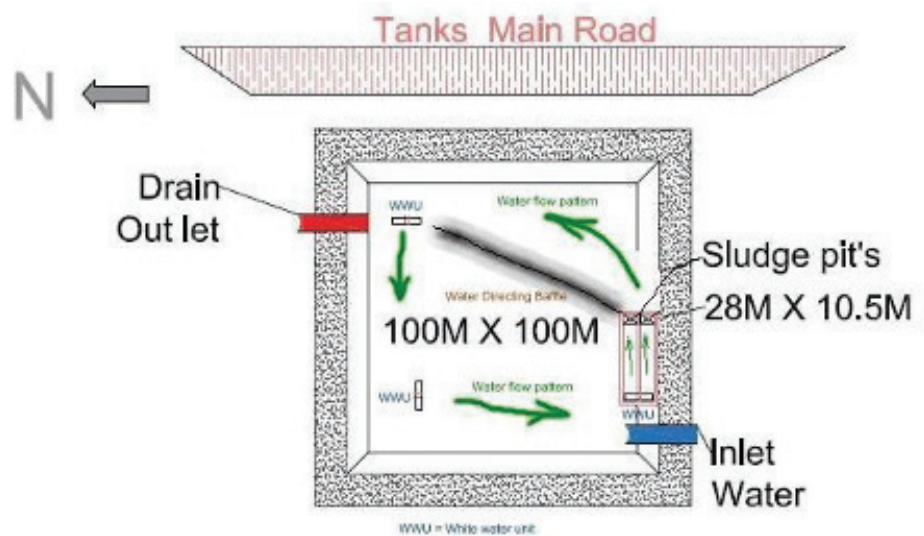
**Location:** LUSOT AQUA, Andhra Pradesh,  
India

In this Case Study, a local collaborating partner, with the technical support of USSEC, designed, constructed, operated and evaluated the technical and economic feasibility of IPRS at this site in India. Fish were fed a complete and balanced soy-optimized diet in this IPRS demonstration to optimize ROI and at the same time document its minimal environmental impact.

The partner selected the demo pond with 1 ha water spread area in Koduru Village near Gudivada town, Andhra Pradesh, India. With the consultations and suggestions from USSEC, they began to construct an IPRS in that pond. The entity planned to construct two cells in the selected 1 ha. demo pond on the southwestern side of the pond. Dimensions of each cell are 5 meters wide, 26.5 meters long and 2 meter deep (See Figure 159).

Concrete was used for the cell skeleton construction, and the side walls were constructed with brick. 4.6 mt of iron, 35.5 mt of cement, 22,500 bricks, 100 mt of sand, 20 mt of soil and masonry work totaling 3500 square feet was used for the construction of the IPRS. For the Quiescent Zone (QZ), they adapted a sludge pit model.

**Figure 159.**



They installed three stainless steel sludge pits in the Quiescent Zone to collect the solid waste which will be sucked out by three sludge pumps. All the sludge collected can be pumped into a settlement tank, and water will again be shifted back into the pond.

For the WhiteWater Unit, they used authentic Aero tubes. In total, they used nearly 460 meters of Aero-Tubes to prepare 5 WWUs, two of them were placed in the two IPRS cells and three more were placed in the open pond to maintain water current.

They used thick HDPE sheets supported by wooden poles to create the baffle wall starting from the rim of the cell to the northeastern corner of the pond. They installed six blowers, three on the IPRS cells and three on the exterior WWUs.



In total, they purchased six blowers which were matching with the specifications suggested by USSEC consultants, each blower cost nearly \$625.

Protective screening mesh were used, two in front of the WWU and two on the other side of the cell before the QZ. At the QZ exit point, one more protective mesh system was in place. As a standby, a 45 kVA generator was in place.

After the completion of the construction process, a farmer gathering was organized, nearly 75 farmers and key aquaculture industry stakeholders across India visited the IPRS site. All the technical and financial aspects of the IPRS were shared with the farmers and clarifications were provided for their queries (See Figures 160A & B).

**Figure 160A & B.**



**Figure 161A & B.**



#### **Economics of IPRS Construction at the Demo Site**

- **Construction cost of main IPRS civil structure:** INR. 14,00,000 (\$21,875)
- **Stainless steel sludge pits & sludge pumps:** INR. 3,00,000 (\$4700)
- **WhiteWater Units:** INR. 3,20,000 (\$5,000)
- **Blowers:** INR. 2,40,000 (\$3,750)
- **Protective screening mesh:** INR. 2,56,000 (\$4,000)
- **Baffle:** INR. 64,000 (\$1,000)
- **Generator:** INR. 3,00,000 (\$4,700)
- **Pumping and other water flowline cost:** INR. 1,28,000 (\$2,000)

#### **TOTAL ESTIMATED ESTABLISHMENT COST OF IPR SYSTEM: \$46,650**

(See Figure 161A & B).

#### **Feeding Demonstration**

In 2018, the farm initiated the first culture cycle in the IPRS technology adapted pond. By following the USSEC specified pond preparation protocols, they prepared the pond for seed stocking. Two culture species were identified for culture and feeding demonstration in the IPRS demo pond, *L. rohita* and *P. brachypomus*.

After following all prophylactic measures and seed stocking protocols, 30,800 *L. rohita* seed was stocked in raceway cell one with an average body weight of 60 gms. In the second raceway cell, 28,000 *P. brachypomus* seed was stocked with an average body weight of 150 gm. In the unfed zone of the open pond, 3,000 *C. catla*, 75 gms size and 6,000 *L. rohita*, 60 gms size were stocked. Feed was produced with USSEC specified soy-based formulation. By following satiation feeding technique they fed the fish. Monthly sampling was conducted to measure the growth rate and to monitor the fish health. The partner followed all USSEC guidelines for managing the IPRS demo pond during the demo period. At the end of demonstration, fish were harvested from both the cells and from the unfed open pond area. Harvested biomass was measured from each cell and from the unfed open pond area. Based on the harvest biomass, volume of feed used for the demo and other management expenses ROI was estimated (See Figures 162 and 163).

**Figure 162.**

**Feeding Demonstration Details**

Details	Culture Species	# of Seed Stocked	Stocking Body Weight (g)	Stocking Biomass (kgs)	Harvested Body Weight (g)	Harvested Body Weight (kg)	Incremental Biomass (kg)	Feed Used (kg)	Survival (%)	FCR	DOC (days)
Cell-1	L. rohita	30,800	60	1848	700	19,404	17,556	31,600	90 %	1:1.8	240
Cell-2	P. brachypomus	28,000	150	4200	1000	25,200	21,000	36,750	90 %	1:1.75	210
Open pond	C. catla	3,000	75	225	1000	3000	2775	0	100%	1:0	240
Open pond	L. rohita	6,000	60	360	1000	6000	5640	0	100%	1:0	240
				6,633		53,604	46,971	68,350		1:1.45	

**Figure 163.**

**ROI**

	Seed Cost	Feed Cost	Other Management Cost	Total Cost for One Cycle	Revenue M L. rohita Sale	Revenue from P. brachypomus Sale	Revenue from C. catla Sale	Total Revenue	Profit Gain
INR	4,85,000	32,32,900	5,00,000	42,17,900	25,404 Kg X RS 95 = 24,13,380	25,200 Kg X Rs 100= 25,20,000	3000 Kg x Rs 95 = 2,85,000	52,18,380	10,00,480
U.S. dollars	\$6,719.85	\$32,198.48	\$11,084.29	\$58,440.55	\$33,438.26	\$34,915.52	\$3,948.77	\$72,302.56	\$13,862.01

**For more information about IPRS, contact [IPRS@ussec.org](mailto:IPRS@ussec.org).**

# APPENDIX

## **Appendix**

The purpose of this Appendix is to provide the reader with detailed information that was not placed in the main body of the manual. Because this information goes into more detail than in the main text, it was placed in the Appendix to provide a ready reference for the reader.

# APPENDIX A:

## Understanding Water Chemistry in Ponds

Operators of aquaculture pond systems should understand the chemistry impacting their ponds just like farmers who grow crops on soil. Like soils, water chemistry is highly variable from place to place. This chemistry is generally driven by water's association with various soil types. Contact between water and the soils across or over which the water has passed has a major bearing on its chemistry.

Several components dissolved in water drive chemical reactions which rule pond productivity, fish health and stress levels, availability of dissolved oxygen (DO), as well as toxicity of ammonia and certain metal ions. Most chemistry parameters we measure in water are not constant, they fluctuate or cycle daily. Good examples are the dynamics of dissolved oxygen (DO), carbon dioxide and pH. Alkalinity and hardness are relatively stable but can change over time, usually weeks to months depending on the pH or mineral content of the aquifer, watershed and pond bottom soils. To gain a better understanding of water chemistry, we need to know the various components which impact how they interact it.

### Dissolved Oxygen

As previously discussed, the first principle of IPRS is using flowing water to enhance management of oxygen in pond aquaculture. Refer to other sections of the manual (WhiteWater Units, Waste Extraction, Knowing Water Chemistry, Establishing a Healthy Phytoplankton Bloom, Water and Water Quality and Solids Removal System) for practical aspects related

to dissolved oxygen and fish waste products in IPRS.

Fish, like all animals, must obtain oxygen from the environment for respiration. Oxygen is far less available to aquatic organisms than it is to air-breathers, and the dissolved oxygen content of water may limit the activities of fish. In most natural waters, the supply of oxygen to water (diffusion from the atmosphere and production from underwater photosynthesis) exceeds the amount used in oxygen-consuming processes, and fish seldom have problems obtaining enough oxygen to meet normal metabolic demands. In aquaculture ponds, the biomass of plants, animals and microbes is much greater than in natural waters, so oxygen is sometimes consumed faster than it is replenished.

Depending on how low the dissolved oxygen concentration is and how long it remains low, fish may consume less feed, grow more slowly, convert feed less efficiently, be more susceptible to infectious diseases or suffocate and die. Operators of IPRS avoid these problems by continually mixing, aerating and moving pond waters to supplement oxygen supplies released from photosynthesis and at the same time reduce demand by pond biota. Without following the IPRS principles described here and using photosynthesis derived DO to our advantage, IPRS would produce no more biomass than traditional systems.

### Importance of Photosynthesis and Water Mixing, Aeration and Flow in IPRS ponds

IPRS ponds manage water volume of the pond differently from traditionally managed ponds. IPRS uses an approach which simulates natural

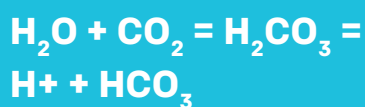
systems that use continually aerated and mixed flowing water as the basis for aquaculture pond production. As opposed to static, periodically aerated traditional ponds, IPRS uses continually aerated, flowing water to enhance the ability of the pond to assimilate organic loading and waste produced by feeding fish. The effect of the moving aerated water in the pond is to provide abundant oxygen to the pond assimilation organisms throughout the water column to accelerate waste breakdown. Because we are mixing oxygen-laden water, especially in daylight hours, the full water column and water volume of the pond becomes an oxygen storage vessel available for continual use by assimilators. Feeding rates and waste assimilation is driven by temperature and available DO. Whether in summer months of temperate climates or in warm tropical pond systems, continually flowing aerated water bringing abundant DO and organic materials together with assimilation biota, pond biological oxygen demand (BOD) and chemical oxygen demand (COD) are markedly reduced. Further, because fish are held in raceways equipped with a downstream Quiescent Zone (QZ), settled waste solids (manure, feed fines and organic particles) are collected, efficiently removed from the IPRS pond and re-tasked in many different agriculturally oriented ways. Operating IPRS according to all principles found to be essential to efficiency, reliability and predictability allows operators to significantly improve yield per cycle and annual ROI.

### pH and Carbon Dioxide

The pH measure indicates whether water is acidic or basic. More precisely, pH indicates the hydrogen ion concentration in the water.



Readers should note that the pH is reported in “logarithmic units”, that is, each number represents a 10-fold change in the acidity/alkalinity of the water. Water with a pH of 5 is 10 times as acidic as water having a pH of 6. Further, pH of 7 is considered neutral. Water is considered acidic when pH is below 7 and basic or alkaline when pH is above 7. Most pH values encountered in ponds fall between pH 5.5 and pH 10.5. At pH levels lower than 4.0 and higher than 11.0, fish typically die. The recommended pH range for aquaculture is 6.5 to 9.0. A more desirable range for pond water pH would be close to that of fish blood (i.e., 7.0 to 8.0). Fish may become stressed and die if the pH drops below 5 (e.g., acidic runoff) or rises above 10 (e.g., low alkalinity combined with intense photosynthesis by dense blooms of phytoplankton or filamentous algae). Pond pH varies throughout the day due to respiration and photosynthesis. After sunset, dissolved oxygen (DO) concentrations decline as photosynthesis stops and all plants and animals in the pond begin to consume oxygen (respiration). In heavily stocked and fed fishponds, carbon dioxide (CO<sub>2</sub>) concentrations can rise because of respiration by all biota. The free CO<sub>2</sub> released during respiration reacts with water, producing carbonic acid (H<sub>2</sub>CO<sub>3</sub>), and pH is lowered.



Carbon dioxide rarely causes direct toxicity to fish. However, high concentrations of lower pond pH can limit the capacity of fish blood to carry oxygen by lowering blood pH at the gills.

**Figure 164.** Relative concentration changes for dissolved oxygen, carbon dioxide and pH in ponds over 24 hours

		Change	
Time	Dissolved Oxygen	Carbon Dioxide	pH
Daylight	Increases	Decreases	Increases
Nighttime	Decreases	Increases	Decreases

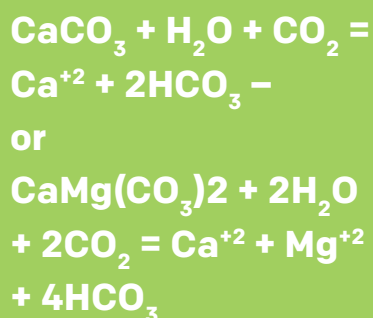
At a given dissolved oxygen concentration (e.g., 2 mg/L, milligrams per liter), fish may suffocate when CO<sub>2</sub> levels are high and appear unaffected when CO<sub>2</sub> is low. Many fish can tolerate 20 to 30 mg/L CO<sub>2</sub> if accumulation is slow and dissolved oxygen concentrations are above 5 mg/L. In a reservoir or natural pond, CO<sub>2</sub> rarely exceeds 5 to 10 mg/L but in intensively fed aquaculture ponds, elevated CO<sub>2</sub> levels are not uncommon. High CO<sub>2</sub> concentrations are almost always accompanied by low dissolved oxygen concentrations (high respiration). Aeration used to increase low DO (dissolved oxygen) will also help reduce excess CO<sub>2</sub> by improving its diffusion back into the atmosphere. Chronically high CO<sub>2</sub> levels can be treated chemically with hydrated lime, Ca(OH)<sub>2</sub>. Approximately 1 mg/L of hydrated lime will remove 1 mg/L of CO<sub>2</sub>. This treatment should not be used in waters with low alkalinity (poor buffering capacity) because pH can rise quickly to levels lethal to fish. Also, fish could be endangered if hydrated lime is added to waters with high ammonia concentrations. High pH increases the toxicity of ammonia.

#### Alkalinity

Total alkalinity is the measure of common bases found in fishpond water that include carbonates, bicarbonates, hydroxides and phosphates. Carbonates and bicarbonates are the most common and important components of fishpond alkalinity.

Alkalinity, the buffering capacity of water, is measured by the amount of acid (hydrogen ion) water can absorb before achieving a designated pH. Total alkalinity is expressed as milligrams per liter calcium carbonate (mg/L or CaCO<sub>3</sub>). A total alkalinity greater than 20 mg/L is necessary for generally good pond productivity. A more desirable range of total alkalinity for commercial fish culture ponds is between 75 to 250 mg/L CaCO<sub>3</sub>. Carbonate-bicarbonate alkalinity (and hardness) in surface, well or borehole waters is produced primarily through the interactions of CO<sub>2</sub>, water and limestone. Rainwater is naturally acidic because of its exposure to atmospheric carbon dioxide. As rain falls to the earth, each droplet becomes saturated with CO<sub>2</sub>; and its pH is lowered. Well water is pumped from large, natural underground reservoirs (aquifers) or small, localized pockets of underground water (groundwater). Typically, underground water contains high CO<sub>2</sub> concentrations, low pH and oxygen concentrations. Carbon dioxide is high in underground water because of bacterial processes in the soils and various underground, particulate mineral formations through which water moves.

As ground or rainwaters flow over and percolate through soil and underground rock formations containing calcitic limestone ( $\text{CaCO}_3$ ) or dolomitic limestone [ $\text{CaMg}(\text{CO}_3)_2$ ], the acidity produced by  $\text{CO}_2$  will dissolve limestone and form calcium and magnesium bicarbonate salts:



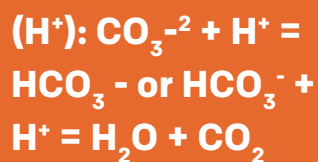
The resultant water has increased alkalinity, pH and hardness. Alkalinity, pH and carbon dioxide concentrations in water with moderate to high alkalinity (good buffering capacity), similar hardness levels, pH being neutral or slightly basic (7.0 to 8.3) will not fluctuate widely. Higher amounts of  $\text{CO}_2$  (i.e., carbonic acid produced by photosynthesis) or other acids are required to lower pH because there is more base available to neutralize or buffer the acids.

### Linkages between Alkalinity, pH and Photosynthesis

The bases associated with alkalinity react with and neutralize acids. Carbonates and bicarbonates can react with both acids and bases and buffer (minimize) pH changes in pond water. The pH of well buffered water normally fluctuates between 6.5 to 9.0. In waters with low alkalinity, pH can reach dangerously low levels ( $\text{CO}_2$  and carbonic acid from high respiration) or dangerously high levels (rapid photosynthesis) (Figure 165).

Phytoplankton is responsible for most of the oxygen (photosynthesis) and primary productivity in ponds. By stabilizing pH at or above 6.5, alkalinity improves phytoplankton productivity (and pond chemistry stability) by increasing nutrient availability (soluble phosphate concentrations). Alkalinities at or above 20 mg/L trap  $\text{CO}_2$  and increase the concentrations available for photosynthesis. Because phytoplankton use acidic  $\text{CO}_2$  in photosynthesis, the pH of pond water increases (becomes more alkaline) as carbonic acid (i.e.,  $\text{CO}_2$ ) is removed.

### High pH could also be viewed as a decrease in hydrogen ions



The release of carbonate converted from bicarbonate by plant life can cause pH to climb dramatically (pH > 9.0) during periods of rapid photosynthesis from dense unmixed phytoplankton blooms.

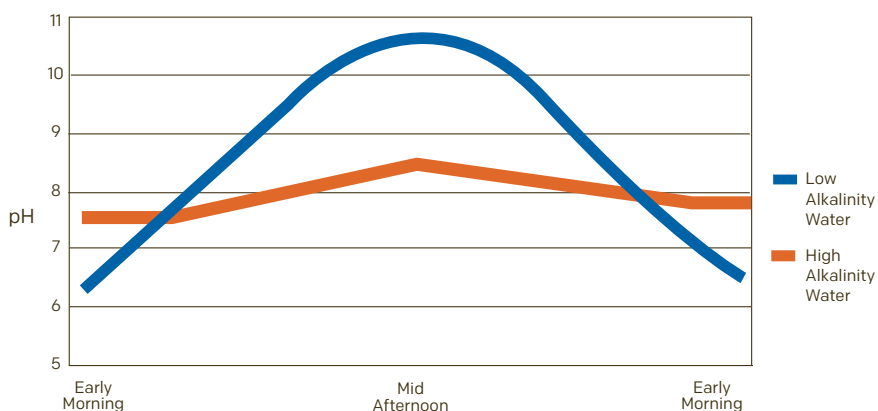
This rapid rise in pH can occur in low alkalinity water (20 to 50 mg/L) and also in water with moderate to high bicarbonate alkalinity (75 to 200 mg/L) that has less than 25 mg/L hardness. High bicarbonate alkalinity in soft water is produced by sodium and potassium carbonates which are more soluble than the calcium and magnesium carbonates that cause hardness. If calcium, magnesium and photosynthetically produced carbonate are present when pH is greater than 8.3, a limestone precipitate is formed.

### Hardness

Water hardness is important in fish culture ponds and is a commonly reported aspect of water quality. It is a measure of the quantity of ions such as calcium, magnesium and/or iron in water. Hardness can be a mixture of dissolved salts, however, calcium and magnesium salts are the most common sources of water hardness.

Hardness is traditionally measured by chemical titration. The hardness of a water sample is reported in milligrams per liter as calcium carbonate (mg/L  $\text{CaCO}_3$ ).

**Figure 165.** Changes in pH during a 24-hour period in waters of high and low total alkalinities



Calcium carbonate hardness is a general term that indicates the total quantity of divalent salts present and does not specifically identify whether calcium, magnesium and/or some other salt is the source of water hardness. Hardness is commonly confused with alkalinity (the total concentration of base). The confusion relates to the term used to report both measures, mg/L CaCO<sub>3</sub>. If limestone is responsible for both hardness and alkalinity, the concentrations will be similar if not identical. However, where sodium bicarbonate (NaHCO<sub>3</sub>) is responsible for alkalinity it is possible to have low hardness and high alkalinity. Acidic ground or well water can have low or high hardness and have little or no alkalinity.

Calcium and magnesium are essential in the biological processes of fish (bone and scale formation, blood clotting and other metabolic reactions). Fish can absorb calcium and magnesium directly from the water or from food. However, calcium is the most important environmental, divalent salt in fish culture water. The presence of free (ionic) calcium in aquaculture water helps reduce the loss of other salts (e.g., sodium and potassium) from fish body fluids (i.e., blood) when they suffer chronic or acute stressors. Sodium and potassium are the most important salts in fish blood and are critical for normal heart, nerve and muscle function. Research has shown that environmental calcium is also required to re-absorb these lost salts. In low calcium water, fish can lose (leak) substantial quantities of sodium and potassium into the water. Body energy is used to reabsorb the lost salts.

For some species which originate in brackish or marine waters (e.g., red drum and striped bass), relatively high concentrations of calcium hardness are required for survival and viability as commercial species.

A recommended range for free calcium in culture waters is 25 to 100 mg/L, expressed as 63 to 250 mg/L CaCO<sub>3</sub> hardness. Many fish can tolerate low calcium concentrations if their feed is complete and balanced and contains a minimum level of mineral calcium. But they will likely grow slowly under these conditions unless water chemistry is amended.

Agricultural limestone can be used to increase calcium concentrations (and carbonate-bicarbonate alkalinity) in areas with acid waters or soils. However, at a pH of 8.3 or greater, agricultural limestone will not dissolve. Agricultural gypsum (calcium sulfate) or calcium chloride could be used to raise calcium levels in soft, but alkaline waters. The expense of calcium chloride might be prohibitive if large volumes of water need treatment. Identifying a suitable water source may be more practical.


Ideally, an aquaculture pond should have a pH between 6.5 and 9.0 as well as moderate to high total alkalinity (75 to 200, but not less than 20 mg/L) and a calcium hardness of 100 to 250 mg/L CaCO<sub>3</sub>. A fundamental understanding of the concepts and chemistry underlying the interactions of pH, CO<sub>2</sub>, alkalinity and hardness is necessary for effective and profitable aquaculture pond management.

## Ammonia

Ammonia is toxic to fish if allowed to accumulate in fish production systems. When ammonia accumulates to toxic levels, fish cannot extract energy from feed efficiently. If the ammonia concentration gets high enough, the fish will become lethargic and eventually die. In properly managed IPRS fishponds, ammonia seldom accumulates to lethal concentrations. However, ammonia and its breakdown product (nitrite) can have “sublethal” effects—such as reduced growth, poor feed conversion and reduced disease resistance—at concentrations that are lower than lethal concentrations.

## Effects of pH and temperature on ammonia toxicity

Ammonia in water is either unionized ammonia (NH<sub>3</sub>) or the ammonium ion (NH<sub>4</sub><sup>+</sup>) form. The techniques used to measure ammonia provide a value that is the sum of both forms. The value is reported as “total ammonia” or simply “ammonia.” The relative proportion of the two forms present in water is mainly affected by pH. Un-ionized ammonia is the toxic form and predominates when pH is high. The ammonium ion is relatively nontoxic and predominates when pH is low. In general, less than 10% of ammonia is in the toxic form when pH is less than 8.0. However, this proportion increases dramatically as pH increases.



In ponds, pH fluctuates with increasing photosynthesis (which increases pH) and increasing respiration (which reduces pH) of pond organisms. Therefore, the toxic form of ammonia ( $\text{NH}_3$ ) predominates during the late afternoon and early evening and ammonium ( $\text{NH}_4^+$ ) predominates from before sunrise through early morning. The equilibrium between  $\text{NH}_3$  and  $\text{NH}_4^+$  is also affected by temperature. At any given pH, more toxic ammonia is present in warmer water than in cooler water.

### Ammonia dynamics in fish ponds

The measurement of ammonia concentration (and that of many other water quality variables) provides only a snapshot of conditions at the time a water sample is collected. A single measurement provides no insight into the processes that affect ammonia concentrations; it is simply the net result of processes that produce ammonia and processes that remove or transform ammonia. The relationships among these processes are complex, but the important point is that the rates change differentially throughout the year and result in the measured patterns we see.

### Ammonia sources

The main source of ammonia in all fishponds is fish excretion. The rate at which fish excrete ammonia is directly related to the feeding rate and the protein level in feed. As dietary protein is broken down

in the body, some of the nitrogen is used to form protein (including muscle), some is used for energy and some is excreted through the gills as ammonia. Thus, protein in feed is the ultimate source of most ammonia in ponds where fish are fed. Another main source of ammonia in fish ponds can be diffusion from the bottom sediment. Large quantities of organic matter are produced by plankton or added to ponds as feed. Fecal solids excreted by fish and dead algae settle to the pond bottom where they decompose. The decomposition of this organic matter produces ammonia, which diffuses from the sediment into the water column. In IPRS ponds operated according to our principles, water mixing, aeration and flow reduce the deposition of fecal material and other organic matter onto the pond bottom. Rather, much of the waste load as settled solids is removed from the IPRS pond Quiescent Zone (QZ) or organic particles are processed at an accelerated rate by continually mixing and moving the water column.

### Ammonia sinks

There are two main processes that result in the reduction or transformation of ammonia in the water column. The most important is the uptake of ammonia by plankton and bacteria. Photosynthesis acts like a sponge for

ammonia, so factors that increase overall plankton growth typically will increase ammonia uptake. Such factors include sufficient light, warm temperature, abundant nutrient supply and to a point, plankton density. The other important process of ammonia transformation in fishponds is "nitrification." Bacteria oxidize ammonia in a two-step process, first to nitrite ( $\text{NO}_2^-$ ) and then to nitrate ( $\text{NO}_3^-$ ). The main factors that affect nitrification rate are ammonia concentration, temperature and dissolved oxygen concentration. During warm temperatures, ammonia concentrations are generally very low and so nitrification rates by bacteria are also very low. Using IPRS principles, continual water mixing and flow develop a more robust bacterial community when we provide higher DO levels during warm weather. In climates where winter temperatures occur, low temperatures can suppress nitrifying microbial activity. In temperate climates during spring and fall when ammonia concentration and temperature are intermediate in traditionally managed ponds, conditions favor maximum nitrification rates. But, it is common to see buildups of nitrite ( $\text{NO}_2^-$ ) in spring or fall because the nitrifier community (specifically *Nitrobacter* populations) is not healthy or has collapsed due to a variety of environmental factors, such as windy cold weather or heavy rainfall.

### When is ammonia most likely to be a problem?

In modern fishponds, it is unlikely that unionized ammonia would accumulate to a concentration that would become toxic enough to kill fish. However, unionized ammonia will occasionally accumulate to levels that cause sublethal stress effects such as mortality due to disease.



- During winter in temperate climates:** It is generally assumed that ammonia is not a problem in the winter because feeding rates are very low. Fish are fed on only the warmest days of winter, usually when the water temperature is higher than 50F. However, ammonia concentration tends to be greater during winter (2.5 to 4.0 mg/L, or even higher) than during summer (less than 0.5 mg/L). The relatively low concentration during summer can be attributed to intense photosynthesis by plankton, which removes ammonia. Winter temperatures reduce the uptake of ammonia by plankton. But in traditional ponds, the ammonia supply continues, primarily from the decomposition of organic matter that accumulated on pond sediment during the growing season. IPRS ponds typically record reduced ammonia and byproduct concentrations because a greater level of nitrification and assimilation has already taken place due to management using IPRS principles.
- After the die-off of a plankton bloom:** Often traditionally managed ponds develop very dense algae blooms dominated by one or two species. For reasons that are not well understood, these blooms are subject to spectacular collapse, often called a “die-off,” where most of the plankton suddenly die. When this occurs, ammonia concentration increases rapidly because the immediate mechanism for ammonia removal— plankton uptake—has largely been eliminated.

Rapid decomposition of dead algae reduces the dissolved oxygen concentration and pH and increases ammonia and carbon dioxide concentrations. After the die-off of a plankton bloom, ammonia concentration can increase to 6 to 8 mg/L and pH can decline to 7.8 to 8.0.

Principles of continual water mixing, aeration and movement dramatically reduce the possibility of 1 to 2 plankton species domination in IPRS ponds. Speciation is more diverse and less prone to major die-offs of particular species as a result of numerous factors known to trigger such die-offs (weather, seasonal change, etc.) This does not mean to imply that IPRS ponds don’t experience plankton die-offs. In IPRS managed ponds, the effects are much reduced in the impact on the pond.

#### Ammonia management options

- Stopping feeding or reducing the feeding rate, will it help?:**

The primary source of nearly all the ammonia in fishponds is the protein in feed. When feed protein is completely broken down (metabolized), ammonia is produced within the fish and excreted through the gills into pond water. Therefore, it seems reasonable to conclude that ammonia levels in ponds can be controlled by manipulating feeding rate or even feed protein level. While this may be true to some extent, it depends on whether you want to control it over the short-run (days) or the

long-run (weeks or months). In the short-run, sharp reductions in feeding rate have little immediate effect on ammonia concentration. In essence, trying to reduce ammonia levels by withholding feed can be compared with trying to stop a fully loaded freight train running at top speed—it can be done but it takes a long time. Producers can reduce the risk over the long-run by using only high quality nutritionally complete and balanced feeds and following all of IPRS principles.

There are several other remedies thought to be helpful in managing higher levels of ammonia. Most do not actually work; some are impractical, expensive and in the end do little to impact ammonia concentrations in the short run. Fish producers should not be alarmed if ammonia concentration becomes elevated, although a high ammonia level often indicates that nitrite concentrations may soon rise. In this case, farmers should focus on protecting fish from nitrite poisoning by adding salt, rather than on trying to manage the ammonia problem. Extra vigilance after a bloom die-off is also warranted. Usually, the concentration of ammonia will fall again once the bloom becomes re-established. Because there is little that can be done to correct problems with ammonia once they occur, the key to ammonia management is to use fish culture practices that minimize the likelihood of such problems.



Carbon dioxide concentrations are highest when dissolved oxygen concentrations are lowest. Thus, dawn is a critical time for evaluating pond water quality from the standpoint of both dissolved oxygen and, to a lesser extent, carbon dioxide. Fish can rid themselves of carbon dioxide through the gills in response to a difference in carbon dioxide concentration between fish blood and the surrounding water. If environmental carbon dioxide concentrations are high, the fish have difficulty reducing internal carbon dioxide concentrations, resulting in accumulation in fish blood. This accumulation inhibits the ability of hemoglobin, the oxygen carrying molecule in fish blood, to bind oxygen, and may cause the fish to feel stress similar to suffocation. The density of the algae bloom has an important effect on the magnitude of daily fluctuations of oxygen and carbon dioxide. Oxygen and carbon dioxide concentrations in ponds with a light algae bloom will not fluctuate very much between early morning and late afternoon, analogous to “shallow breathing.” In ponds with a dense bloom, fluctuations are more extreme, analogous to “deep breathing.” Carbon dioxide problems are more likely as the density of the bloom increases.

Summer is the time of year when carbon dioxide is most likely to be a problem in fishponds. Warm water temperatures increase the metabolic rate of all pond organisms and therefore respiration rates are high. It is also the time of year when feeding rates are high.

The decomposition of wastes generated by large quantities of organic matter added to fishponds in the summer requires large quantities of dissolved oxygen and produces large quantities of carbon dioxide. The IPRS principle of continual water mixing, aeration and solid waste removal better manages the sources and sinks of dissolved oxygen. In addition to supplying critical dissolved oxygen, aeration and mixing will drive off some portion of the carbon dioxide produced in the pond as well as reduce the BOD and COD.

- **Carbon dioxide is a somewhat unusual problem in fish ponds:** In general terms, elevated carbon dioxide concentration is rarely a cause for concern in fishponds with sufficient alkalinity. There are a few specific circumstances or scenarios in which carbon dioxide may be a problem, such as the period following the die-off of a plankton bloom or the application of an algaecide, such as copper sulfate. Large quantities of organic material derived from dead plankton are quickly decomposed, reducing oxygen and increasing carbon dioxide concentrations. Again, emergency aeration practices serve the dual role of supplying oxygen and reducing carbon dioxide.

In IPRS ponds, continual mixing, aeration and movement of water through the raceways and around the pond actions reduce these incidences, but they still may occur. Healthy pond biota resulting from fully practicing IPRS principles is most beneficial in managing productive pond ecosystems.

- **Chemical treatment is a temporary solution:** Carbon dioxide can be removed by chemical treatment of pond water with liming agents such as quicklime, hydrated lime, or sodium carbonate. These liming agents chemically react directly with carbon dioxide, resulting in reduced carbon dioxide and increased alkalinity and pH. The effects of treatment to remove carbon dioxide can provide immediate relief to aquaculture ponds but these are temporary. Agricultural lime will not chemically remove carbon dioxide from pond waters. To calculate the amount of a particular liming agent to apply to a pond, the following generalized formula can be used. The formula below estimates the treatment requirements for a given pond size.

#### Specific liming agent and chemical factor

- **Quicklime (CaO)**  
**Chemical factor: 3.45**
  - Caustic (protect skin and eyes)
  - Potential for high pH
  - Relatively low solubility
- **Hydrated lime (Ca(OH)<sub>2</sub>)**  
**Chemical factor: 4.57**
  - Caustic (protect skin and eyes)
  - Potential for high pH
  - Relatively low solubility
- **Sodium carbonate (Na<sub>2</sub>CO<sub>3</sub>)**  
**Chemical factor: 6.48**
  - Safe
  - Low potential for high pH
  - Relatively high solubility
  - Quick reaction with carbon dioxide

Application of chemicals to treat a carbon dioxide “problem” is likely to be of limited, temporary benefit.

Aeration and mixing as we prescribe as IPRS principles are the most effective available methods for the management of carbon dioxide and dissolved oxygen. Continual aeration with vertical mixing practices we use with IPRS accelerates the diffusion of carbon dioxide out of water and mixing will help prevent and minimize the establishment of carbon dioxide-rich portions of the water column.

Wurts, W.A. and R.M. Durborow. December 1992, [Southern Regional Aquaculture Center, Publication # 464](#)

Durborow, R.M., D.M. Crosby, and M. W. Brunson. June 1997, [Southern Regional Aquaculture Center, Publication # 462](#)

## APPENDIX B: Experiences with IPRS: Some Lessons Learned the Hard Way

Farmers, operators and early adopters of IPRS all over the world are typically moved to quickly adopt a new idea or technology. In their haste and enthusiasm, they may miss key elements that must be applied to avoid expensive lessons. Some of those lessons appear here to allow the reader to learn from past mistakes. Applying all the IPRS principles discussed in this manual will help avoid costly mistakes.

### Safety Around IPRS

All agricultural technologies carry with them risks to personnel and property. Mentioned below are some concerns. Maintaining a safety oriented IPRS workplace is a matter of choice. Farming is one of the most dangerous occupations, so it is important to make the choice to apply these safety practices on IPRS facilities.

Electricity is a powerful tool, and it can kill if misapplied. Be sure your electrical cables, connections, switches and associated gear are installed according to governing electrical codes and protected from wear, weather and physical damage that may lead to an electrical injury or death.

Any time someone is working on your electrical gear or equipment, it is critical to be sure electrical power is switched off and with appropriate lockouts until the work is completed and all workers are clear of wiring and equipment before operation is resumed by switching on the system and restoring electrical power.

Electricity is invisible and can go places in a wet or damp environment you might not expect. Be careful.

Almost all farms including fish farms have equipment with moving components driven by electrical or fuel powered motors and engines. These are killers on many farms every year. They may catch your clothing, shoestring or even your hair and cause you to be killed or severely injured very quickly. Exercise special attention and care when working around such equipment.

IPRS facilities are especially dangerous for children. With the sound of blowers and equipment operating, fish feeding and splashing as well as many activities on the facility, it is almost impossible to hear a child fall into the water. The water is deep and raceway sides slippery, and it has a significant flow making it dangerous for children or any who are not swimmers. Avoid a tragedy, do not allow children on IPRS facilities.

### Designing and Construction Lessons Learned:

- Too many raceways for the size / volume pond leads to improper PZ volume to pond volume ratio
- Lack of vertical columns for wall support
- Columns incorrectly designed and wider than walls
- Knee walls in the wrong place
- Improperly constructed gate slots or only one instead of two
- Improper supplementary aeration installation and extending too far down raceway
- Gate material is not robust enough or made of netting
- Mistakes with the solids collection and removal system
- WWU construction mistakes
- Improperly constructed baffle or improper materials



**Installation and Commissioning Lessons Learned:**

- Starting system too soon without testing equipment
- Improper WWU operation, insufficient air volume, small horsepower, wrong diffuser tubing
- Starting without a proper bloom
- Improperly installed or none or generator too small for the load

**Management Lessons Learned:**

- Feeding improper USSEC recommended diets
- Feeding sinking feed
- Overfeeding and wasting feed
- Grading and partial harvesting
- Improper sampling that disrupts fish growth and causes mortalities
- Waste removal system abandoned or not operated frequently enough
- Use of paddlewheels in open pond instead of WWUs
- Improper handling of fingerlings and stocking without prophylactic treatments
- Neglecting to clean confinement gates and diffuser grid tubing



**For more information about IPRS, contact [IPRS@ussec.org](mailto:IPRS@ussec.org).**

# APPENDIX C:

## Glossary of terms

Term	Meaning
<b>90% satiation</b>	Feeding method where fish determine ration, and no calculations are required
<b>%BWD</b>	Percent of biomass (body weight) daily is a calculated feeding method
<b>Baffle wall</b>	Structure which directs water around the full IPRS pond
<b>Cell</b>	Another term for raceway Production Zone
<b>DO</b>	Dissolved Oxygen
<b>EBG</b>	Enterprise Budget Generator (economics spreadsheet)
<b>FCR</b>	Feed Conversion Ratio, expressed as feed fed/weight gained
<b>Fed species</b>	Fish which are held and fed in the raceway cell production zone (PZ)
<b>IPRS</b>	In-Pond Raceway System
<b>Mixing</b>	Eliminating stratified layers of water with WhiteWater Unit, DO management
<b>Open pond</b>	Pond area and volume outside raceway cells
<b>PZ</b>	Production Zone: part of the raceway where fish are held and fed
<b>QZ</b>	Quiescent Zone: End part of raceway where solid wastes settle and are removed
<b>Raceway</b>	Rectangular linear structure where fish are confined and fed
<b>Service sp.</b>	Unfed species in open pond
<b>Stratification</b>	Layers of pond water with top-to-bottom reduction of DO and temperature
<b>Unfed species</b>	Filtering or service species in the open pond; filter and graze pond biota
<b>USSEC</b>	United States Soybean Export Council
<b>Water flow</b>	“River in a pond” concept of water circulation within a pond
<b>WWU</b>	WhiteWater Unit: Water mixing, aeration, and flow development device

## APPENDIX D: Frequently Asked Questions (FAQs)

### How many raceways are correct for my pond(s)?

The number of raceways you install is based on the volume of your pond. For each 10,000 m<sup>3</sup> of pond volume, you should install one raceway. Therefore, for a pond holding a volume of 30,000 m<sup>3</sup> of water; you would install 3 standard commercial raceways using 220 m<sup>3</sup> production zones.

### Can I buy the IPRS gear?

Yes. Depending upon where you are located, there are companies who can supply your equipment needs. We strongly encourage you to connect with the USSEC technical staff in your region or country to secure the most up to date information regarding equipment. IPRS is a new technology which requires and uses specific types of equipment with specific performance characteristics. If alternative gear or materials are used, we have most often found poor performance results and potential accompanying financial loss. We want you to be successful, so, follow the direction of your local USSEC support person.

### What is the cost for IPRS?

The cost to plan, install and operate IPRS is variable depending upon your location. Section 7 in this manual describes the capital cost for design, build and operation of IPRS in several locations. The spreadsheet tools provided give you examples of cost items to give you direction in filling in on the spreadsheet accurate information on costs in your local environment. Doing this, you can construct an accurate financial snapshot of cost to build and operate IPRS in your locale.

### I have been fish farming for many years, I have many paddlewheels. Can I use them instead of WWUs or other devices?

No. Paddlewheel aeration devices have their place in aquaculture. However, we have not found them to be cost effective to operate within the IPRS principle we teach you. Paddlewheels are most useful in shallow (1 meter) traditional ponds. Because they aerate and agitate only the upper 8 to 10 cm and impact the top 1 meter of the water column, they are not recommended for use in IPRS ponds which are 2 to 3-meters deep. WhiteWater Units (WWU) function to mix, aerate and circulate the full pond depth at low operational cost and very low maintenance costs.

### Can I adopt IPRS without locally supplied electricity?

IPRS is an advanced form of pond aquaculture which has specific requirements for making a financially sound, viable and sustainable investment. Reliable electrical service offered at a reasonable cost is absolutely required. In rural areas where one might develop and operate traditional earthen ponds, especially where very modest inputs justify very modest outputs, are not generally able to adopt advanced technologies until local infrastructure can support the building and operational costs required by IPRS technology. While electrical energy derived from solar panels is technically possible, we are not aware of sites using solar energy systems in commercial application of IPRS.

### Where can I get technical support for IPRS?

Technical assistance is available from in-country or regional USSEC staff persons, see Appendix G in this manual to find the person and their contact information for your area. It is very important to contact these professionals as they are available to assist you in understanding IPRS technology and to avoid making missteps if you decide to adopt this modern approach to aquaculture.

### What feeds can I use? I typically use sinking feed; can I use it in IPRS?

Only extruded, floating feeds are recommended for use in IPRS. High quality floating rations are designed for high performance in growth, weight gain and stock survival. Animals cultured in confinement typically perform best if both their environment and the feed nutrients they take in are as close to optimal as possible. Using IPRS, fish are held in a very high-quality raceway environment where high quality floating diets are able to demonstrate feed nutrient retention not typical in traditional pond culture. Further, by predictably seeing feed conversion rates ranging from 1.0- to 1-3:1.0, the volume of waste produced by feeding the fish is most often reduced by nearly 50%. IPRS operated using principles we teach allow growers to at least double and often triple the annual yields seen in traditionally managed ponds that use sinking feeds.

### **Are there any enterprise budgets or spreadsheet tools I can use to look at the business before making any investment?**

Yes. Section 7 provides spreadsheets and economic analysis tools you can use to develop the financial information you can use in making business decisions to adopt IPRS for your operation or how you might use/grow different species to hedge your investment regarding market price volatility. Follow up with your IPRS technical support person for assistance.

### **I only have small ponds. How can I reconfigure them for IPRS?**

Combining several small ponds into a single larger pond is a good choice when adopting IPRS technology for your farm. Depending upon your location and soils, you have options. Try to use the existing perimeter levee if possible. Simply reconfigure cross levees by moving soil against the perimeter levee face or use their soil in developing your baffle wall. You can also “turn” them where they are in parallel with planned water flow. That is, they are simply “islands within the river flow”.

- It is very important when you are reconfiguring pond systems that planned pond volume objectives are reached.
- Soils used to reconfigure the pond are carefully compacted for stability and avoidance of erosion to maintain pond volume and function.

### **With the density of fish recommended in IPRS, is fish health a big issue?**

Fish health and survivorship in IPRS is a primary focus. The fish are in contact more with each other than in traditional pond culture, but it is easier to observe them and their behavior to apply any prophylaxis or treatment at a cost far below full pond treatment costs. We typically see less issues with disease or parasite infestation due to the high-quality water and raceway cell environment. See Section 4.15 for detailed fish health management actions. Using high quality diets along with the excellent environment provided by IPRS can help avoid many fish health issues.

### **How often do I need to drain my pond when using IPRS?**

When you are operating an IPRS facility, draining ponds for harvest is no longer practiced. Rather, we want to value and the water and the biota we have developed in it. The only time we do drain the IPRS pond is to make repairs to the system which cannot be done with a full pond. We do replace water lost through evaporation and seepage, but there is no need to discharge into local water bodies or waterways. IPRS ponds are not drained for harvest or need winter drawdown unless there is an overriding need for a system repair.

### **Would it be a better design to develop a different shape for the QZ? Would a deeper floor or even a “V” bottom be better?**

No. We tried that approach many years ago with poor results. We found the settled solids do not flow particularly well so slopes on the sides of a “V” shaped bottom need to be steep (60 to 65 degrees).

Further, we found that a broader flat bottom to the QZ offered a better surface for regular use of automatic gear (programmed).

### **Can I still exchange water from the IPRS pond with local canal?**

No. We do not recommend bringing in or discharging any new water other than for replacement of water lost to seepage or evaporation. We highly value the water we retain in the pond as we build a highly effective set of assimilation organisms we use and protect.

### **What pond water quality supplements are recommended for IPRS?**

Typically, no water quality supplements are used or recommended. Only agricultural limestone is used as an amendment to soil or water chemistry. Pond water alkalinity levels should be greater than 100 mg/l. If you have detected elevated levels of ammonia ( $\text{NH}_4^-$ ) in your pond(s), this is not particularly unusual or alarming. Typically, it is a response to a die-off of plankton which have been absorbing the ammonia. Your best short-term option is to reduce feeding to 70% to 75% of normal ration for 4 to 5 days while you continue normal IPRS operations. You should be on the lookout for elevated nitrite ( $\text{NO}_2$ ) following an ammonia spike and be sure your pond chloride level is 100 to 150 mg/l. This is an occasion where rock salt is added to IPRS or traditional ponds when sodium (Na) levels are low (<100 mg/l) to protect fish from stress or mortality from nitrite poisoning. Nitrite concentrations can become elevated after plankton bloom die-offs or if the bacterial community which breaks down nitrite, as a part of the nitrogen cycle in the pond, is compromised for some reason.

### **Can I feed fish I stock in the open water the service species?**

No. One of our main principles for IPRS is there is no feeding of any stock outside of the raceway cells themselves. The service species in the open water are stocked at densities where their filtering and foraging actions are beneficial to the full pond environment as they fix unused nutrients in marketable form.

### **If I build a three-raceway system as you recommend, what do you suggest as start-up procedures?**

We recommend an operational period of about a month duration to make the necessary checks and adjustments to IPRS gear as well as to develop the biota necessary for rapid nutrient assimilation. See Section 3 for a detailed run down for start-up.

### **I have fish ponds and lotus paddies. Can I incorporate some lotus production within the IPRS pond?**

No. Leave the lotus production where it is in a separate water body or paddy. Lotus incorporated into IPRS ponds disrupt many of the important processes that IPRS need to operate efficiently and reliably. Shade provided by lotus leaves limits the development of phytoplankton to the densities needed for top IPRS performance. Further, water flow, movement through lotus stems or paddies is slow due to the lotus plant stems and biomass.

Producers who adopt IPRS should not employ any rooted or floating plants in the system ponds.

That said, the waste stream (liquid and settled solids) can be pumped from the IPRS pond and fully utilized as fertilizer for lotus. This set of nutrients, unused by the fish, can be highly beneficial to lotus, rice, coconuts, oil palms, fruit orchards, applied on grain fields and so forth.

### **Can I grow river crab in IPRS ponds?**

River crabs perform well in freshwater systems, and thus, may do well in IPRS ponds. However, if a producer decides to use river crab in IPRS ponds, they must be stocked in open water and allowed to forage- they are not fed. For this reason, most don't stock river crab in IPRS because the crab needs to be fed for a reasonable growth rate to be achieved. Unless some other approach is determined, we don't recommend stocking river crab.

### **Is it safe to use all the electrical equipment I see for IPRS?**

Operating electrical gear anywhere comes with some level of danger. However, if electrical installations are made correctly by skilled personnel, the risk for electrical accidents is minimal. Most modern aquaculture facilities use more electricity year on year. Electricity typically offers opportunities for equipment use far less expensively than diesel, gasoline or LP fired equipment does. See Sections 2.16 and 5.7 for more details about electrical installations and safety.

### **Can I build IPRS with much cheaper materials (plastic, wood, sheet metal)?**

You can, but the more important question is is it a wise financial move, given the size of the investment needed for IPRS? We do not believe it is a prudent move because the IPRS technology has been developed over 30 years evaluating many types of ideas, equipment and materials.

Over the course of this development, IPRS researchers have tried numerous materials and equipment and have consolidated these findings into the information put forth in this manual. For the most desirable, predictable, financially and biologically sustainable outcomes use the materials and gear described in this document. Deviation from this information and operational process will typically lead to poor performance and financial loss.

### **My WhiteWater Unit when I installed it seemed to work well, now not so well — what is the cause?**

A couple of things might be curbing air flow from your WWU. First, is your blower operating correctly? Have you serviced the blower air filter canister recently (in the last week or two)? Second, your diffuser tubes under the WWU may be clogged with pond organisms or biofilms which cling tightly to the diffuser material and can greatly reduce air flow from the WWU. Best solution is to do a full maintenance event on the units not performing up to standards. We recommend taking a short video when you are first operating the WWUs so you have a comparison to WWU operation over time.

### **Are all diffusers alike? Why should I buy the Colorite diffuser tubing?**

No. Diffusers are as different as any tool or equipment both as to their designed function as well as their efficiency in doing their intended job. Colorite tubing (also known as Aero-Tube) is designed for diffusion of air into shallow water. It is not designed to deliver pure oxygen or high-pressure air into deeper water. Aero-Tube is a highly efficient diffuser which is relatively inexpensive and offers excellent utility and function when used in IPRS.



Our aim in selecting Aero-Tube was that it struck the best balance between aeration efficiency and water velocity developed within the WWUs for movement of water through the raceway cells and around the pond. Many other diffusers are available from those marketing diffusers in aquaculture equipment marketplaces. Many are diffusers designed for other uses, but some are copies of Aero-Tube and offer poor performance, thereby are a poor investment decision. Until other suppliers of diffusers offer actual performance data from a third-party, which are similar in function to Aero-Tube, those products will not be recommended. We encourage innovation, though in this instance producers make better financial choices to use gear with known performance parameters we describe here.

Sometimes, we have operators point out their air flow seems to have declined or is not uniform in flow output across the WWU. This is a classic sign that the diffuser tubing is clogged typically with some bio-film or other fouling biota growing on the tubing. The solution is usually to perform maintenance cleaning on the WWU diffuser racks and tubing.

### **Can I culture marine fish in IPRS?**

This manual is specific to freshwater systems. USSEC has some experience and developed some data in marine systems but we are not recommending them for IPRS at this time. We recommend you contact your USSEC representative for more information on page 72.

### **How do I manage for good fish health and high survival?**

High survivorship of your stock is the number one element, leading to an attractive ROI. You should clearly remember three points: You want to be sure to start with stock that is uniform size and free of disease. Your supplier should be willing to work with you regarding supplying you with fingerlings which have been well fed and treated with registered materials to remove external parasites or bacteria. To stock your cells, a significant number of fish will be required so your supplier should be willing to meet these needs for you to be successful. Further, after you receive and stock these animals, you should use a reasonable level of parasite and disease prophylaxis to maintain them in a clean, healthy condition.

More important than veterinary care and treatment, is the offering of high-quality feed in amounts where your stock can thrive, grow and maintain their natural levels of resistance to pests, parasites and bacterial disease organisms.

Maintaining a high-quality environment for your stock is critical.

IPRS, operated according to our principles, will allow you to provide your animals a high-quality living space. Operating and maintaining IPRS gear according to the USSEC principles will put you in the best position to provide an excellent quality environment for your fish.

### **What do I do if my fish get sick in IPRS cells?**

We always hope our fish will not get sick, but it can happen. (See Section 4.15 to 4.16). Always strive to prevent your fish from becoming stressed, which often leads to some getting sick or even dying, predominantly from a stressor. If you have sick fish in your IPRS, first you need to determine what is making them sick. Typically, they will be responding to environmental stressors, parasites on skin or gills or a bacterial infection (internal or external). First, don't wait — determine the likely cause. Second, have a plan. Fish do get sick occasionally so, have a means of getting veterinary help quickly if you cannot determine the cause yourself. Third, experienced managers typically keep therapeutic materials on the farm. This is especially easy and inexpensive with IPRS because the amount of material needed for treatments is small compared to treating a full pond. Apply the correct treatment on the fish and be prepared to make follow-up applications.

The more quickly you recognize and identify the problem, the more quickly you can correctly respond to a disease.

Generally, your standard fish health treatment materials will solve health issues if your actions are correct and swift.

### **Will my fish all die if electricity is interrupted?**

The IPRS is robust and generally predictable. However, electric power interruptions are not predictable. For this reason, the principles for IPRS operation provided by USSEC require an auto-start electrical generator. Having said that, there may be times when electrical power is interrupted, but your fish will be fine for a considerable period of time. The aerated, mixed and flowing water established by your WWUs will continue to flow for a couple of hours and will maintain your fish. You need to act quickly to re-establish the electrical current needed by IPRS. Quickly address the problem by assuring your auto-start generator starts and is effectively operating your IPRS facility. Remember, only the WWUs attached directly to the raceway cells need be connected to the generator. Second, report the interruption to the correct persons so that the normal electrical current supply is restored as quickly as possible.

### **Can I use sinking feed? Floating feed is very expensive in my area.**

USSEC never recommends the use of sinking feed in modern aquaculture ponds. The ingredient quality and water stability are typically questionable. High-quality floating feeds have proven across many feeding trials and demonstrations that the cost of the floating diet performance in weight gain per day, survivorship, yield and fish quality is more than justified. As feed costs rise, this question still comes up occasionally even after many trials proving the utility and profitability of floating over sinking feeds. Especially on farms applying IPRS principles, better diet quality has great bearing on how much solid waste is collected, daily weight gains and water quality

in the IPRS pond. Use floating diets of excellent quality to see feed efficiency (FCR) and nutrient retention at very efficient levels.

### **I have heard duckweed, water hyacinths and other aquatic plants are effective in removing nutrients—are they recommended with IPRS?**

All plants that live in the water or at least on the water's edge are able to pull in nutrients they scavenge in their environment. However, in traditional ponds as well as IPRS ponds we have determined that the most efficient plants for absorbing nutrients from their environment and not bringing about other significant problems are planktonic plant forms. The phytoplankton we seek to establish in IPRS ponds are green plants just like terrestrial plants except they are microscopic in size! The billions of planktonic cells populating IPRS ponds are far more capable of scavenging nutrients for the pond water than any floating or rooted species. Plants like duckweed (*Lemna* species) are known for their very rapid expansion of their number and biomass. However, they are still no match for planktonic forms in either growth of their numbers, biomass or ability to absorb nutrients from the pond environment. Also, plants like duckweed and other floating plants will effectively curtail or stop water flow through the raceway cells due to clogging of confinement gate mesh. This will kill your fish.

Rooted plants behave similarly in terms of water flow degradation. Rooted plant stems and leaves create drag on water flow within the IPRS pond. They also break away from the plant base and

float eventually to the confinement gate mesh and cause clogging and reduced water flow. Some managers want to culture vegetables on floating raft structures in IPRS ponds. This is acceptable if rafts are placed in-line with planned and active water flow and located in the area where water is re-entering the raceways. That is, upstream from the raceways but not closer than 25 to 30 meters.

### **On my farm I also grow ducks, can I allow the ducks to use the IPRS pond?**

No. The organic loading from feeding fish in IPRS cells already provides a challenging organic load for the pond. No other fish (wild) or other animals are allowed use of or access to the IPRS pond.

### **How do I get control of plants which are on the pond bottom while building my IPRS?**

Often, these plants will arise as the pond bottom is exposed for construction of IPRS and need to be removed before flooding the pond. These plants can, in 2 to 3 months, develop a large biomass which will place a very large organic load on the pond if they are not removed. Some managers act preventatively and don't let these plants get started by tilling or mowing the pond bottom or applying a registered herbicide to kill the plants. Others wait until just 2-3 weeks ahead of flooding the pond.

They apply herbicide to kill the plants, let them dry for a week or 10 days and then burn the dry biomass. Remember, many herbicides kill fish even at very low concentrations.

Be sure any herbicides you use to control vegetation on pond bottom or levee are compatible with keeping fish alive and healthy. These are effective means of addressing this problem. There is probably not a single best answer but this is how managers address this unwanted vegetation in the IPRS pond.

### **I want to harvest flowers and vegetables from IPRS pond water, where can I place the plant rafts?**

To reiterate, water in the IPRS is designed to flow robustly around the pond. Nutrient levels are adequate for some plants, especially those whose leaves will be harvested rather than fruits like tomatoes, for example. Rafts for this type of culture should be placed no closer than 25 to 30 meters from the upstream end of the raceway cell. They should be placed in-line with water flow.

### **What are the main elements that make an investment in IPRS successful? What ROI should I expect?**

This is the fundamental question all those that are interested in adopting IPRS must ask and answer for themselves. IPRS is a principle driven, advanced pond aquaculture production technology that uses modern approaches to more economically produce significantly more fish volume than traditional systems do. IPRS allows operators to predictably produce 200% to 300% more yield with a reduced cost per unit.

IPRS requires use of high-quality floating (extruded) feeds, fingerlings free of disease, electric energy, and informed management to render an attractive ROI.

Ranges for ROI run from 0% to 80% depending upon local market conditions, management skills and following IPRS principles taught by USSEC staff and consultants. Typically, ROI will range from 15% to 60%, the mean approximates 35%. If your facility is designed correctly and is operated following IPRS principles, you should expect a ROI of 25% to 40%. See Section 7 in this manual for spreadsheet tools you can use to predict possible outcomes at your location.

### **Electricity in my area is very expensive. Can I make IPRS work and earn a decent ROI?**

First, IPRS is not for everyone nor is it recommended under all local conditions. It requires a significant capital investment and follow-through to be successful. In most locations, electricity is much lower in price per kWh. However, within your location and conditions in the marketplace where you plan to market your fish, an attractive ROI is still possible. Go to Section 7 and use the economic analysis template to project business possibilities you are considering.

### **What types of gear is available to purchase for setting up IPRS? Can I build it myself?**

IPRS is a relatively new technology but even so, equipment is available for purchase.

You certainly may build the IPRS equipment, structures and gear needed for your own IPRS facility. However, some of the more important gear you would do well to purchase rather than trying to build it yourself. The current equipment suppliers have been operating for several years after quite a bit of technical training, so it will be somewhat expensive for you to start from scratch to build your own gear. The main supplier is identified in this manual (See Appendix G for contact information). Further, you should contact your USSEC staff support person and let them know your interest and seek advice for moving forward. Take advantage of information gained by others — it will likely save you a lot of resources.

### **Are feeding practices for IPRS different from traditional pond feeding?**

Feeding practices used in IPRS are not very different from feeding fish in traditionally managed ponds. IPRS requires use of extruded, floating diets of a quality needed for animals in a captive environment. General diet guidelines are provided in this manual. See Section 4.6 to 4.7 for recommended feeding practices relative to achieving high levels of nutrient uptake as well as excellent gains per day. Feeding in IPRS allows more efficient use of feeds with minimal waste.

Our objective is to achieve a high level of survival, optimal gain per day and yield per cycle. IPRS provides the facility and management points necessary to routinely reach these objectives.

### **How do I determine how many fingerlings or stockers I need to stock a raceway cell? Is this the same for all species?**

Stocking density and ultimately the total number needed is determined by your desired target weight at the end of a particular production cycle. See Section 4.2 for more details.

In IPRS, for fingerling production we use a 125 kg/m<sup>3</sup> of raceway volume and our target weight per fingerling or stocker to determine the desired number per cubic meter, and therefore, the raceway cell. As an example, say you want to develop stockers for on-growing in a second year. You want to produce stockers who weigh 500 grams over 5 to 6 months. The standard size IPRS raceway cell holds 220 m<sup>3</sup> volume. So, 125kg/m<sup>3</sup> total weight / 500g target weight X 220 m<sup>3</sup> = 250 fish per cubic meter. Then, over 220 m<sup>3</sup>: 250 stockers X 220 m<sup>3</sup> of cell volume, you will need 50,000 pieces of 40-gram fingerlings per raceway cell. This is an example that might be used for grass carp or Tilapia when stocking as fingerlings in IPRS for production of advanced fish for a second period of growth. Other species may be less tolerant to crowding hence densities would be reduced. Still others may be marketable at 150-200 grams to their density might be increased.

### **How can I best hedge my investment in IPRS as fish prices are variable?**

First, spend some time talking with your market connections. They may be helpful in guiding you to an attractive price window in the market.

You may already know the best window for market entry. You might also have an advantage in culturing multiple species as a hedge against declining market pricing for a single species. Use the economic analysis template tool provided in Section 7 to consider several production and timing scenarios.

Other input costs can also be variable. The cost of feed is such a large fraction of your production cost, it should never be ignored. Finally, if you are operating a multiple cell facility, your staggered production/harvest schedule can be a major advantage in both cash flow and taking advantage of optimal market pricing.

### **What species is best for me to grow?**

Only you can answer this question. You should determine what species you can market with the best margin. Consumers of your fish should determine what you devote the most time to growing and what has the best return on investment. Local culture and market costs and pricing will guide your decisions for species selection. See Section 7 for economic analysis templates for decision making.

### **Why can't I install 2 to 3 cells in a small ¼ ha pond? Water quality in the raceway is maintained by the blower, so I don't think the fish will die.**

The number of cells you should install is completely driven by pond volume- no other factor. While you might be able to pack in 15 cells into the pond basin, the real question is how much fish production waste your pond can assimilate without killing your fish. Typically, traditionally managed ponds turn out 6 to 12 tons per ha per year depending on location.

Experienced managers can see annual yields in tropical areas at 20 to 30 tons per ha per year. IPRS facilities managed using all principles provided by USSEC staff can produce 200% to 300% above traditional systems in the same area. See Section 2.3 for a more detailed explanation of the ratios of pond volume to number of IPRS cells to install.

### **How can I be confident this will work on my rural farm?**

IPRS are currently installed in at least 18 countries around the world. This is a "farm proven" technology, not an academic project. IPRS approaches and principles have been developed over 30 years- at first on Land Grant University Experiment Stations, but beginning in 2003 to 2004 on real world farms which took the concept to commercial scale and use. Schedule a visit to a farm using IPRS in your region to get more insight. Speak with the USSEC representative in your area to gather as many facts as you can before making any decision.

### **How can I determine the volume of my ponds? I have many small ponds. Can they be re-built and consolidated?**

Determining current pond volume is not particularly difficult but does take some time. Most farm managers and operators know their farm and pond surface areas (in hectares, mu, or acres, etc.). But, they are nearly always over-estimating the current depth of pond and thus their pond volume.



Volume is calculated by determining length x width and average depth:  $L \times W \times D = \text{volume}$ . Length and width are easy enough, just measure them — even with your smartphone. Sometimes, you have irregularly shaped ponds, so it is best if you divide the pond into smaller squares, rectangles and triangles to be able to make an accurate length x width composite.

Determining average depth in a pond full of water is not so easy. To get an accurate average depth, you should probe the pond with a measuring stick or rod at several locations across the full pond bottom. In a one-hectare pond, take at least 10 depth readings. The more irregular the bottom profile, the more readings you should take for a reasonable depth accuracy. Calculate the average depth by adding together all the depth readings and divide that sum by the total number of readings. So, in our above example, assume we took 10 depth readings. Let's say our 10 depth readings sum to 23 meters, we then divide this figure by 10 readings:  $23/10 = 2.3$  meters average depth.

### **My ponds freeze over in winter. What should I do to manage IPRS in winter?**

Use of IPRS in climates where winter temperatures freeze pond surfaces, presents special challenges. Many IPRS operations are in locations where winters can be harsh. Take out all fish from cells as water temperature approaches 6-8C. The fish can be marketed at that time or stored in ponds set up for such interim storage as operators wait for market opportunities.

### **I have a fish farm with year-round growing conditions. If I adopt IPRS, what challenges and opportunities should I expect in the tropics?**

Adoption of IPRS in tropical locations brings mostly positive benefits but there are some challenges too. For benefits, your growing season is 12 months. This means, for many species, you can make 2 to 4 cycles per year. Now, some species which are slower growers or the market target is large, more days per cycle are required. With tilapia, three annual cycles are common, some get 4 cycles if, for example, they start 50 to 60 gram fingerlings and their market target is 500 grams. The larger this fingerling at stocking, the fewer days required to reach the market weight target. To make the 4 cycles per year work, you need to consider developing 50 to 60 gram fingerlings on your farm rather than relying on others for these fish. Often, they will not have them on your schedule. Also, to achieve 3 to 4 annual production cycles, best management practices have shown that reducing your target biomass per cubic meter in raceway cells pays for itself. Consider reducing yield/cubic meter to 100 to 125 in grow out cells. This reduction allows you to reach target biomass in 90 days when you start 50 to 60 gram fingerlings, use good feed and operate according to IPRS principles.

Tropical negatives are few. But, depending on location, water availability can be an issue in dry seasons. Sometimes the dry conditions bring about circumstances where only salty (brackish) water is available to replace evaporative or seepage losses.

Saline water brings about many issues with degradation of materials from corrosion and the like.

The tropics are great for growing plants, some of which are not productive or useful for IPRS facilities. Often, they create water flow degradation, organic loading from rotting vegetative materials and so forth.

Depending upon location, hurricanes or typhoons can present significant challenges if your farm location is in an area which is impacted even occasionally by such weather issues. Wind damage can be significant, and heavy rainfall instances can overtop levees, interrupt electrical service and limit access to the IPRS facility. These issues bear consideration depending on farm location and plans for dealing with such challenges.

**For more information about IPRS, contact [IPRS@ussec.org](mailto:IPRS@ussec.org).**

# APPENDIX E: IPRS Designs, Drawings and Plans

Figure 167. CAD drawing details of an IPRS facility designed to operate according to USSEC principles

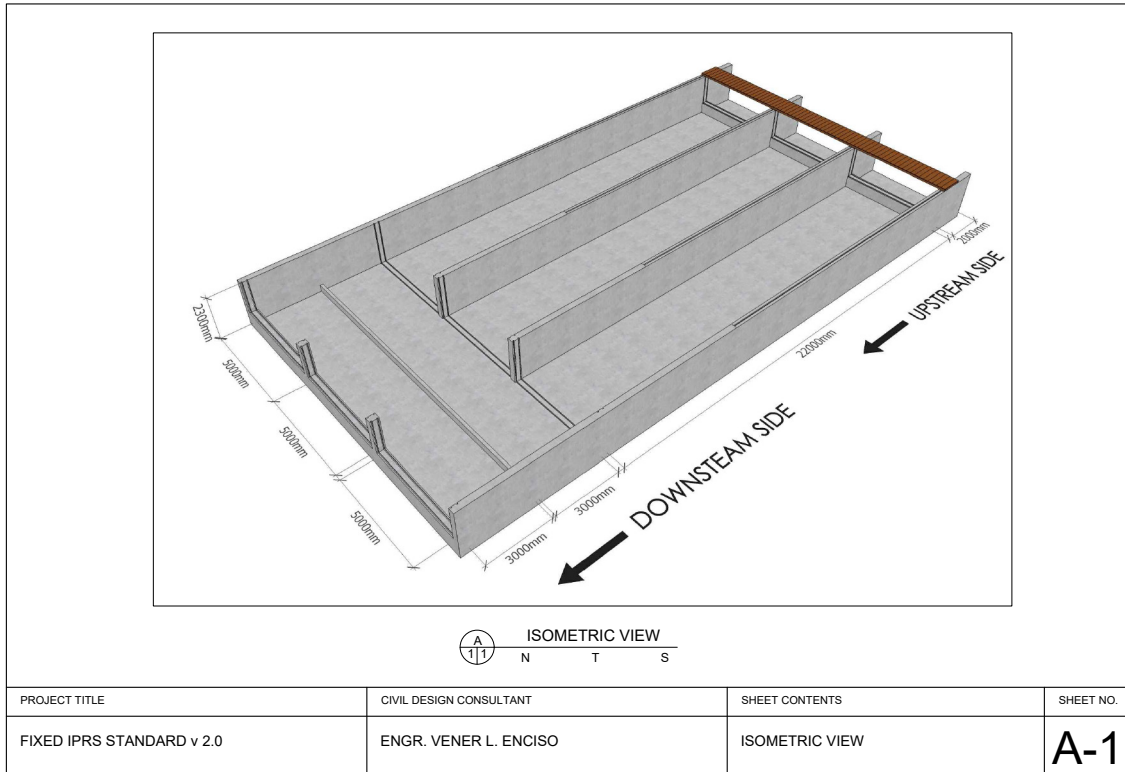
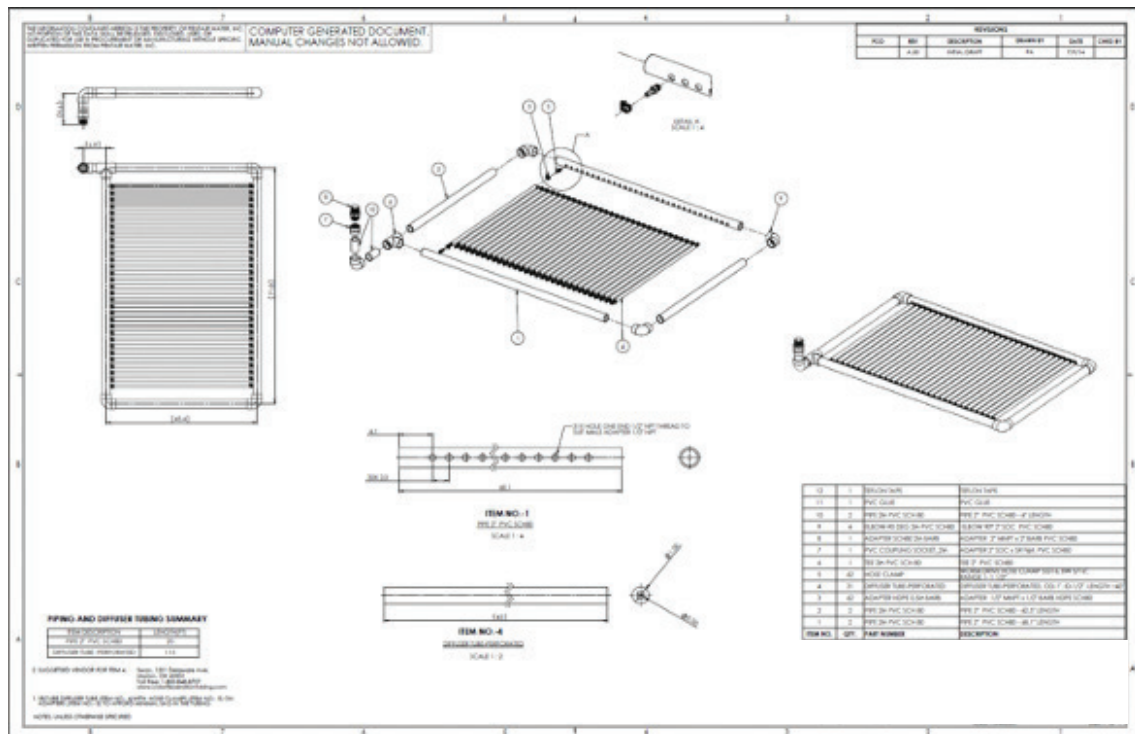


Figure 168. Drawing details for WhiteWater Unit (WWU) frame and hood



To view more CAD drawings, visit [ussec.org/iprs](http://ussec.org/iprs)



# APPENDIX F:

## References and Literature Citations

### Peer Reviewed Journal Articles and Books

1. Acuicultura en Colombia, Cadena de la Acuicultura, Direccion de Cadenas Pecuarías, Pesqueras y Acuicolas. Marzo de 2021.
2. Arana, E., J. Stacy, F. Sanabria, J. A. Chappell, Commercial demonstration in floating In-Pond Raceways System with red tilapia, Mission UpReach, Honduras. 2019 LAQUA, Book of Abstracts page 16, San Jose Costa Rica.
3. Arana, E., Verena Fuentes, Gilbert Thiriez, Jairo Amezcuita, Jesse Chappell, Ph.D., First trial growing vaccinated Nile tilapia in IPRS in Colombia. Global Aquaculture Alliance, April. 2020.
4. Arana, E., Canseco, R., Martinez, G., Amezcuita, J. Evaluating Commercial, intensive production of Nile Tilapia in IPRS. Global Aquaculture Alliance, Sep. 2020.
5. Arana E., Jesse Chappell, Terry Hanson, Jairo Amezcuita, Francisco Romellon, Arturo Quiñonez, Gustavo Lopez, Herbert Quintero TILAPIA FARMING: USE OF IN-POND RACEWAYS SYSTEM (IPRS) IN MEXICO. LAQUA 18, Book of Abstracts, page 20.
6. Arana, E., Chappell, J.A. PhD; Amesquitita, J.; Pedroza, L. Quintero, H. PhD Culture of Red Tilapia in Raceways in Ponds. Global Aquaculture Alliance, Feb. 2019.
7. Arana, E., J. A Chappell, T. R. Hanson, J. Amezcuita, F. Romellon, A. Quiñonez, G. Lopez and H. Quintero, 2018. Commercial demonstration of In-Pond raceways. Global Aquaculture Advocate.
8. Best Aquaculture Practices – BAP Certified Aquaculture Producers. Producers, FEDEACUA. National Technical Analysis Secretariat for Aquaculture– MADR – 2021.
9. Bott, L.B., Roy, L.A., Hanson, T.R., Chappell, J., Whitis, G.N., 2015. Research verification of production practices using intensive aeration at a hybrid catfish operation. North Am. J. Aquac. 77, 460–470.
10. Boyd, C.E., 2012. Water Quality, in: J. S. Lucas, and P. C. Southgate, Editors. Aquaculture: Farming Aquatic Animals and Plants. Blackwell Science Publ, Oxford., pp. 52–83.
11. Boyd, C.E., 1998. Water Quality for Pond Aquaculture. Research and Development Series No. 43. International Center for Aquaculture and Aquatic Environments, Alabama Agricultural Experiment Station, Auburn University, Alabama, pp. 37.
12. Boyd, C.E., 1990. Water quality in ponds for aquaculture. Agriculture Experiment Station, Auburn University-Alabama, pp.482.
13. Boyd, C.E., Hanson, T., 2010. Dissolved oxygen concentrations in pond aquaculture. Glob. Aquac. Advocate pp. 5.
14. Boyd, C.E., Tucker, C.S., 1998. Pond Aquaculture Water Quality Management. Kluwer Academic Publishers, Boston-MA, pp.685.
15. Brinker, A. 2007. Guar gum in rainbow trout (*Oncorhynchus mykiss*) feed: the influence of quality and dose on stabilization of faecal solids. Aquaculture 267 (2007) pp 315–327.
16. Brown, T.W., C.S. Tucker, B.L. Rutland. 2016. Performance evaluation of four different methods for circulating water in commercial-scale, split-pond aquaculture systems. Aquacultural Engineering. Vol. 70 January, pp. 33-41.
17. Brown, T.W., Boyd, C.E., Chappell, J.A., 2015. Organic carbon and dissolved oxygen budgets for a commercial-size, In-pond Raceway System: Organic carbon and dissolved oxygen budgets for a commercial-size. J. World Aquac. Soc. 46, 539–548.
18. Brown, T.W., Hanson, T.R., Chappell, J.A., Boyd, C.E., Wilson, D.S., 2014. Economic feasibility of an In-Pond Raceway System for commercial catfish production in West Alabama. North Am. J. Aquac. 76, 79–89.
19. Brown TW, Boyd CE, Chappell JA. 2012. Approximate Water and Chemical Budgets for an Experimental, In-pond Raceway System. Journal of the World Aquaculture Society. 43(4):526-537.
20. Brown, T.W., Chappell, J.A., Boyd, C.E., 2011. A commercial-scale, in- pond raceway system for Ictalurid catfish production. Aquac. Eng. 44, 72–79.

For a full list of references, visit [ussec.org/iprs](http://ussec.org/iprs)



21. Brune, D.E., C. Tucker, M. Massingill, J. Chappell. Partitioned Aquaculture Systems. Chapter 13 in Aquaculture Production Systems. John Wiley & Sons.
22. Brune, D. E., G. Schwartz, A.G. Eversole, J.A. Collier, T.E. Schwedler. 2004. Partitioned aquaculture systems. Chapter 19 in *Developments in Aquaculture and Fisheries Science*. Vol 34, pp. 561-584.
23. D'Abramo, L.R., Hanson, T.R., Kingsbury, S.K., Steeby, J.A., Tucker, C.S., 2013. Production and Associated Economics of Fingerling-to-Stocker and Stocker-to-Grow-Out Modular Phases for Farming Channel Catfish in Commercial-Size Ponds. *North Am. J. Aquac.* 75, 133-146.
24. D'Abramo, L.R., J.A. Steeby, T.R. Hanson, and P.D. Gerard. 2006. "Evaluation of a Fingerling to Stocker Phase as Part of a New Production Strategy for the Commercial Farming of Channel Catfish *Ictalurus punctatus*." *North American Journal of Aquaculture*, 69 (1) January: 22-35.
25. Engle, C.R., 2010. *Aquaculture Economics and Financing: Management and Analysis*. Wiley-Blackwell pp.260.
26. Engle, C.R., 2012a. Introduction to Financial Management of Aquaculture Businesses. *South. Reg. Aquac. Cent. SRAC Publication 4400*.
27. Engle, C.R., 2012b. Determining the Profitability of an Aquaculture Business: Using Income Statements and Enterprise Budgets. *South. Reg. Aquac. Cent. SRAC 6*.
28. FAO, United Nations Food and Agricultural Organization, Fisheries Division, National Aquaculture Sector Overview-Mexico.
29. Gosh, K., T.R. Hanson, D. Drescher, D. Robinson, W. Bugg, N. Chatakondi, G. Kumar, C. Jeffers, R.A. Dunham. 2021. Economic effect of hybrid catfish (Channel Catfish male x Blue Catfish female) Growth Variability on Traditional and Intensive Production Systems. *North American Journal of Aquaculture*. Pp. 1-17.
30. Hanson, T.R., Bott, L.B., Chappell, J.A., Whitis, G.N., Kelly, A.M., Roy, L.A., 2020. Research verification of single and multiple-batch production practices at two Channel catfish farms in Western Alabama. *North Am. J. Aquac.* 1-10.
31. Jolly, C.M., H.A. Clonts. 1993. *Economics of aquaculture*. Food Products Press, Binghamton, NY, pp. 319.
32. Kay, R.D., Edwards, W.M., Duffy, P.A., 2016. *Farm Management*, 8th ed. McGraw Hill Education, New York- NY, pp. 466.
33. Li, W., X. Cheng, J. Xie, Z. Wang, D. Yu. 2019. Hydrodynamics of an in-pond raceway system with an aeration plug-flow device for application in aquaculture: an experimental study. *The Royal Society Publishing*, Published: 10 July 2019.
34. Lovell, T. 1989. *Nutrition and Feeding of Fish*. An AVI Book, Von Nosrand Reinhold, New York, NY. Pp. 260.
35. Masser, M., 2017. Tilapia Co-culture in Cages and In-pond Raceways, in: *Tilapia in Intensive Co-Culture*. John Wiley & Sons, Ltd., pp. 148- 155.
36. Masser, M., Dunham, R., 1998. *Production of Hybrid Catfish*. *South. Reg. Aquac. Cent. SRAC Publication No. 190*, pp.6.
37. Masser, M.P., 2004. Cages and in-pond raceways, in: *Biology and Culture of Channel Catfish*. Elsevier, New York, pp. 530-545.
38. Masser, M.P., Lazur, A., 1997. *In- Pond Raceways*. *South. Reg. Aquac. Cent. SRAC pp.8*.
39. Roy, L.A., Hanson, T.R., Bott, L.B., Chappell, J.A., 2019. Production and economic comparison of single versus multiple harvests of hybrid catfish in a commercial In-pond raceway system in West Alabama targeting two Market Outlets." *Journal of Southeastern Association of Fish and Wildlife Agencies* 6:58-66.
40. Torrans, L., Ott, B., 2019. Effects of Density on Production of Hybrid Catfish in Intensively Aerated Earthen Ponds where Dissolved Oxygen is Not a Limiting Factor. *North Am. J. Aquac.* 81, 417-423.
41. Tucker, C.S., 1991. Water Quantity and Quality Requirements for Channel Catfish Hatcheries. *South. Reg. Aquac. Cent. SRAC Publication No. 461*, pp. 7.
42. Tucker, C.S., J. A. Hargreaves, editors. 2004. *Biology and culture of channel catfish*. Elsevier, Amsterdam, The Netherlands. Pp. 676.

43. Wang, Y., Xu, G., Nie, Z., Shao, N., Li, Q., Xu, P., 2019. Growth performance of Bluntnose black bream, Channel catfish, Yellow catfish, and Largemouth bass reared in the In-Pond Raceway recirculating culture system. *North Am. J. Aquac.* 81, 153–159.
44. Welker, R.L., K. Liu, K. Overturf, J. Abernathy, F.T. Barrows. 2021. Effect of soy protein products and gum inclusion in feed on fecal particle size profile of rainbow trout. *Aquaculture Journal*. Vol 1, issue 1.
- PhD Dissertations and Master's Theses**
45. Bott, LB 2015. Catfish research verification trials in west Alabama using channel catfish (*Ictalurus punctatus* and hybrid catfish (*Ictalurus punctatus* x *Ictalurus furcatus*). Master's Thesis. School of Fisheries, Aquaculture and Aquatic Sciences, Auburn University.
46. Brown, TW. 2010. Intensive Culture of Channel Catfish *Ictalurus punctatus* and Hybrid Catfish *Ictalurus punctatus* x *Ictalurus furcatus* in a Commercial-Scale, In-pond Raceway System. Doctoral Dissertation. School of Fisheries, Aquaculture and Aquatic Sciences, Auburn University, US.
47. Courtwright, C., 2013. Best management practices For West Alabama catfish production: Creating Profitability through efficiency, consistency, and quality. Doctoral Dissertation. School of Fisheries, Aquaculture and Aquatic Sciences, Auburn University, US pp 261.
48. Fern, M.P. 2014. An economic comparison of three intensive fish production systems. Master's Thesis. School of Fisheries, Aquaculture and Aquatic Sciences, Auburn University.
49. Fullerton, G. 2016. Economic viability of floating in-pond raceway systems for commercial hybrid catfish production. Master's Thesis. School of Fisheries, Aquaculture and Aquatic Sciences, Auburn University.
50. Holland, L.W. 2016. Comparing economic returns of dissolved oxygen management in commercial catfish production. Master's Thesis. School of Fisheries, Aquaculture and Aquatic Sciences, Auburn University.
51. Regan, RM. 2011. Bio-economic factors affecting feasibility of floating in-pond raceway systems: a STELLA modeling approach. Master's Thesis. School of Fisheries, Aquaculture and Aquatic Sciences, Auburn University.
52. Stuckey GL 2015. Comparison of *Ictalurid* hybrid crosses (*Ictalurus punctatus* x *Ictalurus furcatus*) in floating in-pond raceway systems. Master's Thesis. School of Fisheries, Aquaculture and Aquatic Sciences, Auburn University.
- Presentations, Trade Journals and Magazines**
53. Bott, L.B., Roy, L.A., Hanson, T., 2014. Chemical treatment costs reduced with in- pond raceway systems. *Glob. Aquac. Advocate* 6.
54. Brown TW, Chappell JA. 2011. A commercial-scale, in-pond raceway system for *Ictalurid* catfish production. *Aquacultural Engineering*. 44(2011):72-79.
55. Brown TW, Chappell JA, Hanson TR. 2010. In-pond Raceway System Demonstrates Economic Benefit for Commercial Catfish Production. *Global Aquaculture Advocate*. 13(4):18-21.
56. Davis, A., F. Kubitz, J. Chappell, T. Hanson. 2017. Production of hybrid catfish using In-Pond Raceway System. Poster presentation at Aquaculture America, San Antonio, Texas.
57. Hanson, T. 2015. An Economic Look at the In-Pond Raceway System – 2013 Research. Presentation to visiting Chinese delegation at Auburn University, School of Fisheries, Aquaculture and Aquatic Sciences, January 19-20.
58. Kubitz, F., Chappell, JA, Hanson, TR, Arana, E. 2017. The promise of In-Pond Raceway Systems, part 1. *Global Aquaculture Alliance*. March 19.
59. Kubitz, F., Chappell, JA, Hanson, TR, Arana, E. 2017. The promise of In-Pond Raceway Systems, part 2. *Global Aquaculture Alliance*. March 24.
60. Roy L, Hemstreet W, Brown T. 2013. Catfish Disease Cases in In-Pond Raceway Systems in Alabama: 2008 -2013. *The Catfish Journal*. 27(4): 17, 21.
61. Roy, LA. 2016. Commercial implementation of in-pond raceway system. *Global Aquaculture Alliance*. January 18.

## APPENDIX G: Contacts for Technical Assistance, Equipment, Feed, U.S. Soy

For more information about IPRS,  
contact [IPRS@ussec.org](mailto:IPRS@ussec.org).

### Approved IPRS Equipment Suppliers:

#### China:

XuanCheng Dingxing Environmental  
Protection Engineering Co., Ltd.  
Suzhou Dingxing Swan Aquatool  
Co., Ltd

**Contact:** Mr. Tiger Ge

**Phone:** 0086 13914076399

**Location:** No 433 Liangang road  
High-Tech district Suzhou city  
Jiangsu Province China 215129

**Email:** [dingxinghuanbao@hotmail.com](mailto:dingxinghuanbao@hotmail.com)

#### India:

Prasidhi Imports and Exports

**Contact:** Mr. Y. Siddhartha Reddy,  
Director

**Phone:** +91 9003150505

**Location:** 15/952, 2nd Lane,  
Venkatarampuram, Beside  
Mini Bypass Road, Nellore, A.P,  
India-524002

#### Pakistan:

Pioneer Aqua's

**Contact:** Mr. Kamran Maqsood,  
Director

**Location:** Plot # 323-324 Punjab  
Industrial Estates, Phase 2, MULTAN,  
PAKISTAN.

**Phone:** +92 300 7339909

#### Bangladesh:

Ferdous Trading

**Contact:** Syed Fardos Murad,  
Managing Partner

**Location:** 51 West Tejturi Bazar,  
Tejgaon, Dhaka 1215. Bangladesh.

**Phone:** +8801773392805,  
+880248112139

#### United States of America:

Aero-Tube diffuser tubing/  
Sweetwater regenerative blowers:

**Location:** Colorite Corp./Swan Hose  
Corp. 1201 Delaware Ave, Marion, OH  
43302 USA

**Email:** [aeration@swanhose.com](mailto:aeration@swanhose.com)

**Phone:** 1-800-848-8707

Aero-Tube Global Account Manager

**Contact:** Harrison Copper

**Location:** 7840 Roswell Road Sandy  
Springs, GA 30350

**Mobile phone:** 641-660-8889

**C.S.:** 1-800-848-4673

**Email:** [Harrison.copper@swanhose.com](mailto:Harrison.copper@swanhose.com)

**Website:** [www.aero-tube.com](http://www.aero-tube.com)

Aquatic Equipment and Design

**Contact:** Huy Tran

**Location:** 30924 Suneagle Drive  
Suite #210, Mount Dora, FL 32757  
USA

**Phone:** 1-407-995-6490

**Website:** <https://www.aquaticed.com/>

Water Management Technologies/  
Innova Sea

**Contact:** Terry McCarthy

**Location:** 17445 Opportunity Avenue  
Baton Rouge, LA, 70817 USA

Land-Based Aquaculture

**Phone:** 225-755-0026

Pentair Corporation

**Phone:** 1-407-886-3939

**Website:** [www.pentairaes.com](http://www.pentairaes.com)

## APPENDIX H: Potential variations and R&D of IPRS

The USSEC Aquaculture teams and other researchers are working on additional approaches and methods to apply IPRS in a broader context. This includes development of floating systems and systems for saline waters, among others. Additional explorations for enhanced settled solids collection and removal are being considered and made. As more information becomes available, which have firm foundations for commercial application, we will be pleased to communicate them through USSEC Regional representatives and personnel.

# APPENDIX I:

## Link between IPRS and U.S. Soy Farmers

### Why is IPRS important to U.S. Soy Farmers?

The IPRS approach to pond aquaculture allows the farm operator to produce annual yields 200% to 300% greater than from traditionally managed ponds. IPRS ponds use more feed than traditional ponds and U.S. Soy provides a high quality, nutritionally sound and certified sustainable input for aquaculture diets.

### The important link between high quality feeds and IPRS performance

Feed quality is determined largely by the quality of ingredients used in its manufacture. It is generally not possible to make any high-quality fish diet with less than top quality ingredients. Likewise, if the wrong feedstuffs are used in feed milling for a particular fish species or life stage of the fish, growth performance and survival will likely decline.

High quality ingredients must be formulated to be complete and nutritionally balanced for optimal animal efficiency and performance.

When any animal is cultured in confinement, diet quality and completeness is extremely important to achieve optimum performance efficiencies required for profitability. Considering swine, poultry or aquatic species, diet quality is critical to the enterprise return on investment (ROI) and profitability.

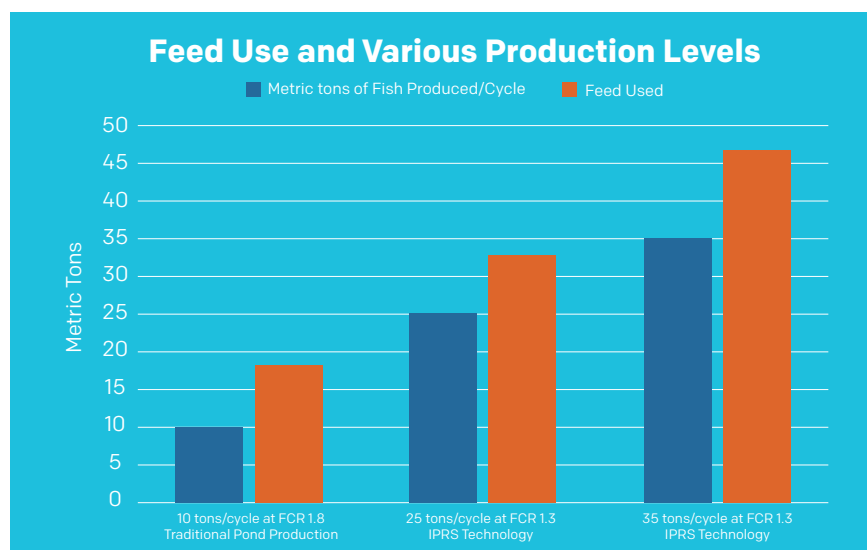
In production of any aquatic species, feed utilization efficiency and nutrient retention (particularly for proteins) has a direct impact on the water environment in which they live. The better the environmental quality (water quality), the better the

efficiency and performance of the fish. The preeminent water scientist, Dr. C.E. Boyd has stated this point in several project reports (See figure 171). The graphic below shows when dissolved oxygen (DO) levels in the production system drops below 3.0 mg/l, significant deterioration of FCR is a direct result.

Further, Boyd and many other researchers have established that for each kilogram of feed consumed by fish, about 75% of it is excreted in different forms into the water (Boyd and Hanson, 2010). This points to why the production of fish in ponds has its limitations. Pond production is limited by the quality of water in which the fish are cultured. The major element impacting pond water quality, directly and indirectly, is the feed offered to the fish.

For use in IPRS, only extruded complete and balanced diets are recommended. If poor quality feed is fed to the fish or if over feeding is routinely practiced, water quality deteriorates. An illustrative example of this is simply comparing FCR of 2.0:1 versus 1.3:1 as to how much waste is excreted under each scenario. With 75% of feed excreted as waste, consider that FCR of 2.0:1 will cause the release of 1.5 kg of organic material (liquid, solid and gas) into the pond water for each kilogram of weight gain. By contrast, an FCR of 1.3 typically found in IPRS, shows a release of only 975 grams for the same kilogram of weight gained by the fish. Feeding fish correctly with a high-quality feed in a system that allows efficient feed conversion reduces the organic load on the pond and increases returns to the enterprise.

**Figure 170.** Effect of IPRS on fish produced and feed used per cycle





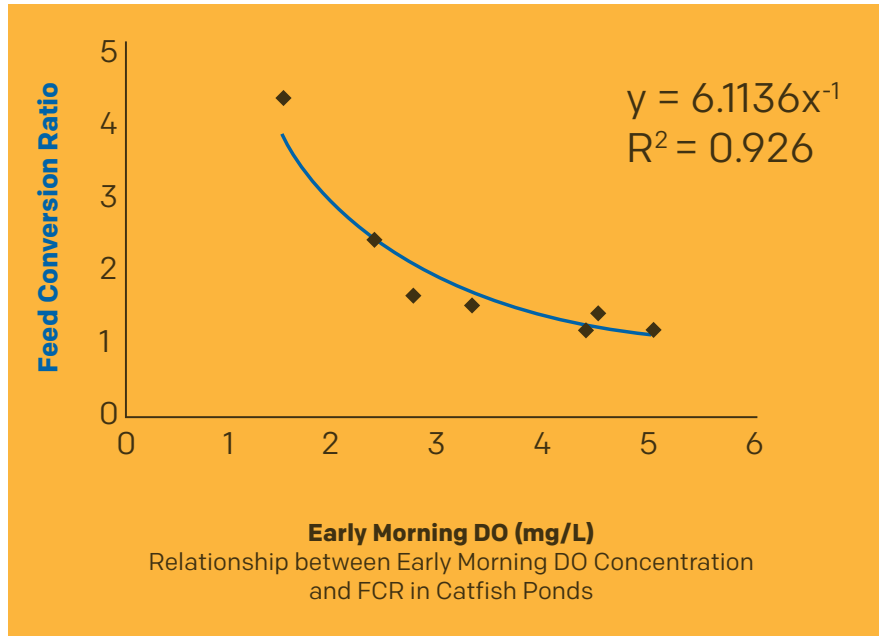
In this case, improving the FCR from 2.0 to 1.3 and the feed cost per unit gain is reduced by 35%.

**IPRS also offers additional improvements in processing with the organic load because it incorporates:**

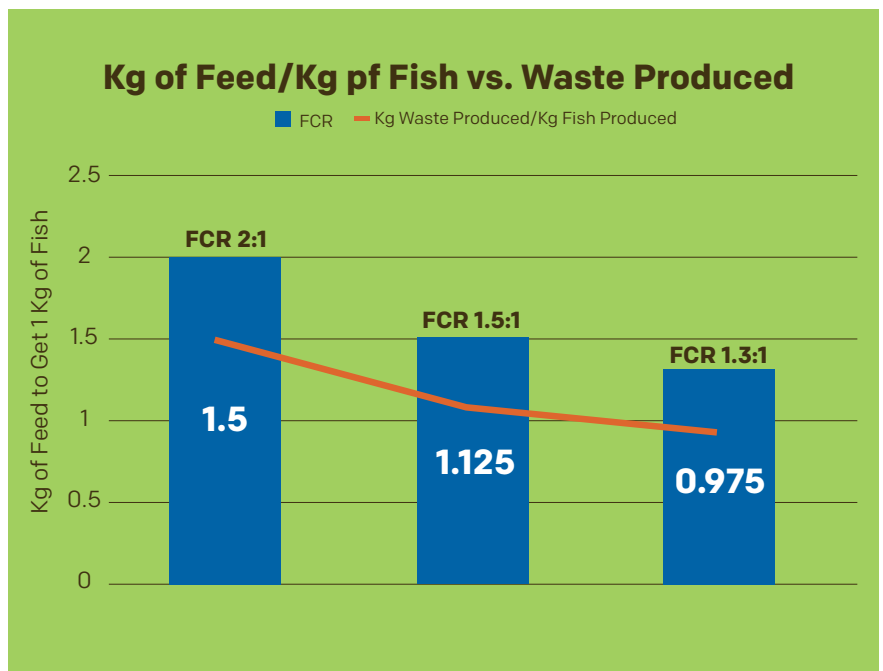
- Flowing water
- Continual mixing and aeration
- The removal of much of the solid manure produced by the fish
- The opportunity to add a filter feeding fish in the open portion of the pond. These elements combine to improve and accelerate the assimilation and eliminate the organic loading of the pond from high levels of feeding.

It should be noted that one of the key driving principles of IPRS and any other culture system for animals or plants is to provide the best possible environmental and growing conditions for the species for it to achieve its genetic potential. Using IPRS, we seek this objective.

**Figure 171.** C.E. Boyd graphic FCR as related to DO levels



**Figure 172.** Fish waste produced varies with FCR



# APPENDIX J:

## USSEC Trial Diet Formulations

### Several Species with Different Dietary Requirements

**Figure 173.** USSEC trial diet formulation for rainbow trout (48/10)\*

Ingredients	Amount %
Soy protein concentrate (SPC)	25.00
Corn gluten meal	7.25
Blood meal, spray dried	7.50
Fish meal, anchovy	20.00
Hydrolyzed fish protein	5.00
Wheat flour	19.75
Fish oil	10.00
Soy oil	1.50
Soy lecithin	1.50
Vitamin premix-F2	0.50
Mineral premix F-1	0.25
DL-methionine (99%)	0.08
L-lysine HCL (98.5%)	0.15
Taurine (95%)	1.00
Sodium chloride (salt)	0.03
Choline chloride (60%)	0.06
Stay C (35%)	0.06
Ethoxyquin - antioxidant	0.02
Solis MOS - mycotoxin binder	0.20
Mold inhibitor	0.10
Carophyll pink (10% astaxanthin)	0.05
<b>Total</b>	<b>100</b>

**Figure 174.** USSEC trial diet formulation for largemouth bass and snakehead (45/8)\*

Ingredients	Amount %
Soybean meal (certified U.S. origin)	12.00
Soy protein concentrate (SPC)	19.00
Corn gluten meal	7.50
Blood meal, spray dried	6.00
Fish meal, anchovy	14.00
Hydrolyzed fish protein	5.00
Wheat flour	27.00
Calcium phosphate mono (21%P)	0.50
Fish oil	4.90
Soy lecithin	1.50
Vitamin premix-F2	0.50
Mineral premix F-1	0.25
Calcium carbonate (limestone)	0.21
L-lysine HCL (98.5%)	0.20
Taurine (95%)	1.00
Choline chloride (60%)	0.09
Stay C (35%)	0.03
Ethoxyquin - antioxidant	0.02
Solis MOS - mycotoxin binder	0.20
Mold inhibitor	0.10
<b>Total</b>	<b>100</b>

\*Denotes (Total Protein/Total Lipid)

**Figure 175.** USSEC trial diet formulation for tilapia and channel catfish fingerlings (36/7)\*

Ingredients	Amount %
Soybean meal (certified U.S. origin)	36.00
Soy protein concentrate (SPC)	6.25
Corn gluten meal	7.00
Blood meal, spray dried	4.00
Poultry meal (pet food grade)	6.00
Wheat flour	20.00
Wheat midds	10.25
Calcium phosphate mono (21%P)	1.60
Fish oil	1.00
Soy oil	3.50
Soy lecithin	1.50
Vitamin premix-F2	0.50
Mineral premix F-1	0.25
Calcium carbonate (limestone)	1.25
DL-methionine( 99%)	0.14
L-lysine HCL (98.5%)	0.10
Sodium chloride (salt)	0.28
Choline chloride (60%)	0.03
Stay C (35%)	0.03
Ethoxyquin - antioxidant	0.02
Solis MOS - mycotoxin binder	0.20
Mold inhibitor	0.10
<b>Total</b>	<b>100</b>

**Figure 176.** USSEC trial diet formulation for tilapia & channel catfish grow-out (32/6)\*

Ingredients	Amount %
Soybean meal (certified U.S. origin)	38.00
Corn gluten meal	5.00
Blood meal, spray dried	3.00
Poultry meal (pet food grade)	5.00
Wheat flour	10.00
Wheat midds	30.00
Calcium phosphate mono (21%P)	1.40
Fish oil	1.00
Soy oil	2.50
Soy lecithin	1.50
Vitamin premix-F2	0.50
Mineral premix F-1	0.25
Calcium carbonate (limestone)	1.22
DL-methionine (99%)	0.14
L-lysine HCL (98.5%)	0.14
Stay C (35%)	0.03
Ethoxyquin - antioxidant	0.02
Solis MOS - mycotoxin binder	0.20
Mold inhibitor	0.10
<b>Total</b>	<b>100</b>

\*Denotes (Total Protein/Total Lipid)

**Figure 177.** USSEC trial diet formulation for grass carp grow-out (32/3)\*

Ingredients	Amount %
Soybean meal (certified U.S. origin)	43.00
Corn gluten meal	7.00
Blood meal, spray dried	3.00
Wheat flour	10.00
Wheat midds	29.50
Calcium phosphate mono (21%P)	2.00
Fish oil	1.00
Soy lecithin	1.50
Vitamin premix-F2	0.50
Mineral premix F-1	0.25
Calcium carbonate (limestone)	1.25
DL-methionine( 99%)	0.13
L-lysine HCL (98.5%)	0.15
Sodium chloride (salt)	0.37
Stay C (35%)	0.03
Ethoxyquin - antioxidant	0.02
Solis MOS - mycotoxin binder	0.20
Mold inhibitor	0.10
<b>Total</b>	<b>100</b>

\*Denotes (Total Protein/Total Lipid)

**Figure 178.** USSEC trial diet formulation for pangasius grow-out (28/4)\*

Ingredients	Amount %
Soybean meal (certified U.S. origin)	31.50
Corn gluten meal	3.00
Blood meal, spray dried	2.50
Poultry meal (pet food grade)	3.00
Wheat flour	15.00
Wheat midds	37.50
Calcium phosphate mono (21%P)	1.50
Fish oil	1.00
Soy oil	0.50
Soy lecithin	1.50
Vitamin premix-F2	0.50
Mineral premix F-1	0.25
Calcium carbonate (limestone)	1.25
DL-methionine( 99%)	0.13
Sodium chloride (salt)	0.52
Stay C (35%)	0.03
Ethoxyquin - antioxidant	0.02
Solis MOS - mycotoxin binder	0.20
Mold inhibitor	0.10
<b>Total</b>	<b>100</b>

**Figure 179.** Vitamin and mineral premix formulations for USSEC feeding trial diets. Quantities of vitamins and minerals are per kilogram of premix.

**USSEC Vitamin Premix F-2**

Ingredient	Unit	Amount
Vitamin A	IU/kg	1,200,000
Vitamin D3	IU/kg	200,000
Vitamin E	IU/kg	20,000
Vitamin K	mg/kg	0
Vitamin C	mg/kg	0
Biotin	mg/kg	40
Choline	mg/kg	0
Folic acid	mg/kg	1,800
Inositol	mg/kg	0
Niacin	mg/kg	40,000
Pantothenate	mg/kg	20,000
Pyridoxine (B6)	mg/kg	5,000
Riboflavin (B2)	mg/kg	8,000
Thiamin (B1)	mg/kg	8,000
Vitamin B12	mcg/kg	2,000
Ethoxyquin	mg/kg	50

**USSEC Mineral Premix F-1**

Ingredient	Unit	Amount
Iron	ppm	40,000
Manganese	ppm	10,000
Copper	ppm	4,000
Zinc	ppm	40,000
Iodine	ppm	1,800
Cobalt	ppm	20
Selenium	mg/kg	0



**USSEC Calculated Nutrient Profile of  
U.S. Soy-based (32/3) Trial Diet**

Nutrient	Amount	Unit
DE fish	2294.55	kcal/kg
NFE	41.96	%
Starch	18.74	%
*Protein	32.12	%
Protein, dig.	30.2	%
Fish protein	0	%
Soy protein	18.06	%
Soy NFE	12.17	%
*Fat	3.1	%
W 3	0.3	%
W 6	1.02	%
Fiber	2.71	%
*Ash	6.03	%
Calcium	0.94	%
Phos avail	0.58	%
Iron	6175.3	ppm
Copper	33.2	ppm
Zinc	155.25	ppm
Selenium	0.91	ppm
Moisture	11.15	%
Vitamin C	105	mg/kg
Choline	1992.66	mg/kg
Ethoxyquin	136.48	mg/kg
Arginine	1.89	%
Lysine	1.82	%
Methionine	0.6	%
Meth+Cyst	1.09	%
Threonine	1.23	%
Tryptophan	0.36	%
Taurine	0	%

**USSEC Calculated Nutrient Profile of  
U.S. Soy-based (32/6) Trial Diet**

Nutrient	Amount	Unit
DE fish	2536.67	kcal/kg
NFE	40.1	%
Starch	18.3	%
*Protein	32.12	%
Protein, dig.	30.01	%
Fish protein	0	%
Soy protein	16.1	%
Soy NFE	10.85	%
*Fat	6.12	%
W 3	0.48	%
W 6	2.37	%
Fiber	2.56	%
*Ash	5.53	%
Calcium	0.97	%
Phos avail	0.5	%
Iron	5218.8	ppm
Copper	30.43	ppm
Zinc	156.25	ppm
Selenium	0.88	ppm
Moisture	10.68	%
Vitamin C	105	mg/kg
Choline	2359.52	mg/kg
Ethoxyquin	136.48	mg/kg
Arginine	1.91	%
Lysine	1.82	%
Methionine	0.6	%
Meth+Cyst	1.1	%
Threonine	1.21	%
Tryptophan	0.35	%
Taurine	0	%

\*Denotes (Total Protein/Total Lipid)

**USSEC Calculated Nutrient Profile of  
U.S. Soy-based (28/4) Trial Diet**

<b>Nutrient</b>	<b>Amount</b>	<b>Unit</b>
DE fish	2255.2	kcal/kg
NFE	44.83	%
Starch	20.74	%
*Protein	28.06	%
Protein, dig.	26.31	%
Fish protein	0.00	%
Soy protein	13.55	%
Soy NFE	9.80	%
*Fat	4.04	%
W 3	0.33	%
W 6	1.36	%
Fiber	3.32	%
*Ash	5.90	%
Calcium	0.94	%
Phos avail	0.50	%
Iron	501.04	ppm
Copper	23.75	ppm
Zinc	154.09	ppm
Selenium	0.90	ppm
Moisture	10.95	%
Vitamin C	105.00	mg/kg
Choline	2065.88	mg/kg
Ethoxyquin	136.48	mg/kg
Arginine	1.63	%
Lysine	1.42	%
Methionine	0.50	%
Meth+Cyst	0.96	%
Threonine	1.00	%
Tryptophan	0.34	%
Taurine	0.00	%

## **APPENDIX K: Disclaimer**

This technology is in perpetual development and to date these are the best approaches known. To get the best anticipated results stated the operator must follow the standards and principles, but this does not guarantee success as there are too many possible variables. Contact your USSEC representative with questions and for more information at [IPRS@USSEC.org](mailto:IPRS@USSEC.org).

\*Denotes (Total Protein/Total Lipid)



For more information about IPRS, contact [IPRS@ussec.org](mailto:IPRS@ussec.org).

